

Reliable diagnosis. Time saving repairs.
Bosch diagnostics and service parts.

From a single source:
 Diagnostics, parts and services.
 Bosch has a complete program available
 which increases efficiency and quality in the
 workshop's daily work.
 The service parts from the globally active
 development expert and leading manu-
 facturer of automotive system technology
 are in renowned Bosch OE quality.
 Competence and quality: Assuring your
 workshop's future success.



2014 | 2015



Bosch parts fast and easy on:
www.bosch-automotive-catalog.com

2014 | 2015



BOSCH

☎ 1987 720 034/201404

AA/MKI2 – 04.2014 – Int

© 2014
 Robert Bosch GmbH
 Automotive Aftermarket
 Postfach 41 09 60

Token fee: € 5,00

www.bosch.de/aad

Editorial closing: 15.02.2014
 Subject to change without notice.
 Please direct questions and com-
 ments to our Authorized
 Representative in your country.
 This edition supersedes all
 previous editions.



BOSCH



BOSCH



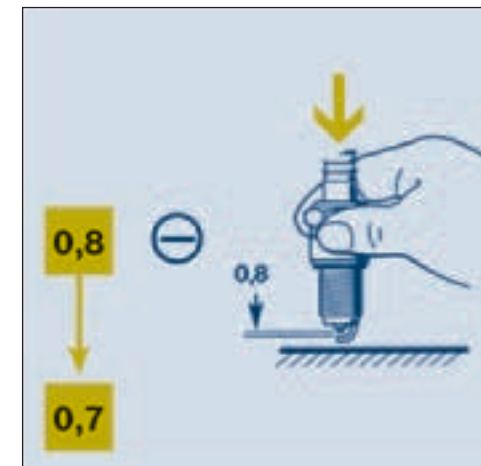
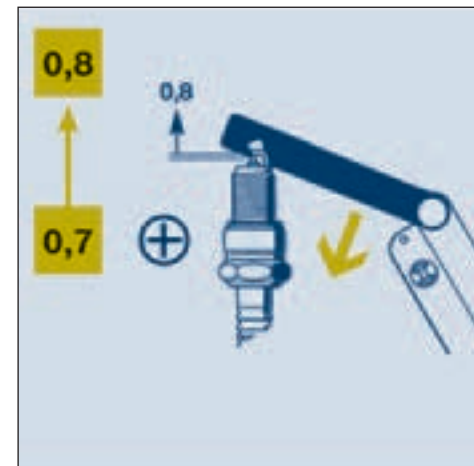

de

Vorgeschriebener Elektrodenabstand

Wenn Zündkerzen mit dem vorgeschriebenen Elektrodenabstand nicht verfügbar sind, muss der Elektrodenabstand nachgestellt werden. Dazu empfehlen wir die Benutzung der Bosch-Zündkerzenlehre.

en

Specified electrode gap

If spark plugs with the specified electrode gap are not available, the electrode gap must be adjusted. For this we recommend using the Bosch spark plug gage.

fr

Ecartement prescrit des électrodes

Si les bougies présentent l'écartement des électrodes prescrit ne sont pas disponibles, l'écartement doit être rajusté. Nous recommandons d'utiliser pour ce faire la jauge pour bougies d'allumage Bosch.

it

Distanza elettrodi prescritta

Qualora non siano disponibili candele d'accensione con la distanza elettrodi prescritta, la distanza elettrodi deve essere registrata. A tale scopo consigliamo l'impiego del calibro Bosch per candele d'accensione.

es

Separación entre electrodos prescrita

Si no hay disponibles bujías con la separación entre electrodos prescrita, será necesario reajustar la separación entre los electrodos. Recomendamos utilizar para ello la galga para bujías de encendido Bosch.

de

Der Funke, der immer sicher zündet: Zündkerzen von Bosch – Pionier für Zündkerzen seit über 111 Jahren

en

The spark that never fails: Spark plugs from Bosch – Pioneer in spark plugs for over 111 years

fr

L'étincelle qui jaillit sans jamais faillir : bougies d'allumage Bosch – Pionnier des bougies d'allumage depuis plus de 111 ans

it

La scintilla che scocca sempre: candele di accensione di Bosch – il pioniere per candele di accensione da più di 111 anni

es

La chispa que nunca falla: bujías de encendido BOSCH – Pionero en bujías de encendido desde hace más de 111 años

pt

A fásca que nunca falha: velas de ignição da Bosch – pioneira em velas de ignição há mais de 111 anos

nl

De vonk die altijd overslaat: bougies van Bosch – sinds meer dan 111 jaar pionier in bougies

sv

Gnistan som alltid tändes säkert: tändstift från Bosch – pionjär för tändstift sedan mer än 111 år

cs

Jiskra, která vždy bezpečně zapálí: Zapalovací svíčky Bosch – průkopník v oblasti zapalovacích svíček již více než 111 let

ru

кра, которая всегда надежно зажигает: свечи зажигания Bosch – пионер в области свечей зажигания на протяжении более 111 лет

pt

Distância entre electrodos prescrita

Se não existirem velas de ignição com a distância entre electrodos prescrita disponíveis, a distância entre electrodos tem de ser reajustada. Para tal, aconselhamos a utilização do calibre de velas de ignição da Bosch.

nl

Voorgeschreven elektrodenafstand

Indien geen bougies met de voorgeschreven elektrodenafstand ter beschikking staan, moet de elektroden-afstand worden afgesteld. Wij raden u aan, hiervoor de bougievoelmaat van Bosch te gebruiken.

sv

Föreskrivet elektrodavstånd

Om tändstift med föreskrivet elektrodavstånd inte finns att tillgå, måste elektrodavståndet justeras. För justering rekommenderas Boschs tändstiftstolk.

cs

Předepsaný odstup elektrod

Pokud nejsou zapalovací svíčky s předepsaným odstupem elektrod k dispozici, musí být odstup elektrod nastaven. K tomuto doporučujeme používat měрку zapalovacích svíček Bosch.

ru

Предписываемый зазор между электродами

Если в распоряжении нет свечей зажигания с предписываемым зазором между электродами, то этот зазор необходимо отрегулировать. Для этого мы рекомендуем использовать вечную шуп фирмы Bosch.

**Inhalt Content Contenu Contenuto Contenido
 Conteúdo Inhoud Innehåll Obsah Содержание**

Angebot Proposta	Offer Assortiment	Offre Offert	Offerta Nabídka	Oferta Ассортимент
---------------------	----------------------	-----------------	--------------------	-----------------------



A 2



A 102

Verwendung Utilização	Applications Gebruik	Applications Användning	Impiego Použití	Aplicación Применение
--------------------------	-------------------------	----------------------------	--------------------	--------------------------

< 50 ccm

B2



> 50 ccm

B31



B89



B115



B129



Gegenüber- stellung Comparação	Cross-reference Opzoektabel	Table de correspondance Jämförelse	Comparazione Převod	Equivalencias Сопоставления
--------------------------------------	--------------------------------	--	------------------------	--------------------------------



C 2



Typformelerklärung



Sitzform und Gewinde	A	D	E	F	H	K	L	M
	M 12x1,25	M 18x1,5	M 10x1,0	M 14x1,25	M 14x1,25	M 14x1,25	M 14x1,25	M 18x1,5

Ausführung	B	C	E	G	H
	wasserdicht, für geschirmte Zündleitung Ø 7 mm	wasserdicht, für geschirmte Zündleitung Ø 5 mm	Gleitfunken Zündkerze ohne Masseelektrode	Gleitfunken Zündkerze mit Masseelektrode(n)	Halbgewinde

Wärmezahl	13 12 11 10 9 8 7 6 5 4 3 2 09 08 07 06									
-----------	---	--	--	--	--	--	--	--	--	--

Gewindelänge Funkenlage	A	B	C	H	J	K	S	T	U	
	12,7		12,7		19		26,5		26,5	
	*11,2		*11,2		17,5		25		25	

Masseelektroden-Ausführung	D	T	Q
----------------------------	---	---	---

Mittелеlektroden-Werkstoff	C	E	P	S	I
	Chrom-Nickel mit Kupferkern	Nickel-Yttrium mit Kupferkern	Platin	Silber	Iridium

Ausführungsart	R	S	T	U	V
	Abbrandwiderstand	0,7	0,8	1,0	1,3
	W	X	Y	Z	
	0,9	1,1	1,5	2,0	

* Die Gewindelänge für Zündkerzen mit Sitzform D und Funkenlage A oder B beträgt 10,9 mm.

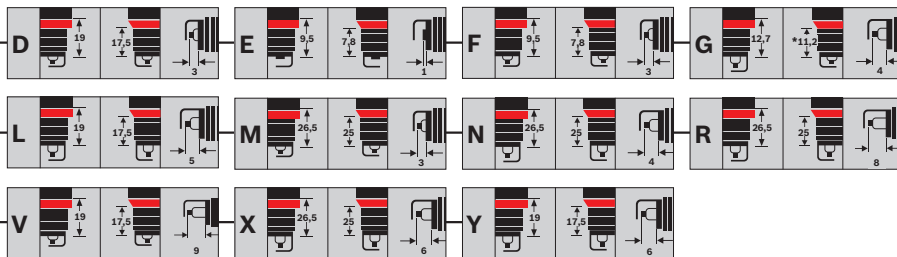
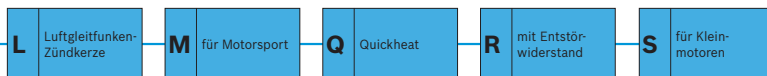
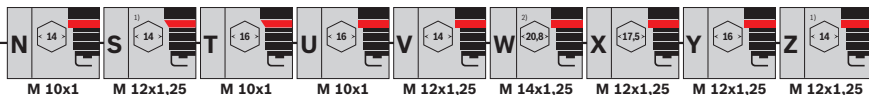

0 Abweichungen von Grundausführung

1 P0-Ausführung mit Ni-Masseelektrode

2 Zweistoff-Masseelektrode

3 Gewinde in Sonderlänge

4 Verlängerter Isolatorfuß

9 Sonderausführung

	Mittelektrode mit aufgeschweißtem Edelmetallplättchen Durchmesser 0,8 oder 1,1 mm möglich	Mittelektrode mit aufgeschweißtem Edelmetallstift mit Durchmesser 0,6 oder 0,8 mm möglich	Masseelektrode Einstoff Nickel-Yttrium	Masseelektrode Zweistoff Nickel-Yttrium	Masseelektrode Einstoff Nickel-Yttrium mit laserlegierter Edelmetalleinlage	Masseelektrode Zweistoff Nickel-Yttrium mit laserlegierter Edelmetalleinlage	Masseelektrode Einstoff Nickel-Yttrium mit lasergeschweißtem Edelmetallstift mit Durchmesser 0,6 mm
10	●	—	●	—	—	—	—
15	●	—	●	—	—	—	—
22	●	—	—	—	●	—	—
222	●	—	—	—	—	●	—
23	—	●	—	—	●	—	—
232	—	●	—	—	—	●	—
30	—	●	●	—	—	—	—
302	—	●	—	●	—	—	—
33	—	●	—	—	●	—	—
332	—	●	—	—	—	●	—
35	—	●	—	—	—	—	●

¹⁾ Doppelsechskant ²⁾ Schlüsselweite 19,0 mm bei Kleinmotoren-Ausführung WS

Zündkerzen-Funkentechnik



Dachelektrode – Mittlelektrode (Abb. a).

Seitenelektrode – Mittlelektrode (Abb. b).



Profilierte Masseelektrode – Mittlelektrode (Abb. c).

Zündkerzen mit Luftfunken-Technik

Der Zündfunke durchschlägt auf direktem Weg zwischen Mittlelektrode und Masseelektrode das Luft-Kraftstoff-Gemisch, das sich zwischen den Elektroden befindet (Abb. a, b, c).

Die Vorteile:

- ▶ Hohe Zündsicherheit über die gesamte Nutzungsdauer
- ▶ Gutes Kaltstartverhalten
- ▶ Geringer Zündspannungsbedarf

Die innenliegenden, zusätzlichen scharfen Kanten, die durch das Profil der Masseelektrode gebildet werden, sorgen in Verbindung mit dem vergrößerten Raum zwischen den Elektroden für eine leichtere, noch effektivere Übertragung der Wärmeenergie des Funkens in das Kraftstoff-Luft-Gemisch (Abb. c).

Die Vorteile:

- ▶ Hohe Zündsicherheit durch schnelleres Überspringen des Zündfunkens und Entflammen des Gemisches
- ▶ Zusätzliche Kaltstartsicherheit auch bei niedriger Bordspannung
- ▶ Bessere Verbrennung zum Schutz des Motors und insbesondere des Katalysators
- ▶ Zusätzlich verringerter Kraftstoffverbrauch durch Vermeiden von Fehlzündungen



Seitenelektrode – Isolatoroberfläche – Mittelelektrode

Zündkerzen mit Gleitfunken-Technik

Die Masseelektroden sind konstruktiv so angebracht, dass sich ausschließlich die besonders langen und kräftigen Luftgleitfunken ausbilden können (Abb. d).

Die Vorteile:

- ▶ Erhöhte Zündsicherheit über gesamte Nutzungsdauer
- ▶ Optimaler Schutz des Katalysators
- ▶ Besonders niedriger Zündspannungsbedarf
- ▶ Selbstreinigende Wirkung bei Verrußung
- ▶ Erhöhte Nutzungsdauer durch Anbringung mehrerer Masseelektroden



Seitenelektrode – Mittelelektrode oder
Seitenelektrode – Isolatoroberfläche – Mittelelektrode

Zündkerzen mit Luftgleitfunken-Technik

Der Zündfunke wählt den für die sichere Zündung besten Weg von der Mittelelektrode zur Masseelektrode, entweder als Luftfunke oder als Luftgleitfunke. Der Luftfunke springt bei der Zündung auf direktem Weg von der Mittelelektrode zur Masseelektrode. Der Luftgleitfunke gleitet über vorhandene Ladungsträger auf der Isolatorfußspitze und springt als Luftfunke zur Masseelektrode (Abb. e).

Die Vorteile:

- ▶ Erhöhte Zündsicherheit über gesamte Nutzungsdauer
- ▶ Verbessertes Kaltstartverhalten
- ▶ Geringer Zündspannungsbedarf
- ▶ Selbstreinigende Wirkung bei Verrußung
- ▶ Optimaler Schutz des Katalysators
- ▶ Die Anordnung mehrerer Masseelektroden erhöht die Nutzungsdauer

Zündkerzengesichter



1 + 2 Normal

Isolatorfuß von grauweißer-graugelber bis rehbrauner Farbe. Motor ist in Ordnung. Wärmewert richtig gewählt. Gemischeinstellung und ZündEinstellung sind einwandfrei, keine Zündaussetzer, Kaltstarteinrichtung funktioniert. Keine Rückstände von bleihaltigen Kraftstoffzusätzen oder Legierungsbestandteilen vom Motoröl. Keine thermische Überlastung.

3 + 4 Verrußt

Isolatorfuß, Elektroden und Zündkerzengehäuse mit samtartigem, stumpfschwarzem Ruß bedeckt.

Ursache: Fehlerhafte Gemischeinstellung (Vergaser, Einspritzung): Gemisch zu fett, Luftfilter stark verschmutzt, Startautomatik nicht in Ordnung oder Starterzug (Choke) zu lange gezogen, überwiegend Kurzstreckenverkehr, Zündkerze zu kalt, Wärmewert-Kennzahl zu niedrig.

Auswirkung: Zündaussetzer, schlechtes Kaltstartverhalten.

Abhilfe: Gemisch und Starteinrichtung richtig einstellen, Luftfilter prüfen.

5 + 6 Verölt

Isolatorfuß, Elektroden und Zündkerzengehäuse mit ölglänzendem Ruß oder Ölkohle bedeckt.

Ursache: Zu viel Öl im Verbrennungsraum. Ölstand zu hoch, stark verschlissene Kolbenringe, Zylinder und Ventileführungen. Bei 2-Takt-Ottomotoren zu viel Öl im Gemisch.

Auswirkung: Zündaussetzer, schlechtes Startverhalten.

Abhilfe: Motor überholen, richtiges Kraftstoff-Öl-Gemisch, neue Zündkerzen.



7 Ferrocen

Isolatorfuß, Elektroden und teilweise das Zündkerzengehäuse mit orangeroten, festhaftenden Ablagerungen bedeckt.

Ursache: Eisenhaltige Kraftstoffadditive. Die Ablagerung entsteht im normalen Betrieb nach wenigen tausend Kilometern.

Auswirkung: Der eisenhaltige Belag ist elektrisch leitend und bewirkt Zündaussetzer.

Abhilfe: Neue Zündkerzen, Reinigung ist zwecklos.

8 Verbleiung

Isolatorfuß weist stellenweise braungelbe Glasur auf, die auch ins Grünliche gehen kann.

Ursache: Bleihaltige Kraftstoffzusätze. Die Glasur entsteht bei hoher Motorbelastung nach längerem Teillastbetrieb.

Auswirkung: Bei höherer Last wird Belag elektrisch leitend und bewirkt Zündaussetzer.

Abhilfe: Neue Zündkerzen, Reinigung ist zwecklos.

9 + 10 Starke Verbleiung

Isolatorfuß weist stellenweise dicke braungelbe Glasur auf, die auch ins Grünliche gehen kann.

Ursache: Bleihaltige Kraftstoffzusätze. Die Glasur entsteht bei hoher Motorbelastung nach längerem Teillastbetrieb.

Auswirkung: Bei höherer Last wird Belag elektrisch leitend und bewirkt Zündaussetzer.

Abhilfe: Neue Zündkerzen, Reinigung ist zwecklos.

11 + 12 Aschebildung

Starker Aschebelag aus Öl- und Kraftstoffzusätzen auf dem Isolatorfuß, im Atmungsraum (Ringspalt) und auf der Masseelektrode. Lockerer bis schlackenähnlicher Aufbau.

Ursache: Legierungsbestandteile insbesondere aus Öl können diese Asche im Brennraum und auf dem Kerzengesicht hinterlassen.

Auswirkung: Kann zu Glühzündungen mit Leistungsverlust und zu Motorschäden führen.

Abhilfe: Motor in Ordnung bringen. Neue Zündkerzen, evtl. anderes Öl verwenden.

Zündkerzengesichter



13



13 Angeschmolzene Mittelelektrode

Mittelelektrode angeschmolzen, blasige schwammartige, erweichte Isolatorfußspitze.

Ursache: Thermische Überlastung aufgrund von Glühzündungen, z. B. durch zu frühe Zündeneinstellung, Verbrennungsrückstände im Brennraum, defekte Ventile, schadhafte Zündverteiler und unzureichende Kraftstoffqualität. Evtl. Wärmewert zu niedrig.

Auswirkung: Zündaussetzer, Leistungsverlust (Motorschaden).

Abhilfe: Motor, Zündung und Gemischaufbereitung überprüfen.
Neue Zündkerzen mit richtigem Wärmewert.

14



14 Abgeschmolzene Mittelelektrode

Mittelelektrode abgeschmolzen, Masselektrode gleichzeitig stark angegriffen.

Ursache: Thermische Überlastung aufgrund von Glühzündungen, z. B. durch zu frühe Zündeneinstellung, Verbrennungsrückstände im Brennraum, defekte Ventile, schadhafte Zündverteiler und unzureichende Kraftstoffqualität.

Auswirkung: Zündaussetzer, Leistungsverlust, evtl. Motorschaden.
Isolatorfußriss durch überhitzte Mittelelektrode möglich.

Abhilfe: Motor, Zündung und Gemischaufbereitung überprüfen.
Neue Zündkerzen.

15



15 Angeschmolzene Mittelelektrode

Blumenkohlfartiges Aussehen der Elektroden. Evtl. Niederschlag von kerzenfremden Materialien.

Ursache: Thermische Überlastung aufgrund von Glühzündungen, z. B. durch zu frühe Zündeneinstellung, Verbrennungsrückstände im Brennraum, defekte Ventile, schadhafte Zündverteiler und unzureichende Kraftstoffqualität.

Auswirkung: Vor Totalausfall (Motorschaden) tritt Leistungsverlust auf.

Abhilfe: Motor, Zündung und Gemischaufbereitung prüfen.
Neue Zündkerzen.



16 Starker Verschleiß der Mittelelektrode

Ursache: Zündkerzen-Wechselintervall nicht beachtet.

Auswirkung: Zündaussetzer, besonders beim Beschleunigen (Zündspannung für großen Elektrodenabstand nicht mehr ausreichend). Schlechtes Startverhalten.

Abhilfe: Neue Zündkerzen.



17 Starker Verschleiß der Masseelektrode

Ursache: Aggressive Kraftstoff- und Ölzusätze. Ungünstige Strömungsverhältnisse im Brennraum, evtl. aufgrund von Ablagerungen, Motorklopfen. Keine thermische Überlastung.

Auswirkung: Zündaussetzer, besonders beim Beschleunigen (Zündspannung für großen Elektrodenabstand nicht mehr ausreichend). Schlechtes Startverhalten.

Abhilfe: Neue Zündkerzen.



18 Isolatorfußbruch

Ursache: Mechanische Beschädigung durch Schlag, Fall oder Druck auf die Mittelelektrode bei unsachgemäßer Handhabung. In Grenzfällen kann durch Ablagerungen zwischen Mittelelektrode und Isolatorfuß und durch Korrosion der Mittelelektrode der Isolatorfuß – besonders bei überlanger Betriebsdauer – gesprengt werden.

Auswirkung: Zündaussetzer, Zündfunke springt an Stellen über, die durch Frischgemisch nicht sicher erreicht werden.

Abhilfe: Neue Zündkerzen.



Bosch-Tipp



Flachdichtsitz

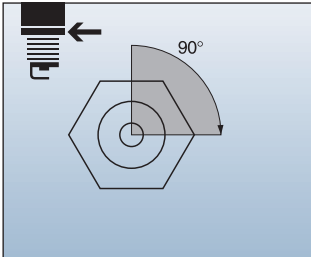

M 10 x1	10...15	10...15
M 12 x1,25	15...25	15...20
M 14 x1,25 <13 mm	20...25	15...20
M 14 x1,25 >13 mm	20...40	20...30
M 18 x1,5	30...45	20...35

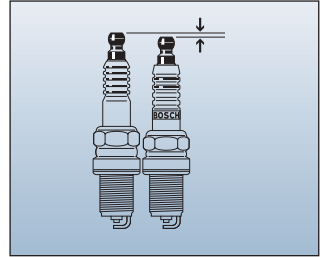
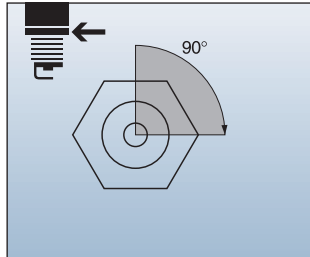

Kegeldichtsitz

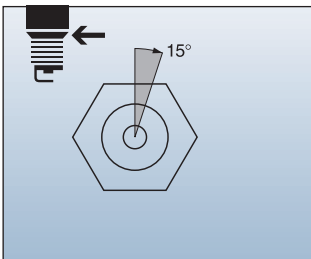

M 14 x1,25	20...40	10...20
M 18 x1,5	30...45	15...23

① in Gusseisen
② in Leichtmetall

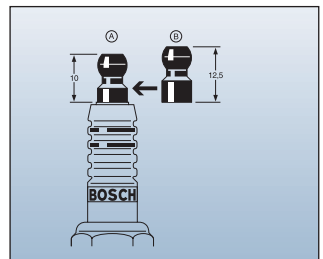
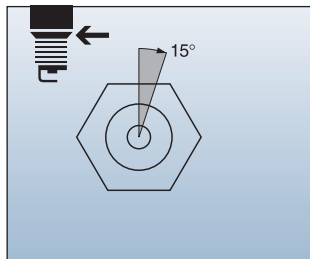

Richtiger Zündkerzeneinbau mit Drehmomentschlüssel:

Anziehdrehmoment (N · m):
10 N · m ≈ 1 kp

Bitte beachten:

Die genannten Anziehdrehmomente gelten für trockene, nicht gefettete und nicht geölte Gewinde und für neue Dichtringe. Bei geschmierem Gewinde sind die angegebenen Anziehdrehmomente um 1/3 zu reduzieren.

Richtiger Zündkerzeneinbau ohne Drehmomentschlüssel:

Bitte beachten:

Zündkerze mit der Hand bis zum Aufsitzen in den Zylinderkopf einschrauben. Zündkerzen mit Flachdichtsitz und neuer Dichtung werden dann mit dem Zündkerzenschlüssel um ca. 90° weitergedreht. Zündkerzen mit Kegeldichtsitz und Zündkerzen mit gebrauchtem Flachdichtring werden dann um ca. 15° weitergedreht. Zündkerzen mit massivem Dichtring dürfen nur mit Drehmomentschlüssel eingebaut werden.

Zündkerzen-Anschlussmuttern

Bitte beachten:

Im Motor können Zündkerzen eingebaut sein, die in ihrer Länge von den Bosch-Zündkerzen abweichen.

1. Alte Zündkerzen herauserschrauben.
2. Mit neuen Bosch-Zündkerzen vergleichen.
3. Falls die ausgetauschte Zündkerze länger ist als die Bosch-Zündkerze, dann die aufgeschraubte Anschlussmutter A durch die beiliegende längere Anschlussmutter B ersetzen.

Zur Beachtung!

Die Zündkerzen-Empfehlungen sind, sofern sie nicht vom Kfz- oder Motorenhersteller stammen, von Bosch festgelegt. Die empfohlenen Zündkerzen gelten für normale Betriebsbedingungen bei Serienmodellen, jedoch nicht für Renn-, Sonder- und Hochleistungsausführungen, es sei denn, solche Modelle sind besonders aufgeführt.

Eine Verwendung anderer als der empfohlenen Wärmewerte kann durch besondere Betriebsbedingungen notwendig werden. Falls Zündkerzen mit dem vorgeschriebenen Elektrodenabstand nicht verfügbar sind, muss der Elektrodenabstand nachgestellt werden. Dazu empfehlen wir die Benutzung der Bosch-Zündkerzenlehre (siehe Seite A 11).

Zubehör

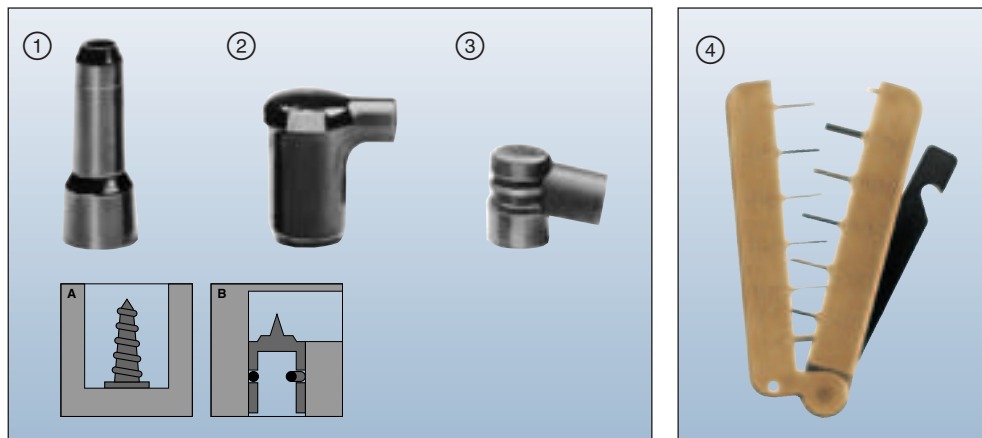

① – ③ Zündkerzenstecker (nicht entstört)

Anschluss Zündkerze	Länge mm	Zündleitung Ø mm	Bemerkungen	Abb.	Bestellnummer
M4	52	7		① A	0 356 002 001
	39/35 ¹⁾	7		② B	0 356 050 001
wasserdicht					
M4	24/30 ¹⁾	5	für Zündkerze kurzer Bauart	③ A (WK..)	0 356 050 009
				③ A (WS..)	0 356 050 010

¹⁾ Zündkerzenseite/Zündleistungsseite

④ Zündkerzenlehre

zum Überprüfen und Nachstellen des Elektrodenabstandes.

Bestellnummer **0 986 600 000**

Isolierpaste (ohne Abb.)

Farbe: weiß

Schmelzpunkt: 320 °C

Eigenschaften: wachsig, geruchlos, Verbesserung der Isoliereigenschaften an sekundärseitigen Verbindungen der Zündanlage, Verhinderung von Kopfüberschlägen an Zündkerzen

Anwendung: Zündkerzenstecker, Entstörstecker, Schutzkappen, Verteilerkappen u. Ä.

EG-Sicherheitsdatenblatt: **1 987 123 010**

45-ml-Tube **1 987 123 010**

Anschlussmutter (ohne Abb.)

Für Zündkerzen-Anschlussgewinde M4. Zinkdruckguss, blank, Packeinheit 25 Stück

Länge 10 mm **1 243 345 023**

Länge 12,5 mm **1 243 345 025**

Flachdichtring (ohne Abb.)

Für Zündkerzen mit

Einschraubgewinde M 14 x 1,25 **1 240 280 028**

Type-code explanatory notes

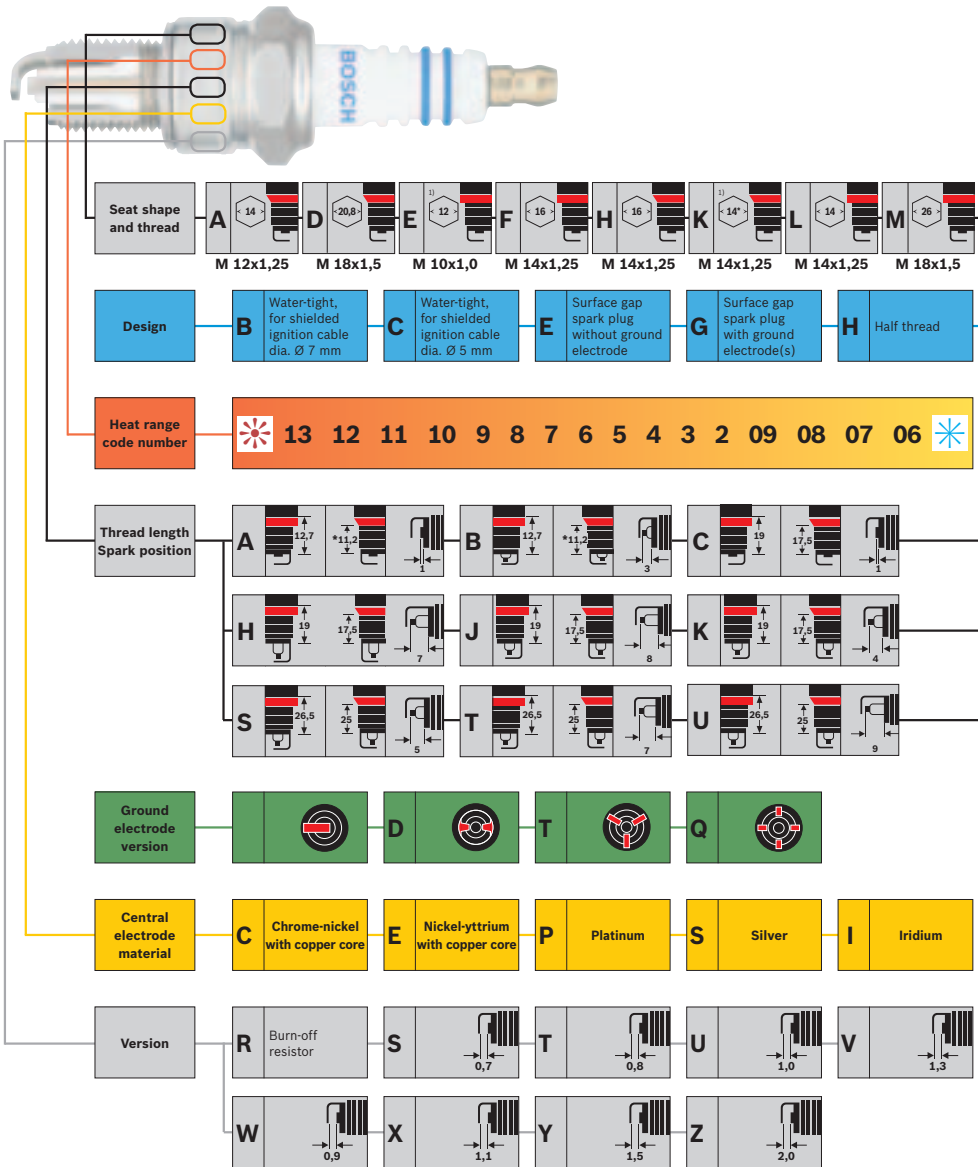

* The thread length for spark plugs with seat shape D and spark position A or B is 10.9 mm.

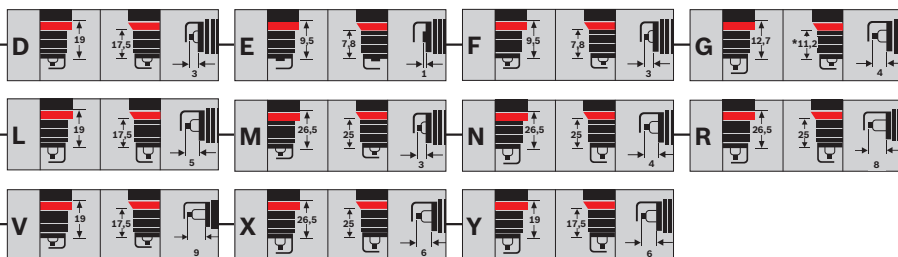
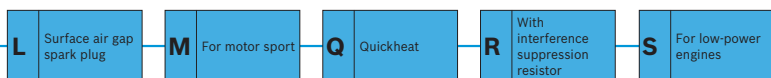
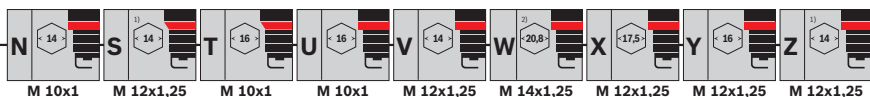

0 Differences from basic design

1 P0 design with Ni ground electrode

2 Binary ground electrode

3 Special length thread

4 Extended insulator nose

9 Special design

	Center electrode with welded-on precious metal wafer Diameter 0.8 or 1.1 mm possible	Center electrode with welded-on precious metal wafer Diameter 0.6 or 0.8 mm possible	Ground electrode Mono nickel-yttrium	Ground electrode Binary nickel-yttrium	Ground electrode Mono nickel-yttrium with laser alloyed precious metal inlay	Ground electrode Binary nickel-yttrium with laser-alloyed precious metal inlay	Ground electrode Mono nickel-yttrium with laser-welded precious metal pin, diameter 0.6 mm
10	●	—	●	—	—	—	—
15	●	—	●	—	—	—	—
22	●	—	—	—	●	—	—
222	●	—	—	—	—	●	—
23	—	●	—	—	●	—	—
232	—	●	—	—	—	●	—
30	—	●	●	—	—	—	—
302	—	●	—	●	—	—	—
33	—	●	—	—	●	—	—
332	—	●	—	—	—	●	—
35	—	●	—	—	—	—	●

¹⁾ Double hexagon ²⁾ Hexagon size 19.0 mm for low-power engine version WS

A14

Spark-plug designs



Top electrode – center electrode (Figs. a).
Side electrode – center electrode (Figs. b).

Spark plugs of air gap design

On a direct path between center electrode and ground electrode, the ignition spark passes through the air/fuel mixture located between the electrodes (Figs. a, b, c).

Advantages:

- ▶ High ignition reliability over entire service life
- ▶ Efficient cold starting
- ▶ Low ignition voltage requirement

Profiled ground electrode – center electrode (Figs. c).

In conjunction with the increased space between the electrodes, the additional sharp interior edges formed by the profile of the ground electrode ensure easier and more effective transmission of the thermal energy of the spark to the fuel/air mixture (Fig. c).

Advantages:

- ▶ High ignition reliability based on faster flashover of the ignition spark and ignition of the mixture
- ▶ Additional cold starting reliability even with low electrical system voltage
- ▶ Improved combustion to protect the engine, and especially the catalytic converter
- ▶ Additionally reduced fuel consumption by avoiding misfires



Side electrode – insulator surface – center electrode

Spark plugs of surface gap design

The design is such that the layout of the ground electrodes only permits the formation of particularly long and powerful surface air gap sparks (Fig. d).

Advantages:

- ▶ Enhanced ignition reliability over entire service life
- ▶ Optimum catalytic converter protection
- ▶ Very low ignition voltage requirement
- ▶ Longer service life through the use of several ground electrodes

Side electrode – center electrode

or side electrode – insulator surface – center electrode

Spark plugs of surface air gap design

The ignition spark selects the best path from the center electrode to the ground electrode, either as by air gap or surface air gap.

The air gap spark jumps directly from the center electrode to the ground electrode at ignition. The surface air gap spark glides over charge carriers on the insulator nose tip and jumps as an air gap spark to the ground electrode (Fig. e).

Advantages:

- ▶ Enhanced ignition reliability over entire service life
- ▶ Improved cold starting
- ▶ Low ignition voltage requirement
- ▶ Self-cleaning effect with soot deposits
- ▶ Optimum catalytic converter protection
- ▶ The multiple ground electrodes arrangement extends service life

Spark-plug designs



1 + 2 Normal

Insulator nose from gray-white/gray-yellow to fawn brown color. Engine is ok. Heat range correctly selected. Mixture setting and ignition timing OK, no misfiring, cold starting device functioning. No residue from fuel additives containing lead or alloying constituents from engine oil. No thermal overload.

3 + 4 Carbon-fouled

Insulator nose, electrodes and spark-plug shell covered with velvet-like dull black soot deposits.

Cause: Incorrect mixture setting (carburetor, injection): Mixture too rich, air cleaner severely fouled, automatic choke not OK or manual choke actuated too long, predominantly short distance driving, spark plug too cold, heat range code number too low.

Effect: Misfiring, poor cold starting performance.

Remedy: Set mixture and starting device correctly, check air cleaner.

5 + 6 Oil-fouled

Insulator nose, electrodes and spark-plug shell covered with shiny soot or carbon deposits.

Cause: Too much oil in combustion chamber. Oil level too high, heavily worn piston rings, cylinders and valve guides. In two-stroke gasoline engines, too much oil in mixture.

Effect: Misfiring, poor starting performance.

Remedy: Overhaul engine, correct fuel/oil mixture, new spark plugs.



7 Ferrocene

Insulator nose, electrodes and part of the spark plug housing coated with red-orange adherent deposits.

Cause: Fuel additive containing iron. The deposits occur after a few thousand kilometers in normal operation.

Effect: The coating containing iron is electrically conductive and causes misfiring.

Remedy: New spark plugs, cleaning has no effect.

8 Lead deposits

In places, brownish yellow glaze on insulator nose which may also have a greenish tinge.

Cause: Fuel additives containing lead. Glaze develops under heavy engine load after lengthy part load operation.

Effect: With heavy loading, coating becomes conductive and causes misfiring.

Remedy: New spark plugs, cleaning has no effect.

9 + 10 Heavy lead deposits

In places, thick brownish yellow glaze on insulator nose which may also have a greenish tinge.

Cause: Fuel additives containing lead. Glaze develops under heavy engine load after lengthy part load operation.

Effect: With heavy loading, coating becomes conductive and causes misfiring.

Remedy: New spark plugs, cleaning has no effect.

11 + 12 Ash-fouling

Thick ash coating from oil and fuel additives on insulator nose, in scavenging area (annular orifice) and on ground electrode. Loose to cinder-like structure.

Cause: Alloying constituents, particularly from oil, may deposit such ash in the combustion chamber and on the spark-plug face.

Effect: Can lead to auto-ignition with loss of power and engine damage.

Remedy: Repair engine. New spark plugs, possibly use different oil.

Spark-plug designs



13



13 Partially melted center electrode

Center electrode partially melted, blistered, spongy, soft insulator nose tip.

Cause: Thermal overload due to auto-ignition, e.g. excessively advanced ignition timing, combustion residue in combustion chamber, defective valves, defective ignition distributor and poor fuel grade. Heat range possibly too low.

Effect: Misfiring, loss of power (engine damage).

Remedy: Check engine, ignition and mixture formation. New spark plugs with correct heat range.

14



14 Melted center electrode

Center electrode melted, ground electrode also severely corroded.

Cause: Thermal overload due to auto-ignition, e.g. excessively advanced ignition timing, combustion residue in combustion chamber, defective valves, defective ignition distributor and poor fuel grade.

Effect: Misfiring, loss of power, possibly engine damage. Overheated center electrode may cause insulator nose to crack.

Remedy: Check engine, ignition and mixture formation. New spark plugs.

15



15 Partially melted center electrode

Cauliflower-like appearance of electrodes. Possibly precipitation of material not originating from the spark plug.

Cause: Thermal overload due to auto-ignition, e.g. excessively advanced ignition timing, combustion residues in combustion chamber, defective valves, defective ignition distributor and poor fuel grade.

Effect: Loss of power prior to total failure (engine damage).

Remedy: Check engine, ignition and mixture formation. New spark plugs.



16 Severe center-electrode wear

Cause: Spark-plug replacement interval not complied with.

Effect: Misfiring, particularly during acceleration (ignition voltage no longer sufficient for large electrode gap). Poor starting performance.

Remedy: New spark plugs.



17 Severe ground-electrode wear

Cause: Aggressive fuel and oil additives. Unfavorable flow conditions in combustion chamber, possibly due to deposits, engine knocking. No thermal overload.

Effect: Misfiring, particularly during acceleration (ignition voltage no longer sufficient for large electrode gap). Poor starting performance.

Remedy: New spark plugs.



18 Cracking of insulator nose

Cause: Mechanical damage due to impact, dropping or pressure on the center electrode resulting from incorrect handling. In marginal cases – especially after excessively long use – the insulator nose may crack due to deposits between the center electrode and insulator nose, and due to corrosion of the center electrode.

Effect: Misfiring, sparkover at points not reliably supplied with fresh mixture.

Remedy: New spark plugs.



A20

Bosch tip



Flat seat

	①	②
M 10 x1	10...15	10...15
M 12 x1,25	15...25	15...20
M 14 x1,25 <13 mm	20...25	15...20
M 14 x1,25 >13 mm	20...40	20...30
M 18 x1,5	30...45	20...35

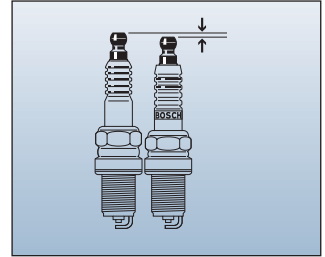
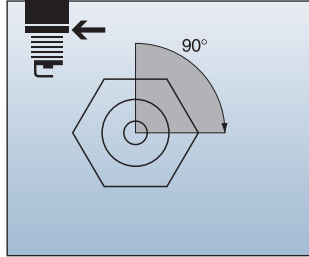

Conical seat

	①	②
M 14 x1,25	20...40	10...20
M 18 x1,5	30...45	15...23

① in cast iron
② in aluminum

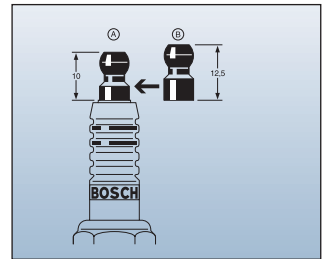
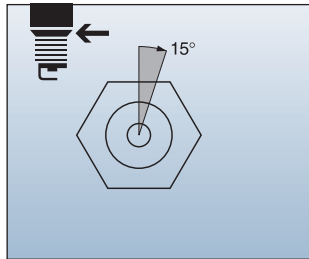

Correct spark plug installation with torque wrench:

Tightening torque (N • m): $10 \text{ N} \cdot \text{m} \approx 1 \text{ kpm}$

Please note:

The tightening torques specified apply to dry, non-greased and non-oiled threads and new gaskets.

For lubricated threads the specified torques should be reduced by 1/3.

Correct spark plug installation without torque wrench:

Please note:

Screw in spark plug by hand until it is seated in the cylinder head. Spark plugs with flat seat and a new seal are then turned about 90° further with the spark plug wrench.

Spark plugs with conical seat and spark plugs with a used flat seal are then turned about 15° further.

Spark plugs with a massive gasket may only be installed using a torque wrench.

Spark plug terminal nuts

Please note:

Engines may be fitted with spark plugs of a different length to Bosch spark plugs.

1. Screw out old spark plugs.
2. Compare to new Bosch spark plugs.
3. If the exchanged spark plug is longer than the Bosch spark plug, replace the screwed-on terminal nut A with the longer terminal nut B provided.

Please note!

The spark-plug recommendations are issued by Bosch, where not originating from the vehicle or engine manufacturer. The recommended spark plugs apply to normal operating conditions for production models, not to racing, special-purpose or high-performance vehicles, unless specifically listed.

Use of heat ranges other than those recommended may be necessary because of special operating conditions. If spark plugs with the specified electrode gap are not available, the electrode gap must be adjusted. For this, we recommend using the Bosch spark plug gage (see page A 21).

Accessories

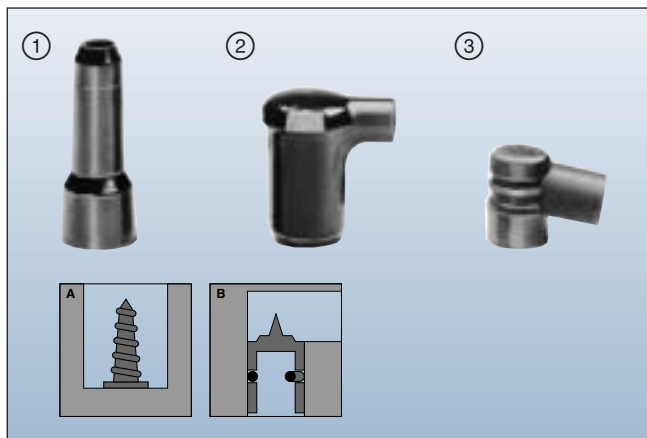

① – ③ Spark-plug connector (not suppressed)

Spark plug connection	Length mm	Ignition cable Ø mm	Comments	Fig.	Part number
M4	52	7		① A	0 356 002 001
	39/35 ¹⁾	7		② B	0 356 050 001
Watertight					
M4	24/30 ¹⁾	5	for short-design spark plug (WK..)	③ A	0 356 050 009
			(WS..)	③ A	0 356 050 010

¹⁾ Spark plug end/ignition cable end

④ Spark-plug-gauge

to check and adjust electrode gap

Part number **0 986 600 000**

Insulating paste (not shown)

Color: White

Melting point: 320°C

Properties: Waxy, odorless, improvement of insulating properties on secondary-side connections of ignition system, prevents head sparkovers on spark plugs

Application: Spark-plug connectors, suppressor connectors, protective caps, distributor caps etc.

EC Safety Data Sheet: **1 987 123 010**

45-ml-tube **1 987 123 010**

Terminal nut (not illustrated)

For M4 spark plug connecting thread.
Cast zinc, polished, package 25 units.

Length 10 mm **1 243 345 023**

Length 12,5 mm **1 243 345 025**

Flat seal (not illustrated)

For spark plugs with

M 14 x 1.25 screw-in thread **1 240 280 028**

Explication de la réf. alphanumérique

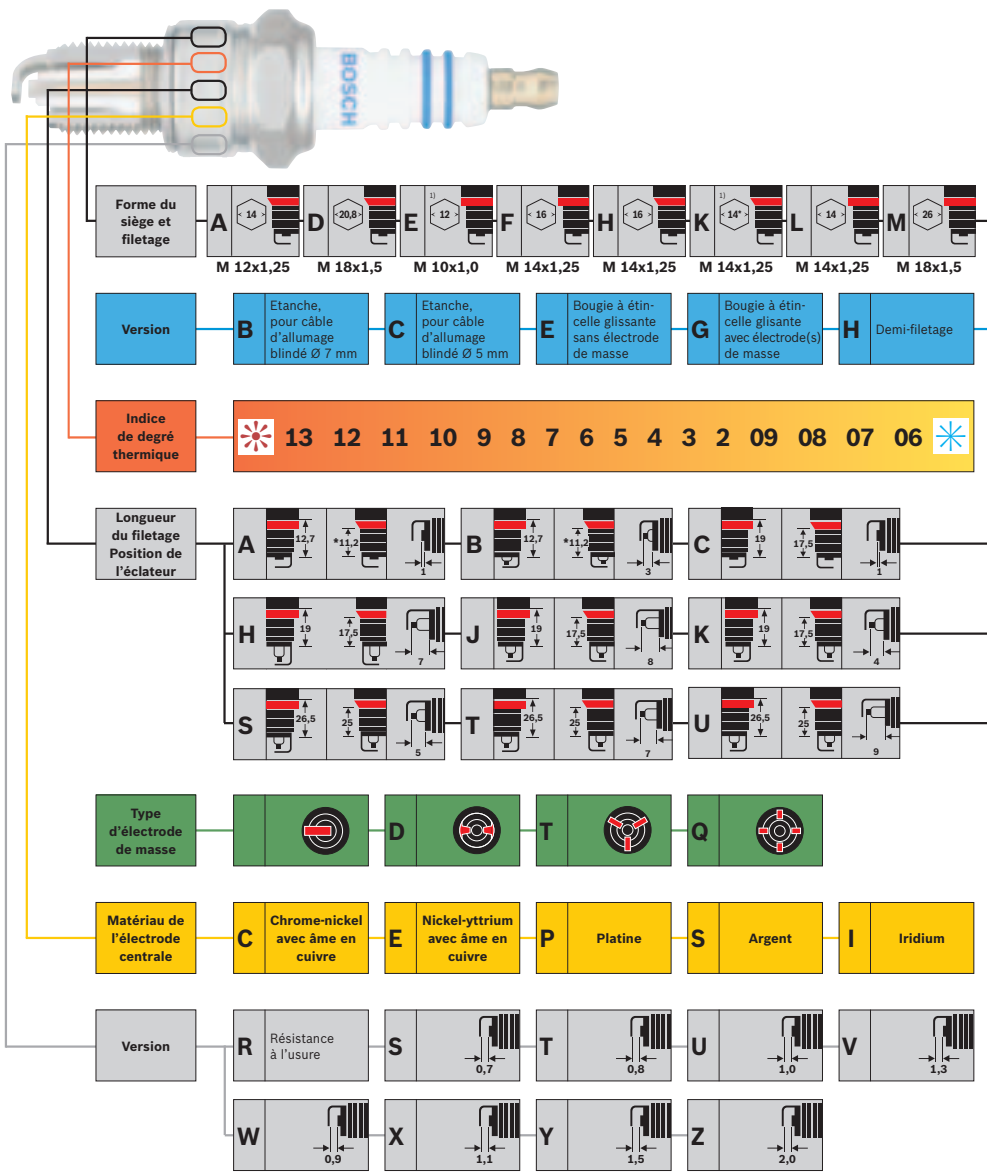

* La longueur du filetage pour les bougies d'allumage de forme de siège D et de position de l'éclateur A ou B est de 10,9 mm.

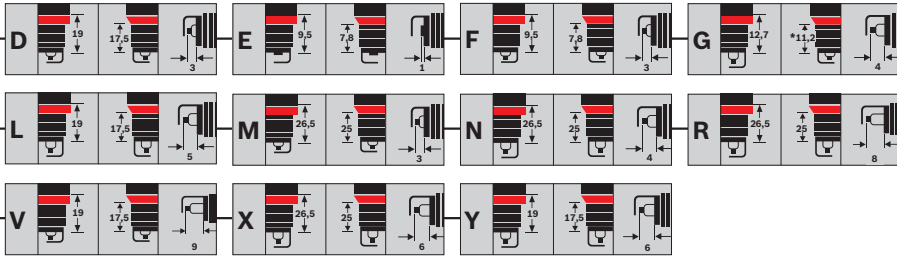
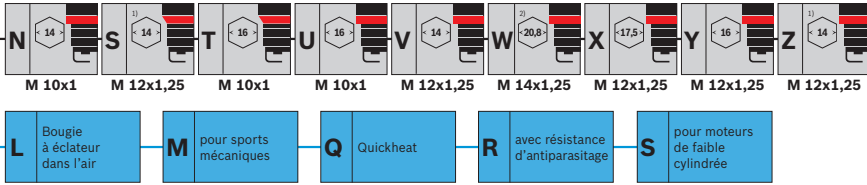

	Electrode centrale avec pastille de métal précieux soudée diamètre possible 0,8 ou 1,1 mm	Electrode centrale avec pastille de métal précieux soudée diamètre possible 0,6 ou 0,8 mm	Electrode de masse en nickel-yttrium	Electrode de masse Alliage nickel-yttrium	Electrode de masse en nickel-yttrium avec noyau en alliage de métal précieux	Electrode de masse Alliage nickel-yttrium avec noyau en alliage de métal précieux	Electrode de masse en nickel-yttrium avec pointe en métal précieux soudée par laser, Ø 0,6 mm
0	Divergences par rapport à la version de base						
1	Version PO avec électrode de masse Ni						
2	Electrode de masse composite						
3	Filetage de longueur spéciale						
4	Bec d'isolateur prolongé						
9	Version spéciale						
10	●	-	●	-	-	-	-
15	●	-	●	-	-	-	-
22	●	-	-	-	●	-	-
222	●	-	-	-	-	●	-
23	-	●	-	-	●	-	-
232	-	●	-	-	-	●	-
30	-	●	●	-	-	-	-
302	-	●	-	●	-	-	-
33	-	●	-	-	●	-	-
332	-	●	-	-	-	●	-
35	-	●	-	-	-	-	●

1) Tête bi-hexagonale 2) Ouverture de clé 19,0 mm pour la version moteurs de faible puissance WS

Technique des éclateurs



Electrode frontale – Electrode centrale (Fig. a).
Electrode latérale – Electrode centrale (Fig. b).

Bougies d'allumage avec éclateur dans l'air

L'étincelle d'allumage traverse et enflamme, par la voie la plus directe entre l'électrode centrale et l'électrode de masse, le mélange air-carburant qui se trouve entre les électrodes (Fig. a, b, c).

Avantages:

- ▶ Grande fiabilité d'allumage pendant toute la durée d'utilisation
- ▶ Démarrage à froid efficace
- ▶ Réduct. de la tension d'allumage nécessaire

Electrode de masse profilée – Electrode centrale (Fig. c).

Les angles vifs complémentaires, orientés vers l'intérieur, résultant du profil de l'électrode de masse, assurent, en association avec l'augmentation de l'écartement entre les électrodes, une transmission plus facile, encore plus efficace, de l'énergie calorifique de l'étincelle au mélange air-carburant. Cette configuration génère un coeur de la flamme plus intense et une combustion totale quelles que soient les conditions de fonctionnement (Fig. c)

Avantages:

- ▶ Haute fiabilité de l'allumage grâce à la rapidité de la propagation de l'étincelle d'allumage et de l'inflammation du mélange
- ▶ Facilité de démarrage à froid accrue même avec une tension du réseau de bord faible
- ▶ Amélioration de la combustion source d'une meilleure protection du moteur et en particulier du catalyseur
- ▶ Réduction supplémentaire de la consommation de carburant en raison de l'élimination des ratés d'allumage



Electrode latérale – Tête d'isolateur – Electrode centrale

Bougies d'allumage avec éclateur à étincelle glissante

Les électrodes de masse sont conçues et disposées de manière à générer uniquement des étincelles glissantes très longues et puissantes (Fig. d).

Avantages:

- ▶ Fiabilité d'allumage accrue pendant toute la durée d'utilisation
- ▶ Protection optimale du catalyseur
- ▶ Tension d'allumage nécessaire très faible
- ▶ Effet d'auto-nettoyage en cas de calaminage
- ▶ Durabilité accrue grâce à la présence de plusieurs électrodes de masse



Electrode latérale – Electrode centrale ou électrode latérale – Tête d'isolateur – Electrode centrale

Bougies d'allumage avec éclateur à glissement dans l'air

Les bougies d'allumage avec éclateur à glissement dans l'air sont de plus en plus utilisées en première monte. L'étincelle d'allumage choisit le meilleur chemin de l'électrode centrale vers l'électrode de masse, pour assurer une inflammation sûre du mélange, soit comme étincelle dans l'air, soit comme étincelle à glissement dans l'air. A l'allumage, l'étincelle dans l'air saute directement de l'électrode centrale à l'électrode de masse. L'étincelle à glissement dans l'air utilise les porteurs de charge pour glisser sur le bec de l'isolateur puis éclater dans l'air sur l'électrode de masse. Les dépôts de particules de suie sont ainsi brûlés et les dérivations sont supprimées (Fig. e).

Avantages:

- ▶ Sécurité d'allumage accrue pendant toute la durée d'utilisation
- ▶ Meilleur démarrage à froid
- ▶ Réduction de la tension d'allumage nécessaire
- ▶ Effet d'auto-nettoyage en cas de calaminage
- ▶ Protection optimale du catalyseur
- ▶ La disposition de plusieurs électrodes de masse procure une durée d'utilisation prolongée

Aspects des bougies d'allumage



1 + 2 Normale

Bec d'isolateur gris-blanc/gris-jaune à fauve. Le moteur est en ordre. Le degré thermique est correctement choisi.

Le mélange et l'allumage sont réglés correctement, pas de ratés d'allumage, le dispositif de démarrage à froid fonctionne bien. Absence de résidus provenant des additifs plombés du carburant ou de composants alliés aux huiles-moteur. Pas de surcharge thermique.

3 + 4 Calamine

Le bec d'isolateur, les électrodes et le culot de bougie sont recouverts de suie noirâtre, d'aspect velouté.

Cause : Mauvais réglage du mélange (carburateur, injection) : mélange trop riche, filtre à air très encrassé, le starter automatique fonctionne mal ou le starter (choke) reste trop longtemps en action, trajets fréquents sur courtes distances, bougie trop « froide », indice de degré thermique trop faible.

Effet : Ratés d'allumage, mauvais démarrage à froid.

Remède : Effectuer un réglage correct du mélange et du dispositif de démarrage, contrôler le filtre à air.

5 + 6 Dépôt huileux

Le bec d'isolateur, les électrodes et le culot de bougie sont recouverts de suie grasse brillante d'huile ou de calamine.

Cause : Trop d'huile dans la chambre de combustion. Niveau d'huile trop haut, forte usure des segments de piston, des cylindres et des guides de soupapes. Dans le cas des moteurs à essence 2 temps, le mélange contient trop d'huile.

Effet : Ratés d'allumage, mauvais comportement du moteur au démarrage.

Remède : Réviser le moteur, utiliser le bon mélange carburant-huile, monter des bougies neuves.



7 Ferrocène

Le bec d'isolateur, les électrodes et en partie le culot de bougie sont recouverts de dépôts adhérents, de couleur rouge-orange.

Cause: Le carburant contient des additifs à base de fer. Le dépôt se forme durant le fonctionnement normal, après quelques milliers de kilomètres.

Effet: Le dépôt ferreux est conducteur et provoque des ratés d'allumage.

Remède: Monter des bougies neuves, le nettoyage des bougies est sans effet.

8 Dépôt plombeux

Le bec d'isolateur présente par endroits une glaçure brun-jaune pouvant aussi tirer sur le vert.

Cause : Le carburant contient des additifs à base de plomb. La glaçure se forme lorsque le moteur est très sollicité, après un fonctionnement prolongé à charge partielle.

Effet : Lorsque la charge augmente, le dépôt devient conducteur et provoque des ratés d'allumage.

Remède : Monter des bougies neuves, le nettoyage des bougies est sans effet.

9 + 10 Dépôt plombeux important

Le bec d'isolateur présente par endroits une épaisse glaçure brun-jaune pouvant aussi tirer sur le vert.

Cause : Le carburant contient des additifs à base de plomb. La glaçure se forme lorsque le moteur est très sollicité, après un fonctionnement prolongé à charge partielle.

Effet : Lorsque la charge augmente, le dépôt devient conducteur et provoque des ratés d'allumage.

Remède : Monter des bougies neuves, le nettoyage des bougies est sans effet.

11 + 12 Formation de cendres

Épais dépôt de cendres généré par les additifs de l'huile et du carburant sur le bec d'isolateur, dans la chambre de respiration (fente annulaire) et sur l'électrode de masse. Consistance des cendres de type poudre ou croûte.

Cause : Les composants alliés, lubrifiants en particulier, peuvent déposer ces cendres dans la chambre de combustion et sur les électrodes de la bougie.

Effet : Eventualité d'auto-allumage et d'une perte de puissance pouvant entraîner une détérioration du moteur.

Remède : Remise en état du moteur. Monter des bougies d'allumage neuves, utiliser éventuellement une autre huile.

Aspects des bougies d'allumage



13



14



15



13 Fusion partielle de l'électrode centrale

Electrode centrale partiellement fondue, bec d'isolateur ramolli et recouvert de boursoufflures spongieuses.

Cause : Surcharge thermique due à l'auto-allumage résultant par ex. d'une trop grande avance à l'allumage, de la présence de résidus dans la chambre de combustion, d'un mauvais fonctionnement des soupapes, d'un mauvais fonctionnement de l'allumeur et de la mauvaise qualité du carburant. Le degré thermique de la bougie est peut-être trop faible.

Effet : Ratés d'allumage, perte de puissance (détérioration du moteur).

Remède : Vérifier le moteur, l'allumage et la préparation du mélange. Monter des bougies neuves du bon degré thermique.

14 Fusion complète de l'électrode centrale

L'électrode centrale est complètement fondue, l'électrode de masse est fortement attaquée.

Cause : Surcharge thermique due à l'auto-allumage résultant par ex. d'une trop grande avance à l'allumage, de la présence de résidus dans la chambre de combustion, d'un mauvais fonctionnement des soupapes, d'un mauvais fonctionnement de l'allumeur et de la mauvaise qualité du carburant.

Effet : Ratés d'allumage, perte de puissance, détérioration possible du moteur. La surchauffe de l'électrode centrale peut provoquer une fissure du bec d'isolateur.

Remède : Vérifier le moteur, l'allumage et la préparation du mélange. Monter des bougies neuves.

15 Fusion partielle de l'électrode centrale

Les électrodes ont l'aspect d'un chou-fleur. Précipité éventuel de matières étrangères aux bougies.

Cause : Surcharge thermique due à l'auto-allumage résultant par ex. d'une trop grande avance à l'allumage, de la présence de résidus dans la chambre de combustion, d'un mauvais fonctionnement des soupapes, d'un mauvais fonctionnement de l'allumeur et de la mauvaise qualité du carburant.

Effet : Une perte de puissance se manifeste avant la défaillance totale (détérioration du moteur).

Remède : Vérifier le moteur, l'allumage et la préparation du mélange. Monter des bougies neuves.



16 Forte usure de l'électrode centrale

Cause : Les intervalles de remplacement des bougies d'allumage n'ont pas été respectés.

Effet : Ratés d'allumage, surtout aux accélérations (écartement des électrodes trop important pour la tension d'allumage disponible). Mauvais comportement au démarrage.

Remède : Monter des bougies neuves.



17 Forte usure de l'électrode de masse

Cause : Le carburant et l'huile contiennent des additifs agressifs. Influences défavorables sur le brassage dans la chambre de combustion, éventuellement provoquées par des dépôts, cliquetis du moteur. Pas de surcharge thermique.

Effet : Ratés d'allumage, surtout aux accélérations (écartement des électrodes trop important pour la tension d'allumage disponible). Mauvais comportement au démarrage.

Remède : Monter des bougies neuves.



18 Rupture du bec d'isolateur

Cause : Détérioration mécanique due à un choc, une chute ou une pression exercée sur l'électrode centrale lors d'une manipulation incorrecte. Dans les cas extrêmes, les dépôts présents entre l'électrode centrale et le bec d'isolateur et la corrosion de l'électrode centrale peuvent provoquer l'éclatement du bec d'isolateur, notamment dans le cas d'une durée d'utilisation excessive.

Effet : Ratés d'allumage, l'étincelle se propage en des points que le mélange air-carburant n'atteint pas.

Remède : Monter des bougies neuves.



A30

Conseil Bosch



Siège d'étanchéité plat



① ②

M 10 x1	10...15	10...15
M 12 x1,25	15...25	15...20
M 14 x1,25 <13 mm	20...25	15...20
M 14 x1,25 >13 mm	20...40	20...30
M 18 x1,5	30...45	20...35

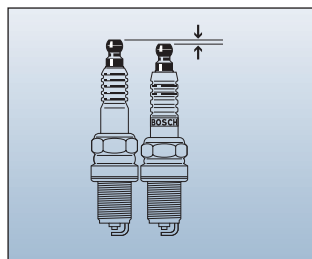
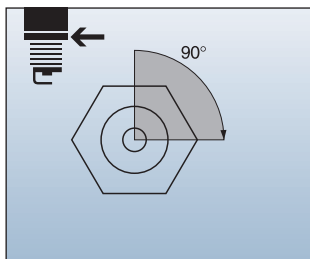

Siège d'étanchéité conique



① ②

M 14 x1,25	20...40	10...20
M 18 x1,5	30...45	15...23

① dans la fonte
② dans l'alliage léger

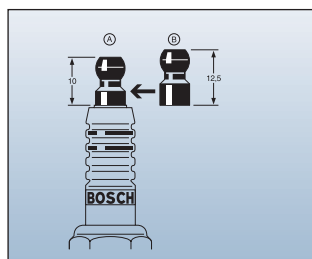
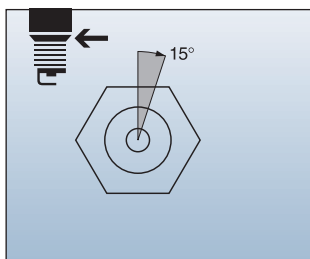

Montage correct de la bougie d'allumage avec une clé dynamométrique:

Couple de serrage (N • m): 10 N • m = 1 kpm

Attention:

Les couples de serrage indiqués sont valables pour des filetages secs, non graissés et non huilés et pour des joints neufs.

Dans le cas d'un filetage lubrifié, réduire les couples de serrage indiqués d'1/3.

Montage correct de la bougie sans clé dynamométrique:

Attention:

Visser la bougie à la main jusqu'à ce qu'elle soit en contact avec la culasse. Tourner ensuite les bougies avec un siège plat et un joint neuf d'env. 90° supplémentaires à l'aide de la clé à bougie. Tourner ensuite les bougies avec un siège conique et les bougies avec un joint plat usagé d'env. 15° degrés supplémentaires.

Les bougies d'allumage avec un joint massif ne doivent être montées qu'avec une clé dynamométrique.

Embouts de connexion des bougies

Attention:

Les bougies montées sur le moteur peuvent avoir une longueur différente de celle des bougies Bosch.

1. Dévisser les anciennes bougies.
2. Les comparer aux bougies Bosch neuves.
3. Si la bougie à remplacer est plus longue que la bougie Bosch, remplacer l'embout vissé A par l'embout de connexion B plus long joint.

Attention!

Si elles ne proviennent pas du constructeur de véhicules ou de moteurs, les recommandations en matière de bougies d'allumage sont fixées par Bosch. Les bougies d'allumage recommandées sont valables dans des conditions de fonctionnement normales sur des modèles de série mais ne conviennent pas pour les versions de course, spéciales et hautes performances, sauf exécution spéciale de ces modèles.

Des conditions de fonctionnement particulières peuvent rendre nécessaire l'utilisation de degrés thermiques autres que ceux recommandés. Si les bougies présentant l'écartement des électrodes prescrit ne sont pas disponibles, l'écartement doit être rajusté. Nous recommandons d'utiliser pour ce faire la jauge pour bougies d'allumage Bosch (voir page A 31).

Accessoires

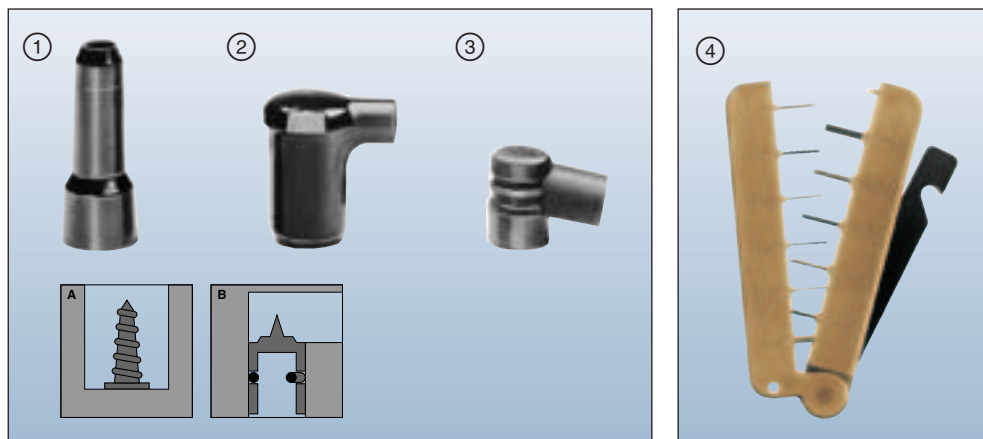

① – ③ Embout de bougie (non antiparasité)

Connexion bougie	Longueur mm	Câble d'allumage Ø mm	Observations	Fig.	Référence
M4	52	7		① A	0 356 002 001
	39/35 ¹⁾	7		② B	0 356 050 001
étanche					
M4	24/30 ¹⁾	5	pour bougie d'allumage (WK..)	③ A	0 356 050 009
			de type court (WS..)	③ A	0 356 050 010

¹⁾ Côté bougie/côté câble

④ Jauge pour bougies d'allumage

permettant de vérifier et de rajuster l'écartement des électrodes

Référence **0 986 600 000**

Graisse isolante (non représentée)

Couleur: blanche

Point de fusion: 320 °C

Propriétés: type cire, inodore, améliore les caractéristiques d'isolation des connexions secondaires de l'installation d'allumage, prévient la propagation de l'étincelle au moment de l'allumage

Application: embouts de bougies, connecteurs antiparasites, capuchons de protection, têtes d'allumeur, etc.

Fiche de sécurité CE: **1 987 123 010**

Tube de 45 ml **1 987 123 010**

Embout de connexion (non représenté)

Pour filetage de raccordement de bougie M4. Zinc moulé sous pression, nu, conditionnement 25 unités

Longueur 10 mm **1 243 345 023**

Longueur 12,5 mm **1 243 345 025**

Joint plat (non représenté)

Pour bougies avec filetage

M 14 x 1,25 **1 240 280 028**

Spiegazione della sigla



Forma della sede e filettatura	A 14	D 20,8	E 12	F 16	H 16	K 14*	L 14	M 26
	M 12x1,25	M 18x1,5	M 10x1,0	M 14x1,25	M 14x1,25	M 14x1,25	M 14x1,25	M 18x1,5

Esecuzione	B A tenuta d'acqua, per cavo d'accensione schermato Ø 7 mm	C A tenuta d'acqua, per cavo d'accensione schermato Ø 5 mm	E Candela d'accensione a scarica superficiale senza elettrodo di massa	G Candela d'accensione a scarica superficiale con elettrodo/i di massa	H Semifilettatura
-------------------	---	---	---	---	--------------------------

Sigla grado termico	13 12 11 10 9 8 7 6 5 4 3 2 09 08 07 06									
----------------------------	---	--	--	--	--	--	--	--	--	--

Lunghezza filettatura, posizione scintilla	A	B	C
	H	J	K
	S	T	U

Esecuzione elettrodi di massa	D	T	Q
--------------------------------------	----------	----------	----------

Materiale elettrodo centrale	C Cromo-nichel con anima in rame	E Nichel-Yttrium con anima in rame	P Platino	S Argento	I Iridium
-------------------------------------	---	---	------------------	------------------	------------------

Tipo di esecuzione	R	S	T	U	V
	W	X	Y	Z	

* La lunghezza della filettatura per candele d'accensione con la forma della sede D e posizione scintilla A o B è di 10,9 mm.

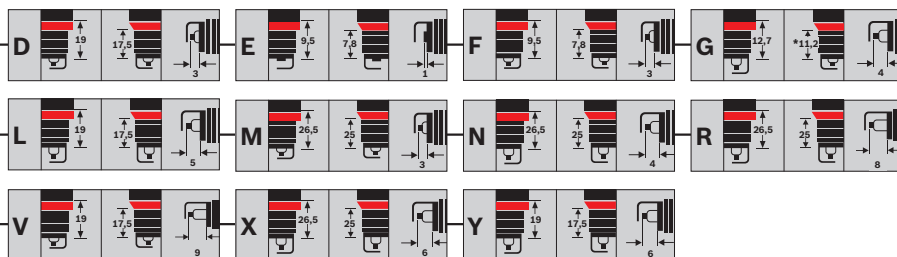
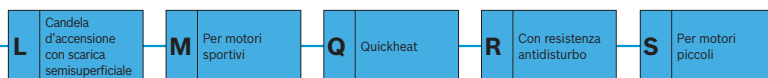
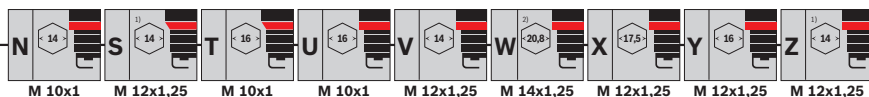

0 Differenze rispetto all'esecuzione di base

- 1 Esecuzione P0 con elettrodo di massa al Ni
- 2 Elettrodo di massa con anima in altro metallo
- 3 Filettatura con lunghezza speciale
- 4 Piede isolatore prolungato
- 9 Esecuzione speciale

	Elettrodo centrale con riporto piano in metallo prezioso Diametro da 0,8 o 1,1 mm	Elettrodo centrale con riporto piano in metallo prezioso Diametro da 0,6 o 0,8 mm	Elettrodo di massa monocomponente al Nichel-Yttrium	Elettrodo di massa bicomponente al Nichel-Yttrium	Elettrodo di massa monocomponente al Nichel-Yttrium inserito in metallo prezioso	Elettrodo di massa bicomponente al Nichel-Yttrium inserito in metallo prezioso	Elettrodo di massa monocomponente al Nichel-Yttrium con spina di metallo prezioso Ø 0,6 mm applicata tramite saldatura al laser
10	●	-	●	-	-	-	-
15	●	-	●	-	-	-	-
22	●	-	-	-	●	-	-
222	●	-	-	-	-	●	-
23	-	●	-	-	●	-	-
232	-	●	-	-	-	●	-
30	-	●	●	-	-	-	-
302	-	●	-	●	-	-	-
33	-	●	-	-	●	-	-
332	-	●	-	-	-	●	-
35	-	●	-	-	-	-	●

¹⁾ Dodecagono ²⁾ Apertura chiave di 19,0 mm per motori piccoli della versione WS

Tecnica della scintilla d'accensione



Elettrodo a tetto – elettrodo centrale (fig. a).
Elettrodo laterale – elettrodo centrale (fig. b).



Elettrodo di massa profilato – elettrodo centrale (fig. c).

Candele d'accensione con scarica in aria

La scintilla d'accensione attraversa direttamente, tra l'elettrodo centrale e l'elettrodo di massa, la miscela aria-carburante che si trova tra gli elettrodi (fig. a, b, c).

Vantaggi:

- ▶ Elevata sicurezza d'accensione per tutta la durata utile
- ▶ Buone prestazioni all'avviamento a freddo
- ▶ Fabbisogno scarso di tensione d'accensione

Gli affilati bordi interni supplementari, formati dal profilo dell'elettrodo di massa, garantiscono, in combinazione allo spazio aumentato tra gli elettrodi, una trasmissione ancora più agevole ed efficace dell'energia termica della scintilla alla miscela carburante-aria (fig. c).

Advantages:

- ▶ Maggiore affidabilità di accensione grazie al salto della scintilla e all'accensione della miscela più rapidi
- ▶ Avviamento a freddo ancora più sicuro, anche in presenza di una bassa tensione di bordo
- ▶ Migliore combustione a protezione del motore ed in particolare del catalizzatore
- ▶ Consumo di carburante ancora più ridotto grazie all'assenza di mancate accensioni



Elettrodo laterale – superficie isolatore – elettrodo centrale

Candele d'accensione a scarica superficiale

Gli elettrodi di massa sono disposti in modo da consentire esclusivamente la formazione di scintille superficiali particolarmente lunghe e forti (fig. d).

Vantaggi:

- ▶ Elevata sicurezza d'accensione per tutta la durata utile
- ▶ Protezione ottimale del catalizzatore
- ▶ Fabbisogno minimo di tensione d'accensione
- ▶ Effetto di autopulitura in caso di residui carboniosi
- ▶ Elevata durata utile grazie all'applicazione di diversi elettrodi di massa

Elettrodo laterale – elettrodo centrale o elettrodo laterale – superficie isolatore – elettrodo centrale

Candele d'accensione a scarica semisuperficiale

La scintilla d'accensione sceglie il percorso migliore per un'accensione sicura, dall'elettrodo centrale all'elettrodo di massa, sotto forma di scintilla in aria oppure scintilla a scarica semisuperficiale. Durante l'accensione, la scintilla in aria scocca direttamente dall'elettrodo centrale all'elettrodo di massa. La scintilla a scarica semisuperficiale striscia sopra conduttori presenti sul piede dell'isolatore e salta quindi come scintilla in aria all'elettrodo di massa (fig. e).

Vantaggi:

- ▶ Elevata sicurezza d'accensione per tutta la durata utile
- ▶ Migliori prestazioni all'avviamento a freddo
- ▶ Fabbisogno scarso di tensione d'accensione
- ▶ Effetto di autopulitura in caso di residui carboniosi
- ▶ Protezione ottimale del catalizzatore
- ▶ La disposizione di più elettrodi di massa consente di ottenere una durata utile più lunga

Aspetto delle candele d'accensione



1 + 2 Normale

Piede dell'isolatore da grigio-bianco a grigio-giallo, fino a marrone rossiccio. Il motore è in ordine. La candela ha il giusto grado termico. La dosatura della miscela e la messa in fase dell'accensione sono perfette, non vi sono mancate accensioni, il dispositivo di avviamento a freddo funziona.

Non vi sono residui di additivi contenenti piombo nel carburante o elementi di additivazione nell'olio motore. Non vi è sovraccarico termico.

3 + 4 Coperta di fuliggine

Piede dell'isolatore, elettrodi e corpo della candela ricoperti di fuliggine vellutata di colore nero opaco.

Cause: dosatura non corretta della miscela (carburatore, iniezione): miscela troppo ricca, filtro aria molto imbrattato, dispositivo automatico di avviamento non a posto oppure starter manuale inserito troppo a lungo, impiego prevalente nel traffico a corto raggio, candela troppo fredda, grado termico troppo basso.

Conseguenze: mancate accensioni, avviamento a freddo difficoltoso.

Rimedi: correggere la registrazione della dosatura della miscela e del dispositivo di avviamento a freddo, controllare il filtro dell'aria.

5 + 6 Imbrattata d'olio

Piede dell'isolatore, elettrodi e corpo della candela ricoperti di fuliggine oleosa o di incrostazioni carboniose.

Cause: trafilamento eccessivo di olio nella camera di combustione. Livello dell'olio troppo alto, fasce elastiche, cilindri e guide valvole molto usurati. Nei motori a benzina a due tempi miscela troppo ricca di olio.

Conseguenze: mancate accensioni, avviamento difficoltoso.

Rimedi: revisionare il motore, correggere la miscela carburante-olio, sostituire le candele d'accensione.



7 Ferrocene

Piede dell'isolatore, elettrodi e in parte il corpo della candela sono ricoperti di depositi di colore rosso-arancione incollati.

Cause: additivi del carburante contenenti ferro. Durante l'esercizio normale, il deposito si forma dopo poche migliaia di chilometri.

Conseguenze: lo strato contenente ferro è conduttivo e provoca mancate accensioni.

Rimedi: sostituire le candele d'accensione, la sola pulizia risulta inutile.

8 Incrostata di piombo

Il piede dell'isolatore in alcuni punti presenta una patina marrone-giallastra che può tendere anche al verde.

Cause: additivi nel carburante contenenti piombo. La formazione della patina viene provocata dalla forte sollecitazione del motore dopo un lungo funzionamento a carico parziale.

Conseguenze: ad un carico maggiore l'incrostazione diventa conduttiva e causa mancate accensioni.

Rimedi: sostituire le candele d'accensione, la sola pulizia risulta inutile.

9 + 10 Fortemente incrostata di piombo

Il piede dell'isolatore presenta in alcuni punti un deposito tipo smalto marrone-giallastro molto spesso che può tendere anche al verde.

Cause: additivi nel carburante contenenti piombo. La formazione della patina viene provocata dalla forte sollecitazione del motore dopo un lungo funzionamento a carico parziale.

Conseguenze: ad un carico maggiore l'incrostazione diventa conduttiva e causa mancate accensioni.

Rimedi: sostituire le candele d'accensione, la sola pulizia risulta inutile.

11 + 12 Formazione di cenere

Forte deposito di cenere causato da additivi nell'olio e nel carburante sul piede dell'isolatore, nello spazio tra isolatore e rivestimento (fessura anulare) e sull'elettrodo di massa. Consistenza da poco compatta a simile a scorie.

Cause: elementi di additivazione, in particolare provenienti dall'olio, possono lasciare questo tipo di cenere nella camera di combustione e sulla candela.

Conseguenze: autoaccensioni con perdita di potenza e danni al motore.

Rimedi: revisionare il motore. Sostituire le candele d'accensione, eventualmente utilizzare un altro tipo di olio.

Aspetto delle candele d'accensione



13



14



15

13 Elettrodo centrale parzialmente fuso

Elettrodo centrale parzialmente fuso, estremità del piede dell'isolatore molle, dall'aspetto spugnoso e con formazione di bolle.

Cause: sovraccarico termico a causa di autoaccensioni, ad es. a causa di una messa in fase dell'accensione con troppo anticipo, residui di combustione nella camera di combustione, valvole difettose, distributore d'accensione non perfettamente funzionante, scadente qualità del carburante. Eventualmente grado termico della candela troppo basso.

Conseguenze: mancate accensioni, perdita di potenza (danni al motore).

Rimedi: controllare il motore, l'accensione e la preparazione della miscela. Candele nuove con il giusto grado termico.

14 Elettrodo centrale completamente fuso

Elettrodo centrale completamente fuso e contemporaneamente elettrodo di massa fortemente corrosivo.

Cause: sovraccarico termico a causa di autoaccensioni, ad es. a causa di una messa in fase dell'accensione con troppo anticipo, residui di combustione nella camera di combustione, valvole difettose, distributore d'accensione non perfettamente funzionante o scadente qualità del carburante.

Conseguenze: mancate accensioni, perdita di potenza, eventualmente danni al motore. È possibile l'incrinatura del piede dell'isolatore a causa del surriscaldamento dell'elettrodo centrale.

Rimedi: controllare il motore, l'accensione e la preparazione della miscela. Sostituire le candele d'accensione.

15 Elettrodo centrale parzialmente fuso

Aspetto degli elettrodi poroso e spugnoso. Eventualmente depositi di materiali estranei alla candela.

Cause: sovraccarico termico a causa di autoaccensioni, ad es. a causa di una messa in fase dell'accensione con troppo anticipo, residui di combustione nella camera di combustione, valvole difettose, distributore d'accensione non perfettamente funzionante o scadente qualità del carburante.

Conseguenze: prima dell'avaria totale (danni al motore) si verifica una perdita di potenza.

Rimedi: controllare il motore, l'accensione e la preparazione della miscela. Sostituire le candele d'accensione.



16 Forte usura dell'elettrodo centrale

Cause: non è stato osservato l'intervallo prescritto per la sostituzione delle candele.

Conseguenze: mancate accensioni, in particolare in accelerazione (tensione d'accensione insufficiente per la distanza grande degli elettrodi). Difficoltà all'avviamento.

Rimedi: Sostituire le candele d'accensione.

17 Forte usura dell'elettrodo di massa

Cause: additivi aggressivi del carburante e dell'olio. Turbolenze sfavorevoli nella camera di combustione, eventualmente a causa di depositi, battito in testa del motore. Non vi è sovraccarico termico.

Conseguenze: mancate accensioni, in particolare in accelerazione (tensione d'accensione insufficiente per la distanza grande degli elettrodi). Difficoltà all'avviamento.

Rimedi: Sostituire le candele d'accensione.

18 Rottura del piede dell'isolatore

Cause: danno meccanico dovuto a colpi, caduta della candela o pressione sull'elettrodo centrale in seguito ad una manipolazione inappropriata. In casi limite il piede dell'isolatore può rompersi a causa di depositi che si formano tra l'elettrodo centrale e il piede dell'isolatore o a causa di corrosione dell'elettrodo centrale, specialmente in casi di lunga durata d'esercizio.

Conseguenze: mancate accensioni, la scintilla d'accensione scocca in punti nei quali la miscela appena entrata nella camera di combustione non arriva in modo affidabile.

Rimedi: Sostituire le candele d'accensione.

Suggerimento Bosch



Sede tenuta piana

M 10 x1	10...15	10...15
M 12 x1,25	15...25	15...20
M 14 x1,25 <13 mm	20...25	15...20
M 14 x1,25 >13 mm	20...40	20...30
M 18 x1,5	30...45	20...35

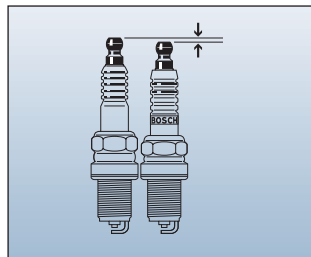
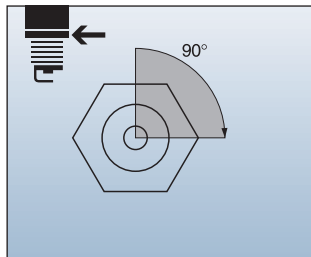

Sede tenuta conica

M 14 x1,25	20...40	10...20
M 18 x1,5	30...45	15...23

① in ghisa
② in lega leggera

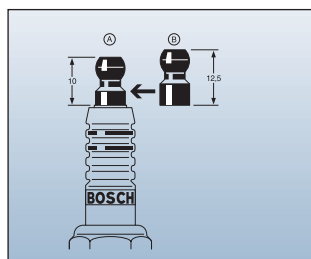
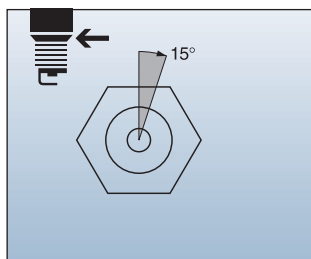

Montaggio corretto della candela d'accensione con chiave dinamometrica:

Coppia di serraggio (N • m): 10 N • m ≈ 1 kpm

Attenzione:

Le coppie di serraggio indicate valgono per le filettature a secco, non ingrassate e non oliate e per anelli di tenuta nuovi.

In caso di filettatura lubrificata le coppie di serraggio indicate vanno ridotte di 1/3.

Montaggio corretto della candela d'accensione senza chiave dinamometrica:

Attenzione:

Con la mano avvitare la candela d'accensione finché poggia sulla testata. Le candele d'accensione con sede di tenuta piana e guarnizione nuova vengono quindi girate ancora di ca. 90° con la chiave per candele. Le candele d'accensione con sede di tenuta conica e quelle con anello di tenuta piatto usato vengono quindi girate ancora di ca. 15°. Le candele d'accensione con anello di tenuta massiccio devono essere montate solo utilizzando una chiave dinamometrica.

Connettori di raccordo per candele d'accensione

Attenzione:

Nel motore possono essere montate candele d'accensione la cui lunghezza è diversa da quella delle candele d'accensione Bosch.

1. Svitare le vecchie candele d'accensione.
2. Confrontarle con le nuove candele d'accensione Bosch.
3. Se le candele d'accensione sostituite sono più lunghe delle candele d'accensione Bosch, sostituire il connettore di raccordo A con il dado di raccordo B più lungo fornito a corredo.

Attenzione!

Le raccomandazioni per le candele d'accensione, a meno che non provengano dalla Casa costruttrice della relativa autovettura o dal costruttore del motore, vengono stabilite da Bosch. Le candele d'accensione consigliate valgono per condizioni di esercizio normali nei modelli di serie, ma non per i modelli da competizione, speciali e ad alte prestazioni, salvo che tali modelli non siano espressamente specificati.

L'impiego di gradi termici diversi da quelli consigliati può rendersi necessario a causa di particolari condizioni di impiego. Qualora non siano disponibili candele d'accensione con la distanza elettrodi prescritta, la distanza elettrodi deve essere registrata. A tale scopo consigliamo di impiegare il calibro Bosch per candele d'accensione (vedi pagina A 41).

Accessori

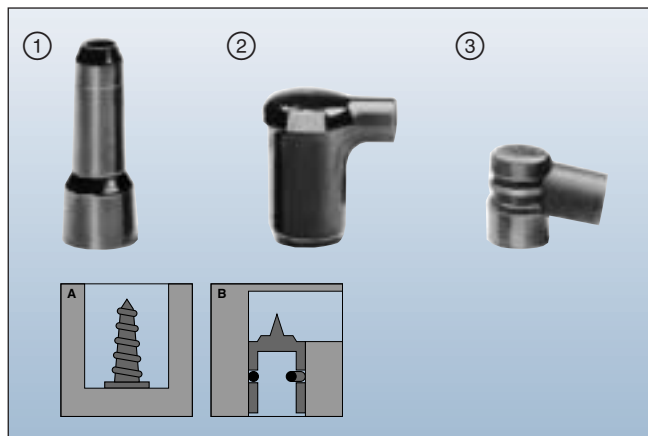

① – ③ Cappucci candela (senza soppressione disturbi)

Raccordo candela	Lungh. mm	Cavo acc. Ø mm	Osservazioni	Fig.	N. d'ordinazione
M4	52	7		① A	0 356 002 001
	39/35 ¹⁾	7		② B	0 356 050 001
a tenuta d'acqua					
M4	24/30 ¹⁾	5	Per candela d'accensione(WK ..) in esecuzione corta (WS..)	③ A	0 356 050 009
				③ A	0 356 050 010

¹⁾ Lato candela d'accensione/lato cavo d'accensione

④ Calibro per candele d'accensione

per controllare e registrare la distanza elettrodi

N. d'ordinazione **0 986 600 000**

Pasta isolante (non raff.)

Colore: bianco

Punto di fusione: 320°C

Caratteristiche: di consistenza cerosa, inodore, migliora le caratteristiche di isolamento sui collegamenti del lato secondario dell'impianto di accensione, impedisce le scariche in testa delle candele. Impiego: cappucci candela, cappucci anti-disturbo, cappucci di protezione, calotte distributore, ecc.

Foglio dati di sicurezza CE: **1 987 123 010**

Tubetto da 45 ml **1 987 123 010**

Dado di raccordo (non raff.)

Per candele d'accensione con filettatura di raccordo M4.

Zinco pressofuso, lucido, unità confezione 25 pezzi

Lunghezza 10 mm **1 243 345 023**

Lunghezza 12,5 mm **1 243 345 025**

Anello di tenuta piatto (non raff.)

Per candele d'accensione con filettatura di avvitamento

M 14 x 1,25 **1 240 280 028**

Explicación de la fórmula de tipo



Forma de asiento y rosca	A ¹⁴	D ^{20,8}	E ¹²	F ¹⁶	H ¹⁶	K ^{14*}	L ¹⁴	M ²⁶
	M 12x1,25	M 18x1,5	M 10x1,0	M 14x1,25	M 14x1,25	M 14x1,25	M 14x1,25	M 18x1,5
Ejecución	B Impermeable, para cable de encendido apantallado de 7 mm Ø		C Impermeable, para cable de encendido apantallado de 5 mm Ø		E Buja de chispa deslizante sin electrodo de masa	G Buja de chispa deslizante con electrodo(s) de masa		H Media rosca
Índice de grado térmico	13 12 11 10 9 8 7 6 5 4 3 2 09 08 07 06							
Longitud de rosca/posición de chispa	A $\begin{matrix} \uparrow 12,7 \\ \downarrow \end{matrix}$ $\begin{matrix} \uparrow *11,2 \\ \downarrow \end{matrix}$ $\begin{matrix} \rightarrow 1 \\ \leftarrow \end{matrix}$		B $\begin{matrix} \uparrow 12,7 \\ \downarrow \end{matrix}$ $\begin{matrix} \uparrow *11,2 \\ \downarrow \end{matrix}$ $\begin{matrix} \rightarrow 3 \\ \leftarrow \end{matrix}$		C $\begin{matrix} \uparrow 19 \\ \downarrow \end{matrix}$ $\begin{matrix} \uparrow 17,5 \\ \downarrow \end{matrix}$ $\begin{matrix} \rightarrow 1 \\ \leftarrow \end{matrix}$		H $\begin{matrix} \uparrow 19 \\ \downarrow \end{matrix}$ $\begin{matrix} \uparrow 17,5 \\ \downarrow \end{matrix}$ $\begin{matrix} \rightarrow 7 \\ \leftarrow \end{matrix}$	
	J $\begin{matrix} \uparrow 19 \\ \downarrow \end{matrix}$ $\begin{matrix} \uparrow 17,5 \\ \downarrow \end{matrix}$ $\begin{matrix} \rightarrow 8 \\ \leftarrow \end{matrix}$		K $\begin{matrix} \uparrow 19 \\ \downarrow \end{matrix}$ $\begin{matrix} \uparrow 17,5 \\ \downarrow \end{matrix}$ $\begin{matrix} \rightarrow 4 \\ \leftarrow \end{matrix}$		S $\begin{matrix} \uparrow 26,5 \\ \downarrow \end{matrix}$ $\begin{matrix} \uparrow 25 \\ \downarrow \end{matrix}$ $\begin{matrix} \rightarrow 5 \\ \leftarrow \end{matrix}$		T $\begin{matrix} \uparrow 26,5 \\ \downarrow \end{matrix}$ $\begin{matrix} \uparrow 25 \\ \downarrow \end{matrix}$ $\begin{matrix} \rightarrow 7 \\ \leftarrow \end{matrix}$	
	U $\begin{matrix} \uparrow 26,5 \\ \downarrow \end{matrix}$ $\begin{matrix} \uparrow 25 \\ \downarrow \end{matrix}$ $\begin{matrix} \rightarrow 9 \\ \leftarrow \end{matrix}$							
Versión de los electrodos de masa	D		T		Q			
Material de los electrodos centrales	C Cromo-níquel con núcleo de cobre		E Níquel-Itrio con núcleo de cobre		P Platino		S Plata	
							I Iridio	
Tipo de ejecución	R Resistencia a la electroerosión		S $\begin{matrix} \rightarrow 0,7 \\ \leftarrow \end{matrix}$		T $\begin{matrix} \rightarrow 0,8 \\ \leftarrow \end{matrix}$		U $\begin{matrix} \rightarrow 1,0 \\ \leftarrow \end{matrix}$	
	W $\begin{matrix} \rightarrow 0,9 \\ \leftarrow \end{matrix}$		X $\begin{matrix} \rightarrow 1,1 \\ \leftarrow \end{matrix}$		Y $\begin{matrix} \rightarrow 1,5 \\ \leftarrow \end{matrix}$		Z $\begin{matrix} \rightarrow 2,0 \\ \leftarrow \end{matrix}$	

* El largo de la rosca para bujías con forma de asiento D y posición de chispa A o B es de 10,9 mm.

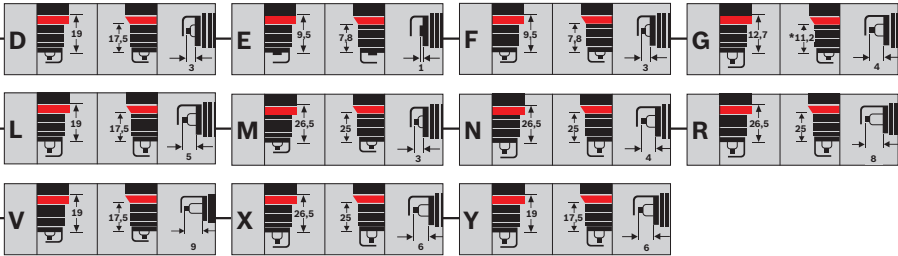
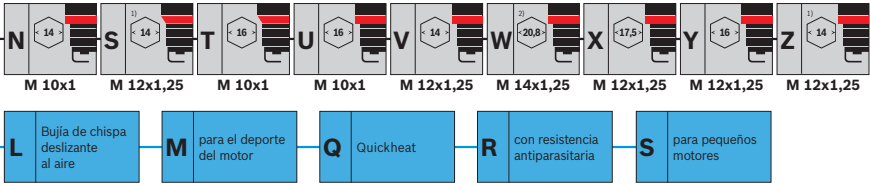

0 Diferencias respecto a la ejecución básica							
1 Ejecución PO con electrodo de masa de Ni							
2 Electrodo de masa de dos materiales							
3 Rosca de largo especial							
4 Pie de aislador prolongado							
9 Ejecución especial							
	Electrodo central con placa de metal noble soldada Diámetro posible 0,8 ó 1, 1 mm	Electrodo central con placa de metal noble soldada Diámetro posible 0,6 ó 0,8 mm	Electrodo de masa De un material Níquel-itrío	Electrodo de masa De dos materiales Níquel-itrío	Electrodo de masa De un material Níquel-itrío con suplemento de metal noble aleado al láser	Electrodo de masa De dos materiales Níquel-itrío con suplemento de metal noble aleado al láser	Electrodo de masa itrio-níquel unario con espiga de metal precioso soldada con láser de 0,6 mm Ø
10	●	-	●	-	-	-	-
15	●	-	●	-	-	-	-
22	●	-	-	-	●	-	-
222	●	-	-	-	-	●	-
23	-	●	-	-	●	-	-
232	-	●	-	-	-	-	-
30	-	●	●	-	-	-	-
302	-	●	-	●	-	-	-
33	-	●	-	-	●	-	-
332	-	●	-	-	-	●	-
35	-	●	-	-	-	-	●

1) Hexágono doble 2) Ancho de llave 19,0 mm en el modelo de motores pequeños WS

Técnica de la chispa de bujías de encendido



Electrodo de cubierta – electrodo central (fig. a).
Electrodo lateral – electrodo central (fig. b).

Bujías de encendido con técnica de chispa al aire

La chispa de encendido salta directamente del electrodo central al de masa, atravesando la mezcla de aire y combustible que se encuentra entre ambos electrodos (fig. a, b, c).

Las ventajas:

- ▶ Gran seguridad de encendido durante toda la vida útil
- ▶ Buen comportamiento de arranque en frío
- ▶ poca demanda de tensión de encendido

Electrodo de masa perfilado – electrodo central (fig. c).

Los cantos vivos adicionales interiores que se forman con el perfil del electrodo de masa proporcionan, en combinación con el espacio ampliado entre los electrodos, una transmisión más sencilla y aún más efectiva de la energía térmica de la chispa a la mezcla de aire y combustible (fig. c).

Las ventajas:

- ▶ Gran seguridad de encendido por la rapidez con que salta la chispa y se inflama la mezcla
- ▶ Seguridad adicional en el arranque en frío, también con una tensión de a bordo baja
- ▶ Mejor combustión, lo que protege el motor y, especialmente, el catalizador
- ▶ Reducción adicional del consumo de combustible al evitar fallos de encendido



Electrodo lateral – superficie de aislador – electrodo central

Electrodo lateral – electrodo central o electrodo lateral – superficie de aislador – electrodo central

Bujías de encendido con técnica de chispa deslizante

Los electrodos de masa están instalados por construcción de modo que puedan formarse exclusivamente chispas deslizantes al aire particularmente largas y potentes (fig. d).

Las ventajas:

- ▶ Mayor seguridad de encendido durante toda la vida útil
- ▶ Protección óptima del catalizador
- ▶ Demanda de tensión de encendido particularmente baja
- ▶ Efecto de autolimpieza en caso de formación de hollín
- ▶ Mayor vida útil por disposición de varios electrodos de masa

Bujías de encendido con técnica de chispa deslizante al aire

La chispa de encendido elige la mejor vía para el encendido seguro desde el electrodo central hasta el electrodo de masa, ya sea como chispa al aire o como chispa deslizante al aire. En el encendido, la chispa al aire salta directamente del electrodo central al electrodo de masa. La chispa se desliza sobre portadores de carga presentes en la punta del pé do aislador e salta sobre la forma de una faja aérea para el electrodo masa (fig. e).

Las ventajas:

- ▶ Mayor seguridad de encendido durante toda la vida útil
- ▶ Mejor comportamiento de arranque en frío
- ▶ Escasa demanda de tensión de encendido
- ▶ Efecto de autolimpieza en caso de formación de hollín
- ▶ Protección óptima del catalizador
- ▶ La disposición de varios electrodos de masa incrementa la vida útil

Aspecto de las bujías de encendido



1 + 2 Normal

Pie del aislador de color blanco o amarillo grisáceo hasta pardo corzo. El motor está a punto. Se ha elegido el grado térmico correcto.

El ajuste de la mezcla y del encendido son perfectos, no hay fallos de encendido, el sistema de arranque en frío funciona.

No hay residuos de aditivos del combustible que contengan plomo ni de componentes de aleación del aceite del motor. No existe sobrecarga térmica.

3 + 4 Bujía cubierta de hollín

Pie del aislador, electrodos y cuerpo de la bujía cubiertos de hollín de color negro mate y aspecto aterciopelado.

Causa: ajuste incorrecto de la mezcla (carburador, inyección): mezcla demasiado rica, filtro del aire muy sucio, dispositivo automático de arranque defectuoso o el cable de mando del estrangulador se ha estirado demasiado, recorridos predominantemente cortos, bujía demasiado fría, índice del grado térmico demasiado bajo.

Repercusiones: fallos del encendido, mal comportamiento de arranque en frío.

Remedio: ajustar correctamente la mezcla y el dispositivo de arranque, revisar el filtro del aire.

5 + 6 Bujía engrasada

Pie del aislador, electrodos y cuerpo de la bujía cubiertos de hollín aceitoso brillante o de carbonilla.

Causa: demasiado aceite en la cámara de combustión. Excesivo nivel de aceite, segmentos de pistón, cilindros y guías de válvulas muy desgastados. En motores de gasolina de dos tiempos, demasiado aceite en la mezcla.

Repercusiones: fallos del encendido, mal comportamiento de arranque.

Remedio: revisar el motor, emplear una mezcla correcta de combustible y aceite, montar nuevas bujías de encendido.



7 Ferroceno

Pie del aislador, electrodos y en parte cuerpo de la bujía cubiertos de sedimentos rojos-naranja firmemente adheridos.

Causa: Aditivos del combustible con contenido de hierro. Los sedimentos se forman durante el funcionamiento normal después de unos pocos miles de kilómetros.

Repercusiones: La capa con contenido de hierro es eléctricamente conductiva y provoca fallos del encendido.

Remedio: Montar bujías de encendido nuevas; limpiarlas resulta inútil.

8 Depósitos de plomo

El pie del aislador presenta en algunos puntos una vitrificación pardo-amarillenta, que puede adoptar una coloración verdosa.

Causa: aditivos con plomo en el combustible. La vitrificación se forma al someter el motor a una carga elevada después de haber funcionado largo tiempo a carga parcial.

Repercusiones: con cargas elevadas, la capa se torna electroconductora y causa fallos del encendido.

9 + 10 Grandes depósitos de plomo

El pie del aislador presenta en algunos puntos una gruesa vitrificación pardo-amarillenta, que puede adoptar una coloración verdosa.

Causa: aditivos con plomo en el combustible. La vitrificación se forma al someter el motor a una carga elevada después de haber funcionado largo tiempo a carga parcial.

Repercusiones: con cargas elevadas, la capa se torna electroconductora y causa fallos del encendido.

Remedio: montar bujías de encendido nuevas; limpiarlas resulta inútil.

11 + 12 Formación de ceniza

Gruesa capa de ceniza proveniente de aditivos del aceite y del combustible, depositada sobre el pie del aislador, en el espacio de ventilación (rendija anular) y sobre el electrodo de masa. Estructura entre suelta y semejante a la escoria.

Causa: componentes de aleación, procedentes especialmente del aceite, pueden depositar esta ceniza en la cámara de combustión y sobre la cara de la bujía.

Repercusiones: puede causar autoencendido con pérdida de potencia e incluso daños en el motor.

Remedio: poner el motor a punto. Montar bujías nuevas, emplear eventualmente otro aceite.

Aspecto de las bujías de encendido



13



14



15



13 Electrodo central parcialmente fundido

Electrodo central parcialmente fundido, punta del pie del aislador cubierta de burbujas, esponjosa y reblandecida.

Causa: sobrecarga térmica debida, por ejemplo, a un ajuste demasiado avanzado del punto de encendido, residuos de combustión en la cámara de combustión, válvulas defectuosas, distribuidor de encendido deteriorado y combustible de calidad insuficiente. Posibilidad de que el grado térmico sea demasiado bajo.

Repercusiones: fallos del encendido, pérdida de potencia (daños en el motor).

Remedio: revisar el motor, el encendido y la preparación de la mezcla. Montar bujías nuevas con el grado térmico correcto.

14 Electrodo central completamente fundido

Electrodo central completamente fundido; al mismo tiempo, electrodo de masa muy deteriorado.

Causa: sobrecarga térmica debida, por ejemplo, a un ajuste demasiado avanzado del punto de encendido, residuos de combustión en la cámara de combustión, válvulas defectuosas, distribuidor de encendido deteriorado y combustible de calidad insuficiente.

Repercusiones: fallos de encendido, pérdida de potencia, eventuales daños en el motor. Se puede agrietar el pie del aislador debido a sobrecalentamiento del electrodo central.

Remedio: revisar el motor, el encendido y la preparación de la mezcla. Montar nuevas bujías de encendido.

15 Electrodo central parcialmente fundido

Electrodos con aspecto de coliflor. Posible precipitación de sustancias ajenas a la bujía.

Causa: sobrecarga térmica debida, por ejemplo, a un ajuste demasiado avanzado del punto de encendido, residuos de combustión en la cámara de combustión, válvulas defectuosas, distribuidor de encendido deteriorado y calidad insuficiente del combustible.

Repercusiones: antes del fallo total (daños en el motor), se produce pérdida de potencia.

Remedio: revisar el motor, el encendido y la preparación de la mezcla. Montar nuevas bujías de encendido.



16 Fuerte desgaste del electrodo central

Causa: las bujías de encendido no se han cambiado en el intervalo previsto.

Repercusiones: fallos de encendido, especialmente al acelerar (la tensión de encendido ya no es suficiente para compensar la gran separación de los electrodos). Mal comportamiento de arranque.

Remedio: Montar nuevas bujías de encendido.



17 Fuerte desgaste del electrodo de masa

Causa: aditivos agresivos del combustible y del aceite.

Condiciones de flujo desfavorables en la cámara de combustión, debidas eventualmente a depósitos, picado del motor. No existe sobrecarga térmica.

Repercusiones: fallos de encendido, especialmente al acelerar (la tensión de encendido ya no es suficiente para compensar la gran separación de los electrodos). Mal comportamiento de arranque.

Remedio: Montar nuevas bujías de encendido.



18 Rotura del pie del aislador

Causa: daños de origen mecánico debidos a golpe, caída o presión sobre el electrodo central por manipulación inadecuada.

En casos extremos, debido a depósitos entre el electrodo central y el pie del aislador y a corrosión del electrodo central se puede romper el pie del aislador, especialmente en caso de funcionamiento demasiado prolongado.

Repercusiones: fallos del encendido, la chispa de encendido salta en puntos a los que la mezcla recién entrada no llega con seguridad.

Remedio: Montar nuevas bujías de encendido.



A50

Consejos de Bosch



Asiento plano

M 10 x1	10...15	10...15
M 12 x1,25	15...25	15...20
M 14 x1,25 <13 mm	20...25	15...20
M 14 x1,25 >13 mm	20...40	20...30
M 18 x1,5	30...45	20...35

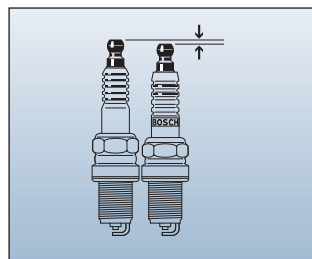
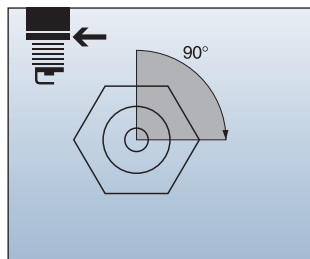

Asiento cónico

M 14 x1,25	20...40	10...20
M 18 x1,5	30...45	15...23

① en hierro colado
② en aleación ligera

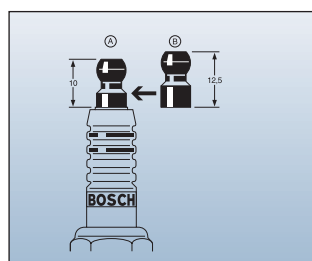
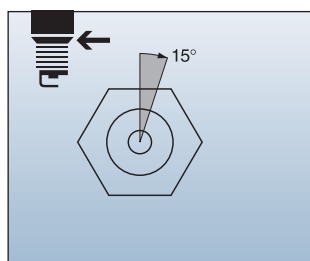

Montaje correcto de la bujía con llave dinamométrica:

Par de apriete (N · m): 10 N · m ≈ 1 kpm

Rogamos observar:

Los pares de apriete mencionados son válidos para roscas secas, no lubricadas con grasa ni aceite y para anillos obturadores nuevos.

En el caso de roscas lubricadas los pares de apriete indicados deben reducirse en 1/3.

Montaje correcto de la bujía de encendido sin llave dinamométrica:

Rogamos observar:

Enrosca con la mano la bujía de encendido hasta que haga tope en la culata. Las bujías de encendido con asiento plano y una nueva junta se giran entonces aproximadamente 90° más con la llave de bujías. Las bujías de encendido con asiento cónico y anillo obturador plano continúan girándose aprox. 15° más. Bujías con retén macizo solo se pueden montar con una llave dinamométrica.

Tuercas de conexión de bujías de encendido

Rogamos observar:

En el motor pueden estar montadas bujías que en su longitud difieran de las bujías de encendido Bosch.

1. Desenrosca las bujías de encendido viejas.
2. Compararlas con bujías de encendido Bosch nuevas.
3. Si la bujía de encendido a sustituir es más larga que la bujía Bosch, reemplazar la tuerca de conexión enroscada A por la tuerca B adjuntada, más larga.

¡A tener en cuenta!

Las recomendaciones de bujías de encendido han sido establecidas por Bosch, siempre y cuando no procedan del fabricante del vehículo o del motor. Las bujías de encendido recomendadas rigen para condiciones de servicio normales en modelos de serie, pero no para ejecuciones de competición, especiales y de alto rendimiento, a no ser que se indiquen de forma especial tales modelos.

El uso de otros grados térmicos distintos a los recomendados puede ser necesario por condiciones de servicio especiales. Separación específica entre electrodos. Si no hay disponibles bujías con la separación específica entre electrodos, será necesario reajustar la separación entre los electrodos. Recomendamos utilizar para ello la galga para bujías de encendido Bosch (véase la página A 51).

Accesorios

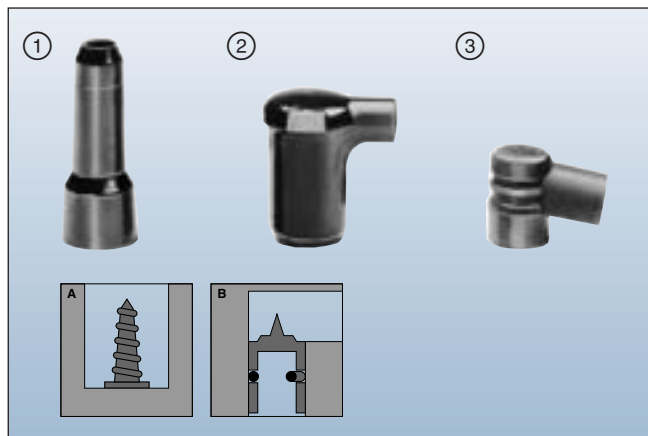

① – ③ Enchufe de bujía de encendido (no antiparasitado)

Conexión	Longitud mm	Cable de encend. Ø mm	Observaciones	Fig.	Ref. de pedido
Bujía de enc.	52	7		① A	0 356 002 001
M4	39/35 ¹⁾	7		② B	0 356 050 001
impermeable					
M4	24/30 ¹⁾	5	para bujía de ejecución corta	③ A	0 356 050 009
			(WK..)	③ A	0 356 050 010
			(WS..)		

¹⁾ Lado de la bujía/lado del cable de encendido

④ Galga para bujías de encendido

para comprobar y reajustar la separación de los electrodos

Referencia de pedido **0 986 600 000**

Pasta aislante (sin ilustración)

Color: blanco

Punto de fusión: 320°C

Propiedades: cerosa, inodora, mejora las propiedades de aislamiento en conexiones del lado secundario del encendido, impide saltos de chispa en la cabeza de las bujías
Aplicación: enchufes de bujías de encendido, enchufes antiparasitarios, caperuzas protectoras, tapas de distribuidor y similares

Hoja de datso

de seguridad CE: **1 987 123 010**

Tubo de 45 ml **1 987 123 010**

Tuerca de conexión (sin ilustración)

Para las roscas de conexión para bujías de encendido M4.

Cinc colado a presión, en blanco, unidad de embalaje con 25 unidades

Longitud 10 mm **1 243 345 023**

Longitud 12,5 mm **1 243 345 025**

Anillo obturador plano (sin ilustración)

Para las bujías de encendido con rosca para atornillar

M 14 x 1,25 **1 240 280 028**

Explicação da designação

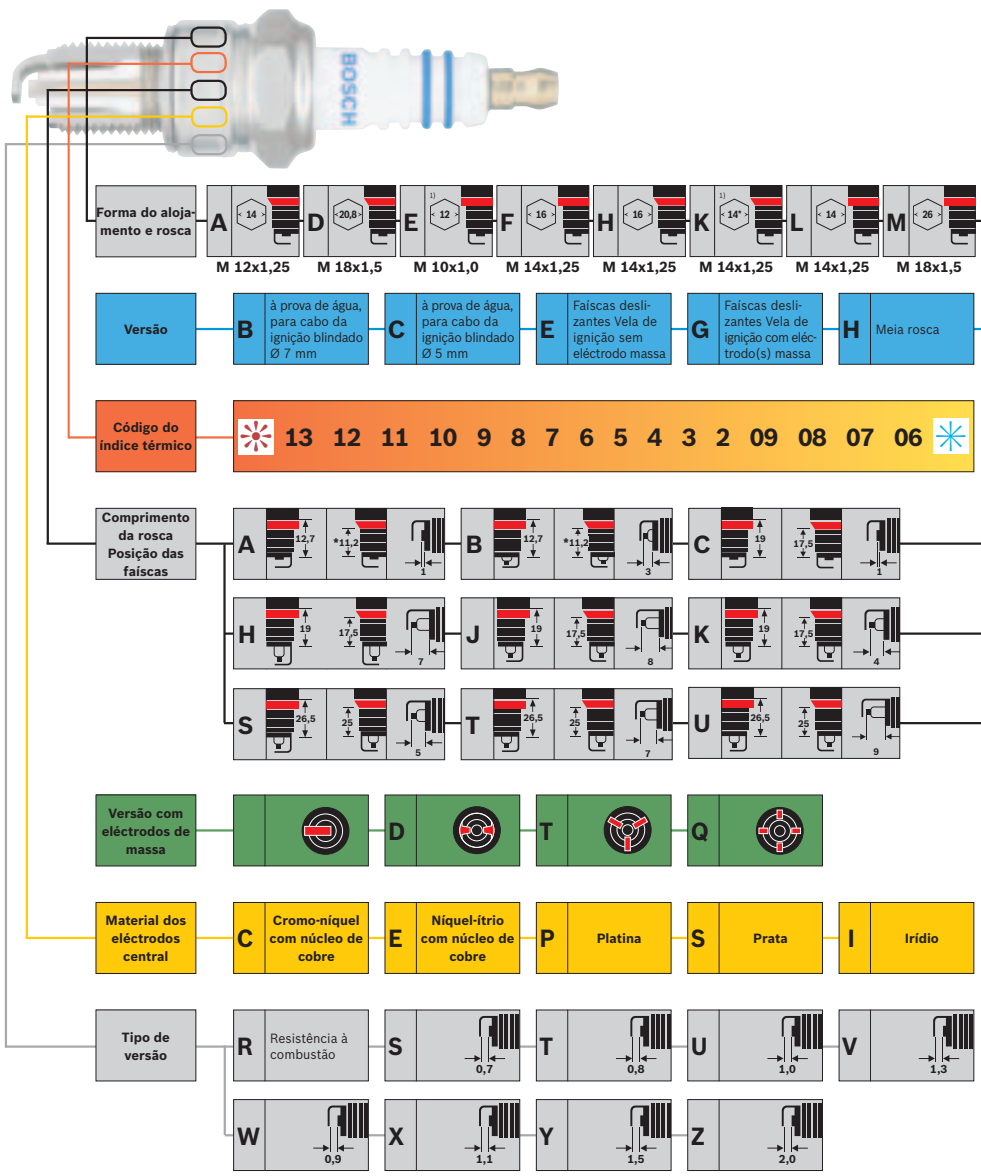

* O comprimento da rosca para velas de ignição com forma de alojamento D e posição das faíscas A ou B é de 10,9 mm.

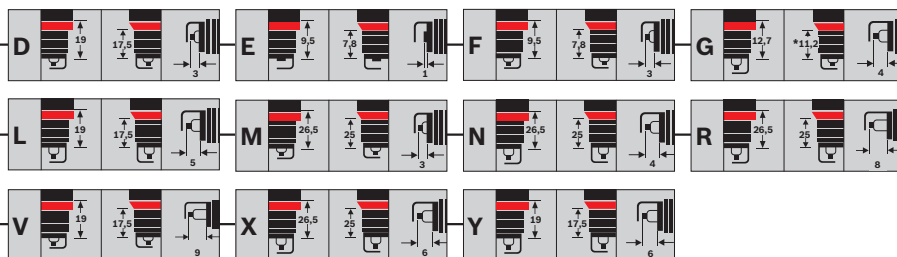
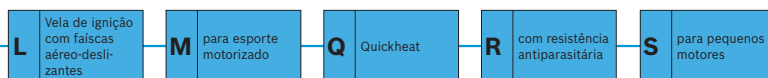
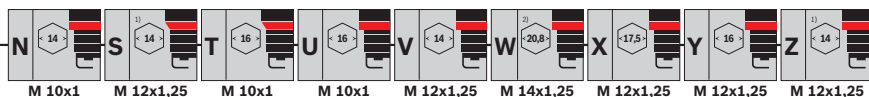

0 Desvios da versão básica

1 Versão PO com eléctrodos massa de níquel

2 Eléctrodo massa de duas materiais

3 Rosca com comprimento especial

4 Isolador do pé prolongado

9 Versão especial

	É possível um eléctrodo do meio com um pino em placazinha de metal nobre com um diâmetro de 0,8 ou 1,1 mm	É possível um eléctrodo do meio com um pino em metal nobre soldado com um diâmetro de 0,6 ou 0,8 mm	Eléctrodo de massa Substância única de níquel-ítrio	Eléctrodo de massa Substância dupla de níquel-ítrio	Eléctrodo de massa Substância única de níquel-ítrio com uma guarnição de metal nobre ligada a laser	Eléctrodo de massa Substância dupla de níquel-ítrio com uma guarnição de metal nobre ligada a laser	Eléctrodo de massa Substância única de níquel-ítrio com um pino em metal nobre soldado a laser com Ø 0,6 mm
10	●	—	●	—	—	—	—
15	●	—	●	—	—	—	—
22	●	—	—	—	●	—	—
222	●	—	—	—	—	●	—
23	—	●	—	—	●	—	—
232	—	●	—	—	—	—	—
30	—	●	●	—	—	—	—
302	—	●	—	●	—	—	—
33	—	●	—	—	●	—	—
332	—	●	—	—	—	●	—
35	—	●	—	—	—	—	●

¹⁾ Sextavado duplo ²⁾ Tamanho de chave 19,0 mm para a versão WS de motores pequenos

A tecnologia das faíscas das velas de ignição



Eléctrodo massa superior – Eléctrodo central (fig. a).
Eléctrodo lateral – Eléctrodo central (fig. b).

Eléctrodo massa perfilado – Eléctrodo central (fig. c).

Velas de ignição com tecnologia de faíscas aéreas

A faísca de ignição incendeia a mistura de ar/combustível que se encontra entre os eléctrodos, quando passa do eléctrodo central para o eléctrodo massa (fig. a, b, c).

As vantagens:

- ▶ maior segurança de ignição ao longo de toda a vida útil
- ▶ Bom comportamento no arranque a frio
- ▶ menor necessidade de tensão de ignição

As arestas vivas interiores adicionais que se formam devido ao perfil do eléctrodo de massa proporcionam, juntamente com o maior espaço entre os eléctrodos, uma transmissão mais fácil e efetiva da energia do calor da faísca para a mistura de ar/combustível (fig. c).

As vantagens:

- ▶ maior segurança de ignição graças a um salto da faísca de ignição e a uma inflamação da mistura mais rápidos
- ▶ segurança adicional no arranque a frio mesmo com tensão de bordo reduzida
- ▶ melhor combustão para protecção do motor e, em especial, do catalisador
- ▶ consumo de combustível ainda mais reduzido, já que são evitadas falhas de ignição



Eléctrodo lateral – Superfície do isolador – Eléctrodo central

Eléctrodo lateral – Eléctrodo central ou eléctrodo lateral –
Superfície do isolador – Eléctrodo central

Velas de ignição com tecnologia de faíscas deslizantes

O tipo de construção dos eléctrodos massa foi concebido de forma a que se possam formar apenas faíscas aéreo-deslizantes especialmente longas e potentes (fig. d).

As vantagens:

- ▶ segurança de ignição elevada ao longo de todo o período de utilização
- ▶ máxima proteção do catalisador
- ▶ pouca necessidade de tensão de ignição
- ▶ efeito autolimpante em caso de carbonização seca
- ▶ período de utilização mais longo graças à utilização de vários eléctrodos massa

Velas de ignição com tecnologia de faíscas aéreo-deslizantes

A faísca de ignição opta pelo melhor caminho entre os eléctrodos massa para obter para uma ignição mais segura, tanto como faísca aérea ou como faísca aéreo-deslizante. A faísca aérea salta, quando se dá a ignição, percorrendo um caminho directo do eléctrodo central para o eléctrodos de massa. A faísca aéreo-deslizante desliza através dos portadores de carga presentes na ponta do pé do isolador e salta sob a forma de uma faísca aérea para o eléctrodo massa (fig. e).

As vantagens:

- ▶ segurança de ignição elevada ao longo de todo o período de utilização
- ▶ comportamento no arranque a frio melhorado
- ▶ menor necessidade de tensão de ignição
- ▶ efeito de auto limpeza em caso de carbonização seca
- ▶ máxima proteção do catalisador
- ▶ A disposição dos vários eléctrodos de massa aumenta a vida útil

Aspecto das velas de ignição



1 + 2 Normal

O pé do isolador apresenta-se amarelado-cinza ou castanho-claro. O motor está em boas condições. O índice térmico da vela está correto. O ajuste da mistura e da ignição estão corretos, não há falhas de ignição, o dispositivo de partida a frio funciona. Não há resíduos de aditivos de combustível contendo chumbo, nem de partículas de liga do óleo do motor. Não há sobrecarga térmica.

3 + 4 Fuliginosa (Carbonização seca)

O pé do isolador, os eléctrodos e a carcaça da vela cobertos por uma camada fosca de fuligem preto-aveludada (seca).

Causas: ajuste da mistura errado (carburador, injeção): mistura muito rica, filtro do ar sujo, afogador automático com mau funcionamento ou afogador manual (Choke) puxado por longo tempo, trajectos curtos muito frequentes, vela de ignição muito fria, código do índice térmico muito baixo.

Efeitos: falhas de ignição, mau comportamento no arranque a frio.

Soluções: ajustar a mistura e o dispositivo de arranque, verificar de ar.

5 + 6 Oleosa (Carbonização oleosa)

O pé do isolador, os eléctrodos e a carcaça da vela apresentam-se cobertos por uma camada fuliginosa, brilhante e por resíduos de carvão de óleo.

Causas: demasiado óleo na câmara de combustão. Nível de óleo muito elevado, segmentos de pistão, cilindros e guias de válvula desgastados. Em motores a gasolina de 2 tempos, óleo em excesso na mistura.

Efeitos: falhas de ignição, mau comportamento na partida.

Soluções: retificar o motor, usar a proporção correta de mistura óleo/combustível, substituir as velas de ignição.



7 Ferroceno

O pé do isolador, os eléctrodos e, em parte, a caixa das velas de ignição estão cobertos por sedimentos vermelho-alaranjados aderentes.

Causa: aditivos de combustível ferrosos. O sedimento surge durante o funcionamento normal, ao fim de poucos milhares de quilómetros.

Efeitos: o revestimento ferroso tem propriedades de condução eléctrica, provocando falhas de ignição.

Soluções: Velas de ignição novas, não adianta limpar.

8 Resíduos leves de chumbo

O pé do isolador está coberto por uma fuligem amarela-castanho, que também pode ficar esverdeada.

Causas: aditivos de combustível contendo chumbo. A fuligem surge devido a uma carga elevada do motor após um longo período de funcionamento em carga parcial.

Efeitos: devido ao aumento da carga, o revestimento adquire propriedades de condução eléctrica, provocando falhas de ignição.

Soluções: substituir as velas de ignição, já que é inútil limpá-las.

9 + 10 Resíduos grossos de chumbo

O pé do isolador está parcialmente coberto por uma fuligem espessa amarelo-castanho que também pode ficar esverdeada.

Causas: aditivos de combustível contendo chumbo. A fuligem surge devido a uma carga elevada do motor após um longo período de funcionamento em carga parcial.

Efeitos: devido ao aumento da carga, o revestimento adquire propriedades de condução eléctrica, provocando falhas de ignição.

Soluções: substituir as velas de ignição, já que é inútil limpá-las.

11 + 12 Resíduos/impurezas

Existe uma camada de cinza grossa resultante de aditivos de óleo e combustível no pé do isolador, na câmara de aspiração (fenda anular) e no eléctrodo massa, de estrutura fofa até cheia de escórias.

Causas: as partículas de liga, nomeadamente do óleo, podem causar a formação desta cinza na câmara de combustão e na face da vela.

Efeitos: Pode causar ignições por incandescência com perda de potência e danos no motor.

Soluções: Afinar o motor. Substituir as velas de ignição e mudar o óleo, se necessário.

Aspecto das velas de ignição



13 Sobreaquecimento

O eléctrodo central está parcialmente fundido, a ponta do pé do isolador está esponjosa, amolecida e com bolhas.

Causas: Sobre carga térmica devido a ignições por incandescência, p. ex. em virtude de uma regulação da ignição prematura, de resíduos de combustão na câmara de combustão, de válvulas defeituosas, de um distribuidor de ignição com defeito e de qualidade insuficiente do combustível. É possível que o índice térmico seja demasiado reduzido.

Efeitos: falhas de ignição, perda de potência (danos no motor).

Soluções: verificar o motor, a ignição e a carburação. Substituir as velas de ignição, com um índice térmico correto.

14 Eléctrodo central fundido

O eléctrodo central está completamente fundido e o eléctrodo massa está parcialmente fundido.

Causas: Sobre carga térmica devido a ignições por incandescência, p. ex. em virtude de uma regulação da ignição prematura, de resíduos de combustão na câmara de combustão, de válvulas defeituosas, de um distribuidor de ignição com defeito e de qualidade insuficiente do combustível.

Efeitos: falhas de ignição, perda de potência, eventuais danos no motor. Possível ruptura no pé do isolador devido ao eléctrodo central sobre aquecido.

Soluções: Rever o motor, a ignição e a carburação. Substituir as velas de ignição.

15 Eléctrodos central e de massa fundidos

Os eléctrodos apresentam um aspecto semelhante a uma couve-flor. É possível que tenha havido condensação de materiais estranhos às velas.

Causas: Sobre carga térmica devido a ignições por incandescência, p. ex. em virtude de uma regulação da ignição prematura, de resíduos de combustão na câmara de combustão, de válvulas defeituosas, de um distribuidor de ignição com defeito e de qualidade insuficiente do combustível.

Efeitos: Antes da falha total (danos no motor), a potência diminui.

Soluções: Rever o motor, a ignição e a carburação. Substituir as velas de ignição.



16 Desgaste excessivo do eléctrodo central (erosão)

Causas: não foi respeitado o intervalo substituição das velas de ignição.

Efeitos: falhas de ignição, principalmente ao acelerar (a tensão de ignição para distâncias grandes entre eléctrodos já não é suficiente). Mau comportamento no arranque.

Soluções: substituir as velas de ignição.

17 Desgaste excessivo dos eléctrodos de massa

Causas: aditivos de combustível e de óleo agressivos. Condições de fluxo desfavoráveis na câmara de combustão, eventualmente devido a depósitos, detonações no motor. Não existe sobrecarga térmica.

Efeitos: falhas de ignição, principalmente ao acelerar (a tensão de ignição para distâncias grandes entre eléctrodos já não é suficiente). Mau comportamento na partida.

Soluções: substituir as velas de ignição.

18 Pé do isolador danificado

Causas: Danos mecânicos devido a choque, queda ou pressão sobre o eléctrodo central em caso de manuseamento impróprio. Em casos limite, os depósitos entre o eléctrodo central e o pé do isolador e a corrosão do eléctrodo central podem causar a ruptura do pé do isolador, especialmente se o tempo de funcionamento for excessivo.

Efeitos: falhas de ignição, a faísca de ignição salta nos pontos que não podem ser alcançada de modo fiável pela mistura nova.

Soluções: substituir as velas de ignição.

A60

Conselho Bosch



Alojamento estanque plano

	①	②
M 10 x1	10...15	10...15
M 12 x1,25	15...25	15...20
M 14 x1,25 <13 mm	20...25	15...20
M 14 x1,25 >13 mm	20...40	20...30
M 18 x1,5	30...45	20...35

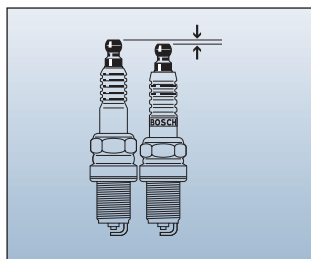
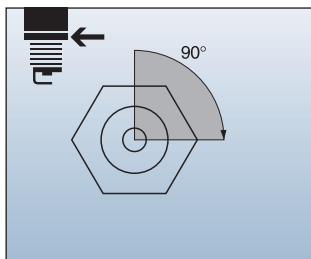

Alojamento estanque cônico

	①	②
M 14 x1,25	20...40	10...20
M 18 x1,5	30...45	15...23

① em ferro fundido
② em metal leve

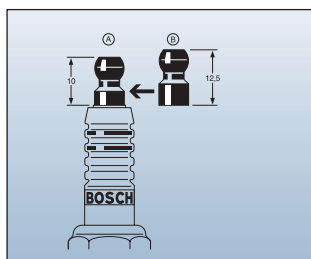
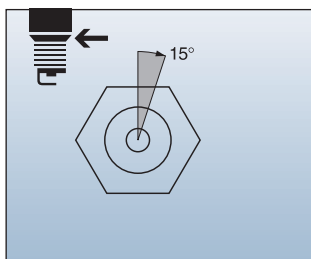

Montagem correta de velas de ignição com torquímetro:

Torque de aperto (N • m):
10 N • m ≈ 1 kpm

Observar:

Os binários de aperto mencionados são válidos para roscas secas, não lubrificadas nem oleadas e para anéis de vedação novos. No caso de roscas lubrificadas os binários de aperto mencionados têm de ser reduzidos em 1/3.

Montagem correta de velas de ignição sem torquímetro:

Observar:

Enroscar a vela de ignição manualmente na cabeça do motor até assentar. As velas de ignição com alojamento estanque plano e junta nova são enroscadas mais aprox. 90° com uma chave de velas. As velas de ignição com alojamento estanque cônico e as velas de ignição com anel de vedação plano usado são enroscadas em aprox. mais 15°. As velas de ignição com um anel de vedação compacto só podem ser montadas com uma chave dinamométrica.

Porcas de conexão das velas de ignição

Observar:

No motor, também podem estar montadas velas de ignição cujo comprimento diverge das velas da Bosch.

1. Desenroscar as velas de ignição antigas.
2. Comparar com as velas de ignição Bosch novas.
3. Se a vela de ignição substituída for mais comprida que a vela de ignição Bosch, substituir a porca de conexão enroscada A pela porca de conexão mais comprida B fornecida.

Atenção!

As recomendações sobre as velas de ignição, quando não provenientes do fabricante do motor ou do veículo, são determinadas pela Bosch. As velas de ignição recomendadas são válidas para condições de serviço normais em modelos de série, mas não para versões de corrida, especiais e de elevada performance, a não ser que esses modelos sejam alvo de referência especial.

Uma utilização de índices térmicos diferentes dos aconselhados pode tornar-se necessária devido às condições de serviço especiais. Se não existirem velas de ignição com a distância entre eléctrodos prescrita disponíveis, a distância entre eléctrodos tem de ser reajustada. Para tal, aconselhamos a utilização do calibrador de velas de ignição da Bosch (ver pág. A 61).

Acessórios

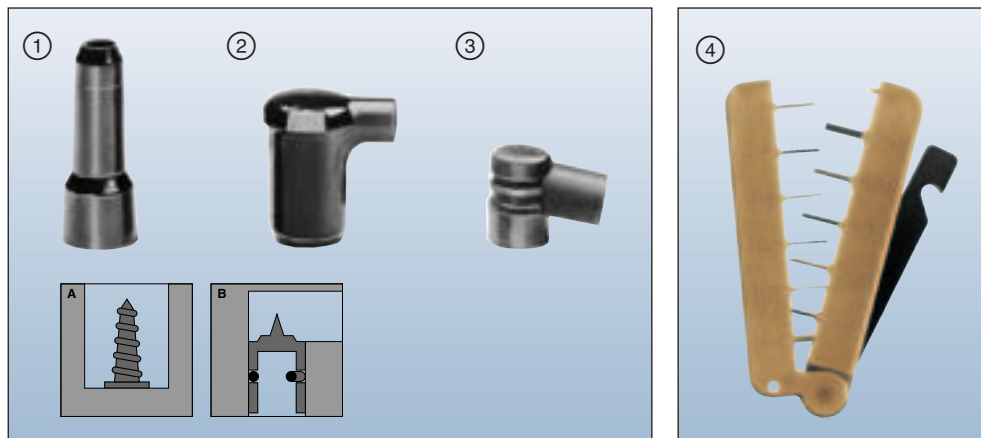

① – ③ Terminal da vela (sem interferências)

Conexão ignição	Longua mm	Cabo de ignição Ø mm	Observações.	Fig.	Número de pedido
M4	52	7		① A	0 356 002 001
	39/35 ¹⁾	7		② B	0 356 050 001
à prova de água					
M4	24/30 ¹⁾	5	para vela de ignição de formato curto	(WK..) ③ A	0 356 050 009
				(WS..) ③ A	0 356 050 010

¹⁾ Lado da vela de ignição/lado do cabo de ignição

④ Calibre de velas de ignição

para verificar e reajustar a distância entre eletrodos

Número de pedido **0 986 600 000**

Pasta isoladora (sem fig.)

Cor: branco

Ponto de fusão: 320 °C

Propriedades: ceráceo, inodoro, aperfeiçoamento das propriedades do isolamento em ligações do lado secundário do sistema de ignição, protecção contra descargas eléctricas na cabeça nas velas de ignição Utilização: terminal da vela, conexão antiparasitária, capa de protecção, tampa do distribuidor, etc.

Folhas de dados de

segurança CE: **1 987 123 010**

Bisnaga de 45 ml **1 987 123 010**

Porca de conexão (sem fig.)

Para roscas de conexão de velas de ignição M4. Zinco fundido sob pressão, polida, embalagem com 25 unidades

Comprimento 10 mm **1 243 345 023**

Comprimento 12,5 mm **1 243 345 025**

Anel de vedação plano (sem fig.)

Para velas de ignição com rosca macho

M 14 x 1,25 **1 240 280 028**

Uitleg typeformules



Vorm van de zitting en schroefdraad	A	D	E	F	H	K	L	M
	14	20,8	12	16	16	14*	14	26
	M 12x1,25	M 18x1,5	M 10x1,0	M 14x1,25	M 14x1,25	M 14x1,25	M 14x1,25	M 18x1,5

Uitvoering	B	C	E	G	H
	watdicht, voor gepantserde bougiekabel Ø 7 mm	watdicht, voor gepantserde bougiekabel Ø 5 mm	Glijvonk Bougie zonder massa-elektrode	Glijvonk Bougie met massa-elektrode(n)	Halve schroefdraad

Kengetal van de warmtegraad											
-----------------------------	--	--	--	--	--	--	--	--	--	--	--

Schroefdraad-lengte Vonkpositie	A	B	C	H	J	K	S	T	U
	12,7	12,7	19	19	19	19	26,5	26,5	26,5
	11,2	11,2	17,5	17,5	17,5	25	25	25	

Uitvoering massa-elektroden	D	T	Q
-----------------------------	---	---	---

Uitvoering midden-elektroden	C	E	P	S	I
	Chroom-nikkel met koperen kern	Nikkel-yttrium met koperen kern	Platina	Zilver	Iridium

Uitvoering	R	S	T	U	V
	Brandweerstand	0,7	0,8	1,0	1,3
	W	X	Y	Z	
	0,9	1,1	1,5	2,0	

* De schroefdraadlengte voor bougies met zittingvorm D en vonkpositie A of B bedraagt 10,9 mm.

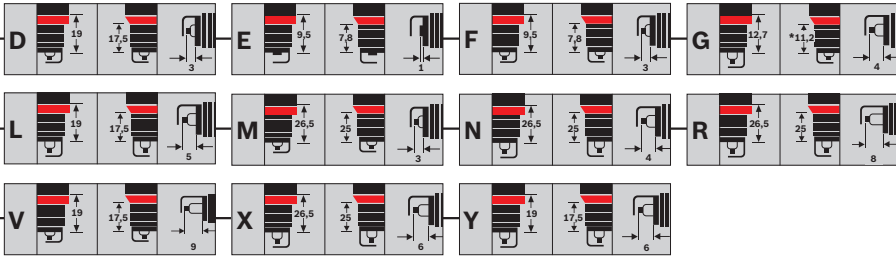
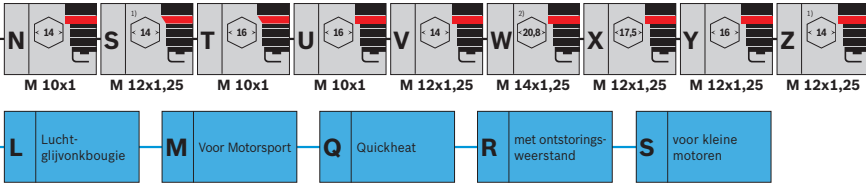

0 Afwijkingen van de basisuitvoering							
1 P0-uitvoering met nikkel-massa-elektrode							
2 Uit twee materialen samengestelde massa-elektrode							
3 Schroefdraad met speciale lengte							
4 Verlengde isolatorvoet							
9 Speciale uitvoering							
	Middenelektrode met opgelaste edelmetaalplaat, diameter 0,8 of 1,1 mm mogelijk	Middenelektrode met opgelaste edelmetaalstift met een diameter van 0,6 of 0,8 mm mogelijk	Massa-elektrode Uit een materiaal, nikkel-yttrium	Massa-elektrode Uit twee stoffen samengesteld, nikkel-yttrium	Massa-elektrode Uit een materiaal, nikkel-yttrium met lasergelegeerde edelmetalaalag	Massa-elektrode Uit twee stoffen samengesteld, nikkel-yttrium met lasergelegeerde edelmetalaalag	Massa-elektrode met één stof nikkel-yttrium en met laser gelaste edelmetalen stift met Ø 0,6 mm
10	●	-	●	-	-	-	-
15	●	-	●	-	-	-	-
22	●	-	-	-	●	-	-
222	●	-	-	-	-	●	-
23	-	●	-	-	●	-	-
232	-	●	-	-	-	●	-
30	-	●	●	-	-	-	-
302	-	●	-	●	-	-	-
33	-	●	-	-	●	-	-
332	-	●	-	-	-	●	-
35	-	●	-	-	-	-	●

¹⁾ Dubbele inbus ²⁾ Sleutelbreedte 19,0 mm bij kleine motoren uitvoering WS

Bougievonktechnologie



Bovenelektrode – middelelektrode (afb. a).
Zijelektrode – middelelektrode (afb. b).

Bougies met luchtvonktechnologie

De ontstekingsvonk dringt rechtstreeks tussen de middelelektrode en de massa-elektrode door het lucht-brandstof-mengsel, dat zich tussen de elektroden bevindt (afb. a, b, c).

De voordelen:

- ▶ Hoge ontstekingsveiligheid gedurende de gehele gebruiksduur
- ▶ Goed koudestartgedrag
- ▶ Gering verbruik van ontstekingsspanning

Geprofileerde massa-elektrode – middelelektrode (afb. c).

De binnen liggende, extra scherpe kanten, die gevormd worden door het profiel van de massa-elektrode, zorgen in combinatie met de vergrootte ruimte tussen de elektroden voor een gemakkelijkere, nog effectievere overdracht van de warmte-energie van de vonk aan het brandstof-lucht-mengsel (afb. c).

De voordelen:

- ▶ Hoge ontstekingsveiligheid door snellere overslag van de ontstekingsvonk en ontvlammen van het mengsel
- ▶ Extra koudestartveiligheid ook bij lage boordspanning
- ▶ Betere verbranding ter bescherming van de motor en vooral van de katalysator
- ▶ Extra verminderd brandstofverbruik door voorkomen van overslagen van de motor



Zijelektrode – isolatoroppervlak – middenelektrode

Bougies met glijvonktechnologie

De massa-elektroden zijn constructief zodanig geplaatst, dat zij uitsluitend de bijzonder lange en krachtige lucht-glijvonken kunnen vormen (afb. d).

De voordelen:

- ▶ Verhoogde ontstekingsveiligheid gedurende de gehele gebruiksduur
- ▶ Optimale bescherming van de katalysator
- ▶ Bijzonder gering verbruik van ontstekingsspanning
- ▶ Zelfreinigende werking bij roetvorming
- ▶ Langere gebruiksduur door plaatsing van meerdere massa-elektroden



Zijelektrode – middenelektrode of zijelektrode – isolatoroppervlak – middenelektrode

Bougies met lucht-glijvonktechnologie

De ontstekingsvonk kiest de voor de veilige ontsteking beste weg van de middenelektrode naar de massaelektrode, of als luchtvonk, of als lucht-glijvonk. De luchtvonk springt tijdens de ontsteking rechtstreeks van de middenelektrode naar de massa-elektrode. De lucht-glijvonk glijdt via aanwezige geladen deeltjes op het punt van de isolatorvoet en springt als luchtvonk naar de massa-elektrode (afb. e).

De voordelen:

- ▶ Verhoogde ontstekingsveiligheid gedurende de gehele gebruiksduur
- ▶ Verbeterd koudstartgedrag
- ▶ Gering verbruik van ontstekingsspanning
- ▶ Zelfreinigende werking bij roetvorming
- ▶ Optimale bescherming van de katalysator
- ▶ De groepering van meerdere massa-elektroden – verlengt de gebruiksduur



Bougiegezichten



1 + 2 Normaal

Isolatorvoet grijswit-grijsgeel tot lichtbruin van kleur. Motor is in orde. Warmtegraad correct geselecteerd. Mengselinstelling en ontstekingsinstelling zijn onberispelijk, geen overslagen van de motor, koudestartinrichting werkt. Geen residu van loodhoudende brandstofadditieven of legerings-elementen van de motorolie. Geen thermische overbelasting.

3 + 4 Vervuild door roetvorming

Isolatorvoet, elektroden en bougiehuis bedekt met fluweelachtige, matzwarte roet.

Oorzaak: Foutieve mengselinstelling (carburateur, injectie):

Mengsel te rijk, luchtfilter sterk vervuild, automatische choke niet in orde of chokekabel te lang getrokken, vooral kortafstandsverkeer, bougie te koud, kengetal van de warmtegraad te laag.

Gevolgen: Overslagen van de motor, slecht koudestartgedrag.

Oplossing: Mengsel en startgedeelte van de carburateur correct instellen, luchtfilter controleren.

5 + 6 Vervuiling door olie

Isolatorvoet, elektroden en bougiehuis bedekt met vet glanzende roet of koolaanslag.

Oorzaak: Te veel olie in de verbrandingskamer. Oliepeil te hoog, sterk versleten zuigerringen, cilinders en klepgeleidingen. Bij tweetakt-ottomotoren te veel olie in het mengsel.

Gevolgen: Overslagen van de motor, slecht startgedrag.

Oplossing: Motor reviseren, correct brandstof-olie-mengsel, nieuwe bougies.



7 Ferroceen

Isolatorvoet, elektroden en gedeeltes van het bougiehuis zijn bedekt met oranjerode vastzittende afzettingen.

Oorzaak: IJzerhoudende brandstofadditieven. De afzettingen ontstaan tijdens normaal bedrijf na enkele duizend kilometer.

Gevolgen: De ijzerhoudende aanslag is elektrisch geleidend en veroorzaakt overslagen.

Oplossing: Nieuwe bougies, reinigen helpt niet.

8 Vervuiling door lood

Isolatorvoet vertoont plaatselijk een bruingele aanslag, die ook een groenachtige tint kan hebben.

Oorzaak: Loodhoudende brandstofadditieven. De aanslag ontstaat bij grote motorbelasting na een langere periode van deellastbedrijf.

Gevolgen: Bij grotere belasting wordt de aanslag elektrisch geleidend en veroorzaakt overslagen van de motor.

Oplossing: Nieuwe bougies, reinigen helpt niet.

9 + 10 Sterke vervuiling door lood

Isolatorvoet vertoont plaatselijk een dikke bruingele aanslag, die ook een groenachtige tint kan hebben.

Oorzaak: Loodhoudende brandstofadditieven. De aanslag ontstaat bij grote motorbelasting na een langere periode van deellastbedrijf.

Gevolgen: Bij grotere belasting wordt de aanslag elektrisch geleidend en veroorzaakt overslagen van de motor.

Oplossing: Nieuwe bougies, reinigen helpt niet.

11 + 12 Asvorming

Sterke asaanslag uit olie- en brandstofadditieven op de isolatorvoet, in de ademruimte (ringvormige gleuf) en op de massa-elektrode. Losse tot slakachtige opbouw.

Oorzaak: Legeringselementen vooral afkomstig uit olie kunnen deze als in de verbrandingskamer en op het bougiegezicht achterlaten.

Gevolgen: Kan leiden tot gloei-ontsteking met vermogensverlies en motorschade.

Oplossing: Motor repareren. Nieuwe bougies, eventueel andere olie gebruiken.

Bougiegezichten



13



14



15



13 Aangesmolten middenelektrode

Middenelektrode aangesmolten, blaasvormig, sponsachtig, zacht punt van de isolatorvoet.

Oorzaak: Thermische overbelasting door gloeiontstekingen, bijv. door te vroege ontstekingsinstelling, verbrandingsresten in de verbrandingskamer, defecte kleppen, foutieve stroomverdeler en ontoereikende brandstofkwaliteit. Eventueel te lage warmtegraad.

Gevolgen: Overslagen van de motor, vermogensverlies (motorschade).

Oplossing: Motor, ontsteking en mengselvoorbereiding controleren. Nieuwe bougies met de correcte warmtegraad.

14 Weggesmolten middenelektrode

Middenelektrode weggesmolten, massa-elektrode tegelijkertijd sterk aangegrepen

Oorzaak: Thermische overbelasting door gloeiontstekingen, bijv. door te vroege ontstekingsinstelling, verbrandingsresten in de verbrandingskamer, defecte kleppen, foutieve stroomverdeler en ontoereikende brandstofkwaliteit.

Gevolgen: Overslagen van de motor, vermogensverlies, eventueel motorschade. Scheuren van de isolatorvoet door oververhitte middenelektrode mogelijk.

Oplossing: Motor, ontsteking en mengselvoorbereiding controleren. Nieuwe bougies.

15 Aangesmolten middenelektrode

Bloemkoolachtig uiterlijk van de elektroden. Eventueel aanslag van bougievreemde materialen.

Oorzaak: Thermische overbelasting door gloeiontstekingen, bijv. door te vroege ontstekingsinstelling, verbrandingsresten in de verbrandingskamer, defecte kleppen, foutieve stroomverdeler en ontoereikende brandstofkwaliteit.

Gevolgen: Vóór een totale uitval (motorschade) treedt vermogensverlies op.

Oplossing: Motor, ontsteking en mengselvoorbereiding controleren. Nieuwe bougies.



16 Sterke slijtage van de middenelektrode

Oorzaak: Vervangingsinterval van de bougies niet in acht genomen.

Gevolgen: Afslaan van de motor, vooral tijdens het accelereren (ontstekingsspanning niet meer toereikend voor een grote elektrodenafstand). Slecht startgedrag.

Oplossing: Nieuwe bougies.

17 Sterke slijtage van de massa-elektrode

Oorzaak: Agressieve brandstof- en olieadditieven. Ongunstige stromingsverhoudingen in de verbrandingskamer, eventueel vanwege aanslag, pingelen van de motor. Geen thermische overbelasting.

Gevolgen: Overslagen van de motor, vooral tijdens het accelereren (ontstekingsspanning niet meer toereikend voor een grote elektrodenafstand). Slecht startgedrag.

Oplossing: Nieuwe bougies.

18 Breken van de isolatorvoet

Oorzaak: Mechanische beschadiging door een klop, een val of door druk op de middenelektrode bij ondeskundige hantering. In grensgevallen kan de isolatorvoet door afzettingen tussen de middenelektrode en de isolatorvoet en door corrosie van de middenelektrode – vooral bij te lange gebruiksduur – springen.

Gevolgen: Afslaan van de motor, de ontstekingsvonk springt op plaatsen over, die niet voldoende door het verse mengsel worden bereikt.

Oplossing: Nieuwe bougies.

A70

Bosch-tip



 Vlakke afdichtzitting

	①	②
M 10 x1	10...15	10...15
M 12 x1,25	15...25	15...20
M 14 x1,25 <13 mm	20...25	15...20
M 14 x1,25 >13 mm	20...40	20...30
M 18 x1,5	30...45	20...35

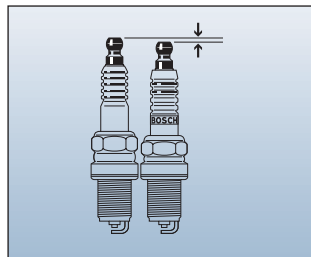
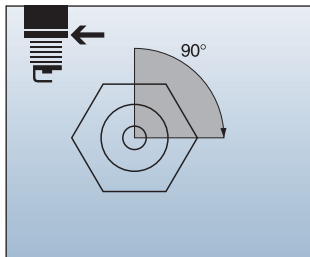

 Kegelvormige afdichtzitting

	①	②
M 14 x1,25	20...40	10...20
M 18 x1,5	30...45	15...23

① in gietijzer
② in lichtmetaal

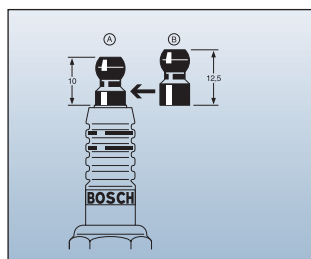
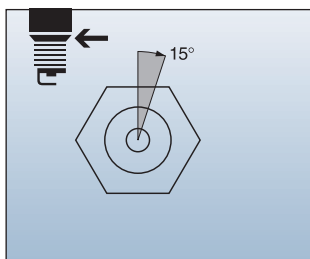
**Correcte inbouw van bougies met momentsleutel:**

Aanhaalmoment (N · m): 10 N · m ≈ 1 kpm

Let op a.u.b.:

De genoemde aanhaalmomenten zijn geldig voor droge, niet gevette en niet geolieerde schroefdraden en voor nieuwe afdichtingen. Indien de schroefdraad gesmeerd is moeten de genoemde aanhaalmomenten met 1/3 worden gereduceerd.

Correcte inbouw van bougies zonder momentsleutel:**Let op a.u.b.:**

De bougie met de hand in de cilinderkop schroeven, tot zij aanligt. Bougies met een vlakke afdichtzitting en een nieuwe afdichting worden vervolgens met de bougiesleutel met ca. 90° verder gedraaid. Bougies met een conische afdichtzitting en bougies met een gebruikte vlakke afdichting worden in dit geval met ca. 15° verder gedraaid. Bougies met massieve afdichtingsring mogen alleen met momentsleutel worden gemonteerd.

Aansluitmoeren voor de bougies**Let op a.u.b.:**

In de motor kunnen bougies ingebouwd zijn, die qua lengte afwijken van de Bosch-bougies.

1. Oude bougies uitschroeven.
2. Met de nieuwe Bosch-bougies vergelijken.
3. Indien de vervangen bougie langer is dan de Bosch-bougie, de opgeschroefde aansluitmoer A vervangen door de bijgesloten langere aansluitmoer B.

Let op!

De aanbevelingen voor de bougies zijn vastgelegd door Bosch, voor zover zij niet afkomstig zijn van de voertuig of motorfabrikant. De aanbevolen bougies gelden voor normale bedrijfsomstandigheden bij seriemodellen, maar niet voor race-, speciale en geavanceerde uitvoeringen, tenzij zulke modellen speciaal worden genoemd.

Het gebruik van andere dan de aanbevolen warmtegraden kan bij bijzondere bedrijfsomstandigheden noodzakelijk worden. Indien geen bougies met de vastgelegde elektrodenafstand ter beschikking staan, moet de elektrodenafstand worden afgesteld. Hiervoor raden wij u het gebruik van de bougievoelmaat van Bosch aan (zie pagina A 71).

Toebehoren

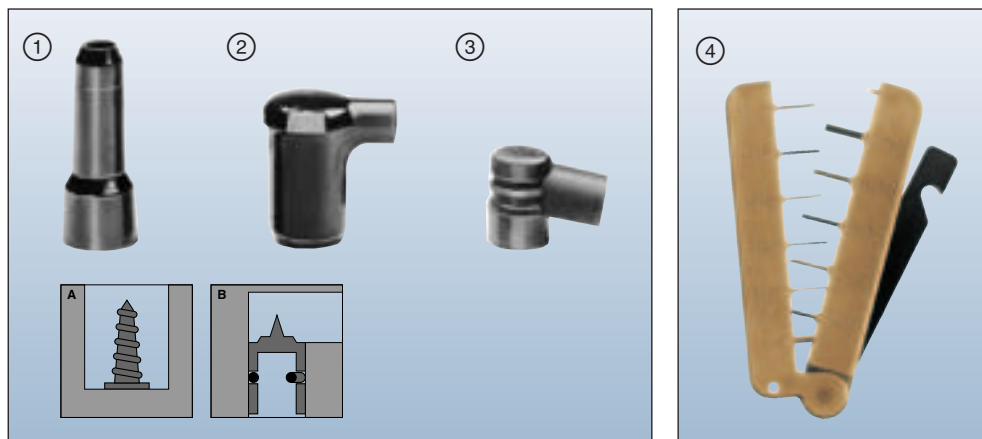

① – ③ Bougiestekker (niet ontstoord)

Aansluiting bougiekabel	Lengte mm	Bougiekabel Ø mm	Opmerkingen	Afb.	Bestelnummer
M4	52	7		① A	0 356 002 001
	39/35 ¹⁾	7		② B	0 356 050 001
waterdicht					
M4	24/30 ¹⁾	5	voor korte bougie	(WK..) ③ A	0 356 050 009
				(WS..) ③ A	0 356 050 010

¹⁾ Bougiezijde/Bougiekabelzijde

④ Bougievoelermaat

voor het controleren en afstellen van de elektrodenafstand

Bestelnummer **0 986 600 000**

Isoleerpasta (zonder afb.)

Kleur: wit

Smeltpunt: 320 °C

Eigenschappen: wasachtig, reukloos, verbetering van de isolerende eigenschappen bij verbindingen aan de secundaire zijde van het ontstekingsstelsel, voorkomen van overslagen bij bougies Toepassing: bougiestekkers, ontstoringstekkers, beschermkappen, verdelerkappen e.d.

EG-veiligheidsinformatieblad: **1 987 123 010**

Tube met 45 ml **1 987 123 010**

Aansluitmoer (zonder afb.)

Voor bougie-aansluitschroefdraad M4. Spuitgietzink, blank, verpakkeseenheid 25 stuks

Lengte 10 mm **1 243 345 023**

Lengte 12,5 mm **1 243 345 025**

Vlakke afdichtring (zonder afb.)

Voor bougies met schroefdraad

M 14 x 1,25 **1 240 280 028**

Typformelförklaring

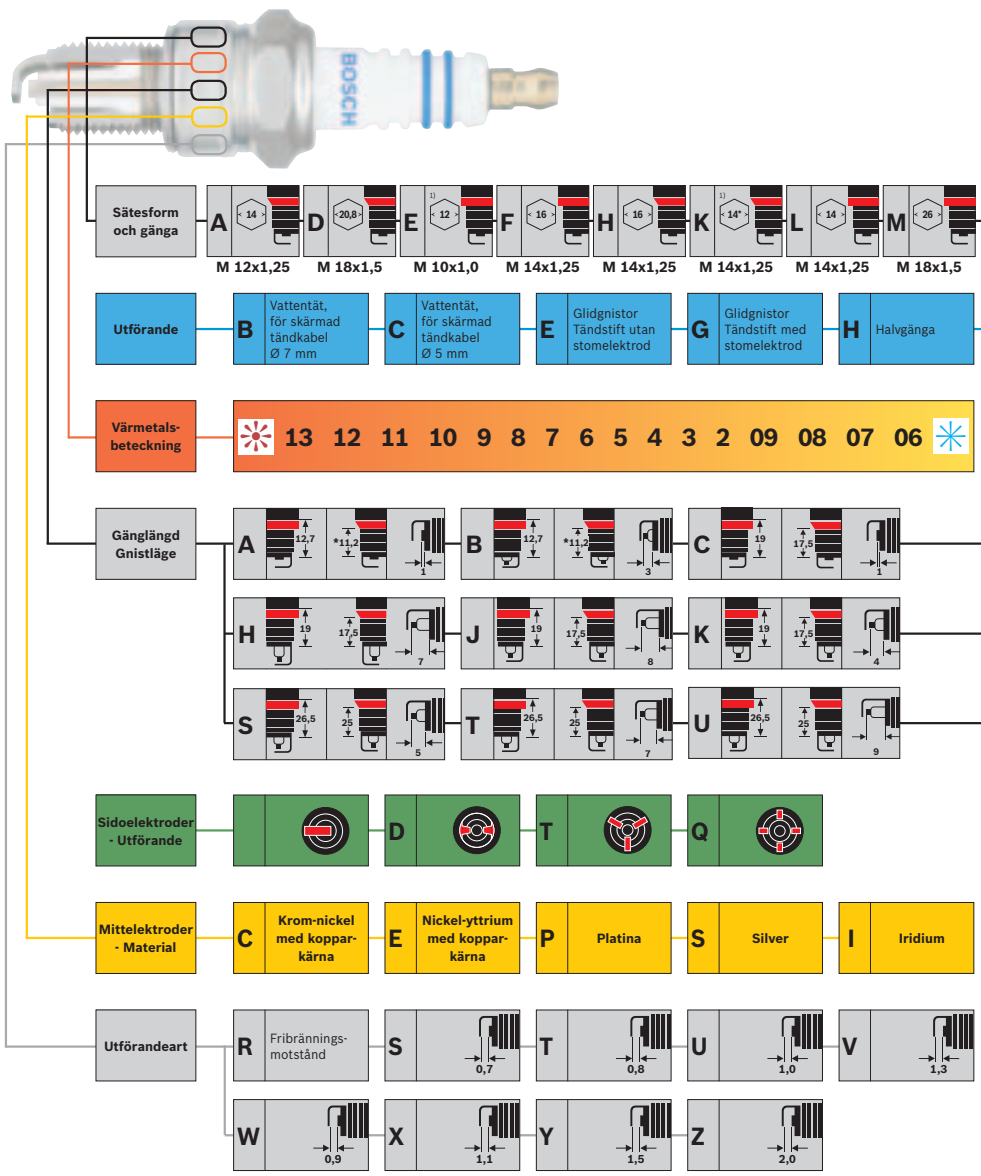

* Gänglängden för tändstift med sätessform D och gnistläge A eller B är 10,9 mm.

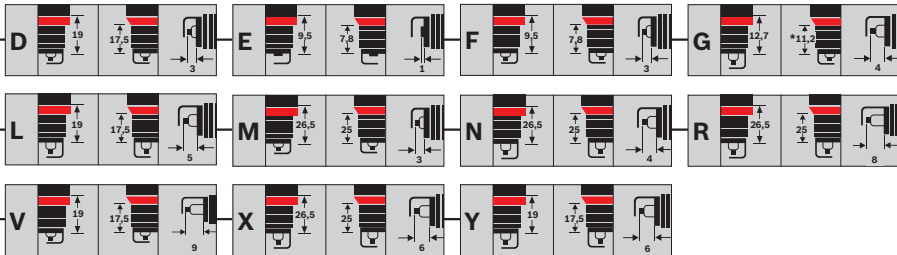
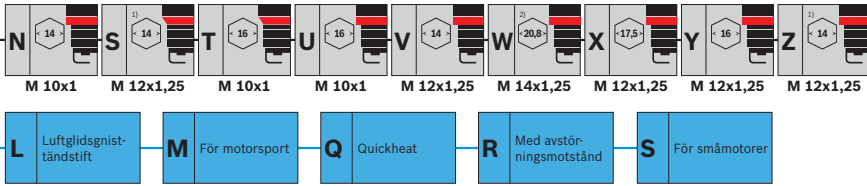

0 Avvikelser från basutförandet							
1 P0-utförande med Ni-stomelektrod							
2 Två-komponentsstomelektrod							
3 Gänga i speciallängd							
4 Förlängd isolatorfot							
9 Special-utförande							
	Mittelektrod med påsvetsad ädelmetall- bricka diameter 0,8 eller 1,1 mm möjlig	Mittelektrod med påsvetsad ädelmetall- stift diameter 0,6 eller 0,8 mm möjlig	Stomelektrod Enkomponents nickel-yttrium	Stomelektrod Tvåkomponents nickel-yttrium	Stomelektrod Enkomponents stomelektrod i nickel- yttrium med laser- legerad ädelmetall- insats	Stomelektrod Tvåkomponents nickel-yttrium med laserlegerad ädelmetallinsats	Stomelektrod Enkom- ponents nickel-yttrium med lasersvetsad ädelmetallstift 0,6 mm i diameter
10	●	—	●	—	—	—	—
15	●	—	●	—	—	—	—
22	●	—	—	—	●	—	—
222	●	—	—	—	—	●	—
23	—	●	—	—	●	—	—
232	—	●	—	—	—	●	—
30	—	●	●	—	—	—	—
302	—	●	—	●	—	—	—
33	—	●	—	—	●	—	—
332	—	●	—	—	—	●	—
35	—	●	—	—	—	—	●

¹⁾ Dubbelsexkant ²⁾ Nyckelvidd 19,0 mm vid småmotorer i utförande WS

A74

Tändstiftens gnistteknik



Takelektrod – mittelektrod (fig. a).
Sidoelektrod – mittelektrod (fig. b).

Tändstift med luftgnistteknik

Tändgnistan slår över raka vägen genom luft-bränsle-blandningen mellan mittelektroden och stomelektroden (fig. a, b, c).

Fördelar:

- ▶ Hög tändsäkerhet under hela livslängden
- ▶ Bra kallstartegenskaper
- ▶ Litet tändspänningsbehov

Profilerad stomelektrod – mittelektrod (fig. c).

De extra skarpa kanterna på insidan som bildas av stomelektrodens profil överför i kombination med det förstorade utrymmet mellan elektroderna lättare och effektivare gnistans värmeenergi till bränsle-luftblandningen (fig. c).

Fördelar:

- ▶ Hög tändsäkerhet tack vare snabbt överslag av tändgnistan och snabb antändning av blandningen
- ▶ Extra kallstartsäkerhet även vid låg elsystemspänning
- ▶ Den förbättrade förbränningen skyddar motorn och speciellt katalysatorn
- ▶ Dessutom reducerad bränsleförbrukning då misständningar elimineras



Sidoelektrod – isolatoryta – mittelektrod

Tändstift med glidnistteknik

Stomelektrodena är så placerade att endast mycket långa och kraftiga luftglidnistor alstras (fig. d).

Fördelar:

- ▶ Ökad tändsäkerhet under hela livslängden
- ▶ Optimalt skydd för katalysatorn
- ▶ Väldigt litet tändspänningsbehov
- ▶ Självrengöring från sotavlagring
- ▶ Ökad användningstid tack vare flera stomelektroder

Sidoelektrod – mittelektrod
eller sidoelektrod – isolatoryta – mittelektrod

Tändstift med luftglidnistteknik

Tändgnistan väljer för säker tändning den bästa vägen från mittelektroden till stomelektroden antingen som luftgnista eller som luftglidnista. Tändgnistan slår vid tändning raka vägen över från mittelektroden till stomelektroden. Luftglidnistan glider över förekommande laddningsbärare på isolatorfotsspetsen och slår som luftgnista över till stomelektroden (fig. e).

Fördelar:

- ▶ Ökad tändsäkerhet under hela livslängden
- ▶ Förbättrade kallstartegenskaper
- ▶ Litet tändspänningsbehov
- ▶ Självrengöring från sotavlagring
- ▶ Optimalt skydd för katalysatorn
- ▶ Ökad användningstid tack vare flera stomelektroder

Tändstiftsutseende



1 + 2 normal

Isolatorfot i gråvit-grågul till rådjursbrun färg. Motorn är i ordning. Värmetalet korrekt valt. Blandningsinställningen och tändinställningen är felfria, inga misständningar, kallstartanordningen fungerar. Inga rester av blyhaltiga bränsletillsatser eller legeringsbestånds-delar från motoroljan. Ingen termisk överbelastning.

3 + 4 sotig

Isolatorfoten, elektrodena och tändstiftshuset är täckta av ett sammetslent, mattsvart sot.

Orsak: Felaktig blandningsinställning (föregasare, insprutning): Blandningen för fet, luftfiltret kraftigt nedsmutsat, startautomatiken inte i ordning eller startkabeln (choken) för länge dragen, till övervägande del kortdistanskörning, tändstiftet för kallt, värmetalsbeteckningen för låg.

Följder: Tändmissar, dåligt kallstartbeteende.

Åtgärd: Ställ korrekt in blandningen och startanordningen, kontrollera luftfiltret.

5 + 6 oljig

Isolatorfoten, elektrodena och tändstiftshuset är täckta av oljeglänsande sot eller oljesot.

Orsak: För mycket olja i förbränningsrummet. För hög oljenivå, kraftigt nedslitna kolringar, cylindrar och ventiltjejder. Vid 2-takts Ottomotorer för mycket olja i blandningen.

Följder: Tändmissar, dåliga startegenskaper.

Åtgärd: Kontrollera motorn, korrigerar bränsle-oljeblandningen, nya tändstift.



7 Ferrocen

Isolatorfoten, elektroderna och delvis tändstiftsstommen är täckta av orangeröda fasthäftande avlagringar.

Orsak: Järnhaltiga bränsleadditiv. Avlagringen uppstår under normal drift efter några få tusen kilometer.

Följder: Den järnhaltiga beläggningen är elektriskt ledande och medför tändmissar.

Åtgärd: Nya tändstift, en rening är meningslös.

8 förblying

Isolatorfoten uppvisar partiellt en brunung eller ibland en grönaktig glasyr.

Orsak: Blyhaltiga bränsletillsatser. Glasyren uppstår vid hög motorbelastning efter en längre körning med dellast.

Följder: Vid högre belastning blir beläggnet elektriskt ledande och medför misständningar.

Åtgärd: Nya tändstift, en rening är meningslös.

9 + 10 kraftig förblying

Isolatorfoten uppvisar partiellt en tjock brunung eller ibland en grönaktig glasyr.

Orsak: Blyhaltiga bränsletillsatser. Glasyren uppstår vid hög motorbelastning efter en längre körning med dellast.

Följder: Vid högre belastning blir beläggnet elektriskt ledande och medför misständningar.

Åtgärd: Nya tändstift, en rening är meningslös.

11 + 12 Askbildning

Kraftig askbeläggning av olje- och bränsletillsatser på isolatorfoten, i andningsrummet (ringspalt) och på stomelektroden. Lös till slaggliknande sammansättning.

Orsak: Legeringsbeståndsdelar speciellt i oljan kan alstra denna aska i förbränningsrummet och på tändstiftet.

Följder: Kan leda till glödtändningar med effektförlust och motorskada.

Åtgärd: Justera motorn. Använd nya tändstift och eventuellt annan olja.

Tändstiftsutseende



13 Nedsmält mittelelektrod

Mittelektroden smält, blåsigt svampartad, uppmjukad isolatorfotspets.

Orsak: Termisk överbelastning till följd av glödtändningar, t.ex. pga för tidigt inställd tändning, förbränningsrester i förbränningsrummet, defekta ventiler, skadade tändfördelare och otillräcklig bränslekaraktär. Eventuellt för lågt värmetal.

Följder: Tändmissar, effektförlust (motorskada).

Åtgärd: Kontrollera motor, tändning och blandningsanrikning. Nya tändstift med korrekt värmetal.

14 Nedsmält mittelelektrod

Mittelelektrod nedsmält, stomelektroden samtidigt angripen.

Orsak: Termisk överbelastning till följd av glödtändningar, t.ex. pga för tidigt inställd tändning, förbränningsrester i förbränningsrummet, defekta ventiler, skadade tändfördelare otillräcklig bränslekaraktär.

Följder: Tändmissar, effektförlust, eventuell motorskada. Isolatorfotspricka till följd av överhettad mittelelektrod möjlig.

Åtgärd: Kontrollera motor, tändning och blandningsanrikning. Nya tändstift.

15 Smält mittelelektrod

Elektroder med blomkålsliknande utseende. Eventuell utfällning av tändstiftsfrämmande material.

Orsak: Termisk överbelastning till följd av glödtändningar, t.ex. pga för tidigt inställd tändning, förbränningsrester i förbränningsrummet, defekta ventiler, skadade tändfördelare och otillräcklig bränslekaraktär.

Följder: Före totalt haveri (motorskada) sjunker effekten.

Åtgärd: Kontrollera motor, tändning och blandningsanrikning. Nya tändstift.



16 Kraftigt nedslitning på mittelelektroden

Orsak: Bytesintervallet för tändstift har ej beaktats.

Följder: Tändmissar, speciellt vid acceleration (tändspänningen räcker inte längre till för det stora elektrodavståndet). Dåliga startegenskaper.

Åtgärd: Nya tändstift.

17 Kraftigt nedsliten stomelektrod

Orsak: Aggressiva bränsle- och oljetillsatser. Ogynnsamma strömningsförhållanden i förbränningsrummet, eventuellt till följd av avlagringar, motorknackning. Ingen termisk överbelastning.

Följder: Tändmissar, speciellt vid acceleration (tändspänningen räcker inte längre till för det stora elektrodavståndet). Dåliga startegenskaper.

Åtgärd: Nya tändstift.

18 Isolatorfotbrott

Orsak: Mekaniska skador genom slag, fall eller tryck på mittelelektroden vid osaklig hantering. I gränsfall till följd av avlagringar mellan mittelelektroden och isolatorfoten och korrosion på mittelelektroden isolatorfoten sprängas – speciellt vid mycket lång drifttid.

Följder: Tändmissar, tändgnistan slår över på ställen som inte har tillgång till en frisk bränsleblandning.

Åtgärd: Nya tändstift.

Bosch tips



Plantätningssäte

	①	②
M 10 x1	10...15	10...15
M 12 x1,25	15...25	15...20
M 14 x1,25 <13 mm	20...25	15...20
M 14 x1,25 >13 mm	20...40	20...30
M 18 x1,5	30...45	20...35

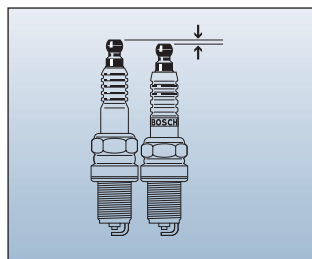
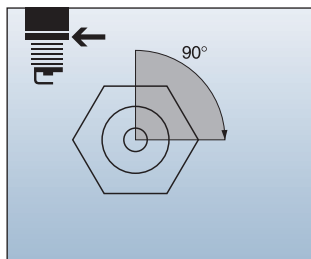

Kontätningssäte

	①	②
M 14 x1,25	20...40	10...20
M 18 x1,5	30...45	15...23

① i gjutjärn
② i lättmetall

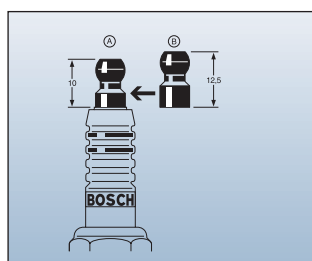
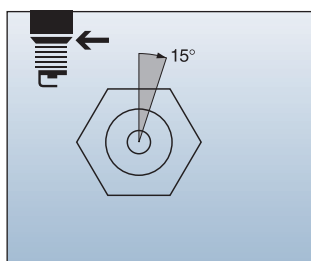

Korrekt tändstiftsmontering med momentnyckel:

Åtdragningsmoment (N • m):
10 N • m ≈ 1 kpm

Beakta:

Angivna åtdragningsmoment gäller för torra, icke med fett eller olja smorda gängor och för nya packningar. Vid smord gänga skall de angivna åtdragningsmomenten reduceras med en 1/3.

Korrekt tändstiftsmontering utan momentnyckel:

Beakta:

Skruva för hand stadigt in tändstiftet i cylinderlocket. Nya tändstift med planpackningssäte och ny packning dras sedan med tändstiftsnyckeln fast ytterligare ca 90°. Tändstift med koniskt tätningssäte och tändstift med använd planpackning dras sedan fast ytterligare ca 15°. Tändstift med massiv packning får endast monteras med hjälp av en momentnyckel.

Tändstiftens anslutningsmutter

Beakta:

I motorn kan tändstift vara monterade som i längd avviker från Boschs tändstift.

1. Skruva bort det gamla tändstiftet
2. Jämför med det nya Bosch tändstiftet
3. Om det borttagna tändstiftet är längre än Boschs tändstift skall den påskruvade anslutningsmuttern A bytas ut mot medföljande längre anslutningsmutter B.

Beakta!

Bosch har fastslagit rekommendationer för alla tändstift med undantag för de de som bileller motortillverkaren levererat. De rekommenderade tändstiften gäller för normala körförhållanden på seriemodeller, dock inte för racer-, special- och högeffekt-sutföranden, om inte dessa modeller särskilt angivits.

Vid vissa körförhållanden kan det vara nödvändigt att använda andra värmetal än de som rekommenderats. Om tändstift med föreskrivet elektroavstånd inte finns tillgängligt, måste elektroavståndet justeras. För justering rekommenderas Boschs tändstiftstolk (se sida A 81).

Tillbehör

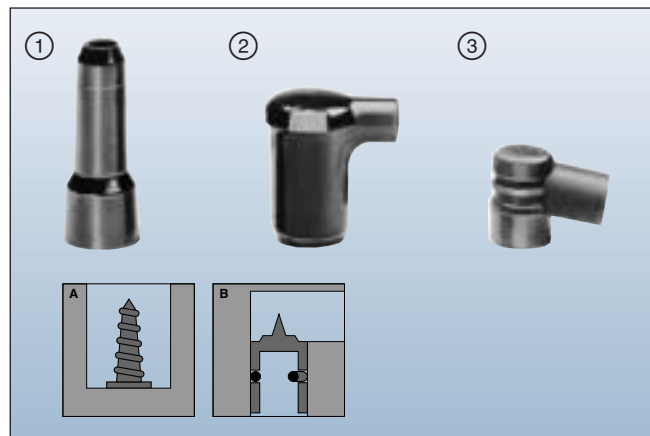

① – ③ Tändstiftskontakt (inte avstörd)

Anslutning tändstift	Längd mm	Tändkabel Ø mm	Kommentarer	Fig.	Artikelnummer
M4	52	7		① A	0 356 002 001
	39/35 ¹⁾	7		② B	0 356 050 001
vattentät					
M4	24/30 ¹⁾	5	för tändstift i kort utförande	③ A (WK..)	0 356 050 009
				③ A (WS..)	0 356 050 010

¹⁾ Tändstiftssida/tändkabelssida

④ Tändstiftstolk

för kontroll och justering av elektrodavståndet

Artikelnummer **0 986 600 000**

Isolerpasta (utan fig.)

Färg: vit

Smältpunkt: 320°C

Egenskaper: Vaxartad, luktlös, förbättrade isoleregenskaper på tändsystemets sekundärsidiga förbindelser, förhindrar huvudöverslag på tändstifts Användning: Tändstiftskontakt, avstörningskontakt, skyddskapslar, fördelarlock o. dyl.

EG-säkerhetsdatablad: **1 987 123 010**

45-ml tub **1 987 123 010**

Anslutningsmutter (utan bild)

För tändstift med anslutningsgänga M4.

Zinkpressgjutgods, blankt, förpackning om 25 st

Längd 10 mm **1 243 345 023**

Längd 12,5 mm **1 243 345 025**

Planpackning (utan bild)

För tändstift med inskruvningsgänga

M 14 x 1,25 **1 240 280 028**

Vysvětlení typového označení

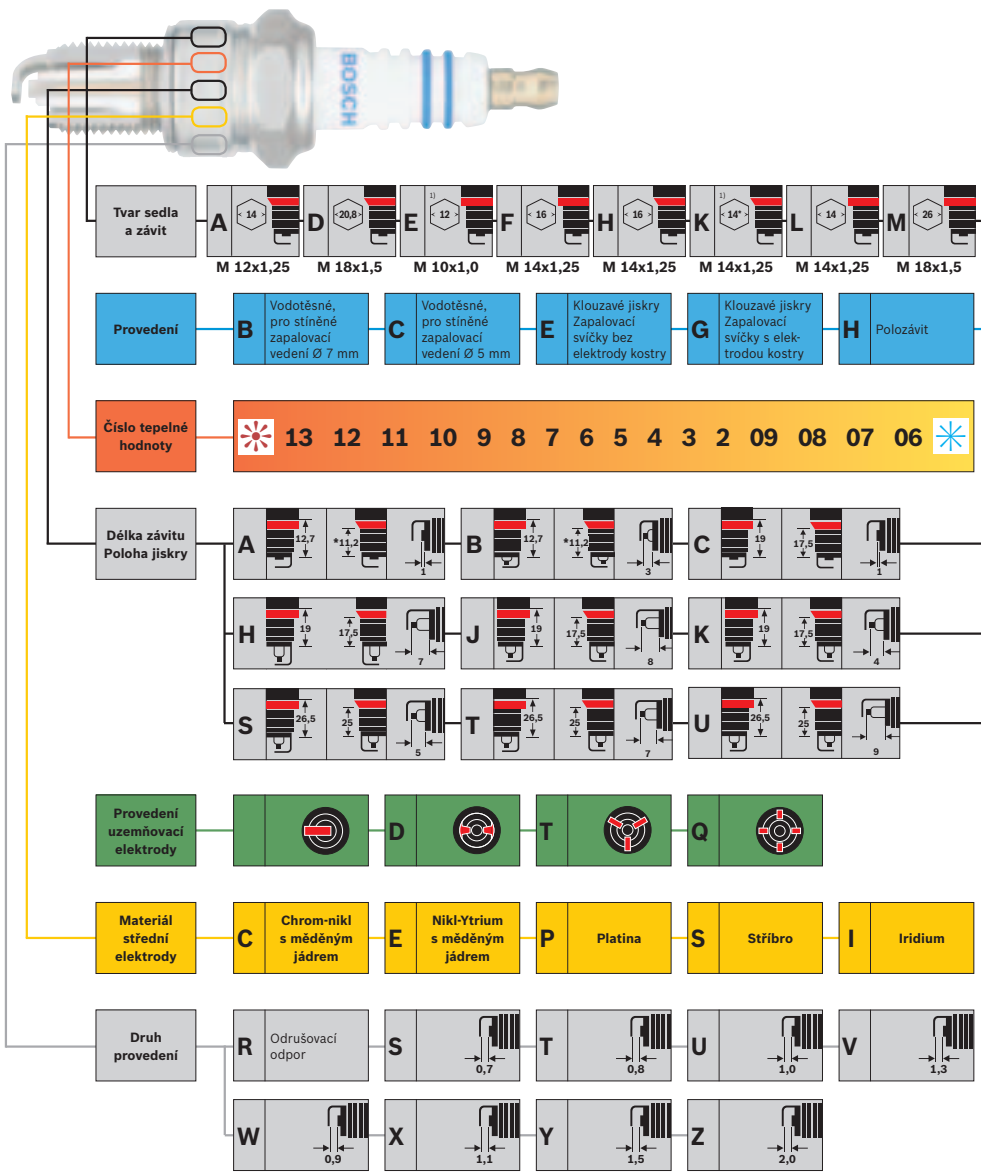

* Délka závitů pro zapalovací svíčky s tvarem sedla D a polohou jiskry A nebo B je 10,9 mm

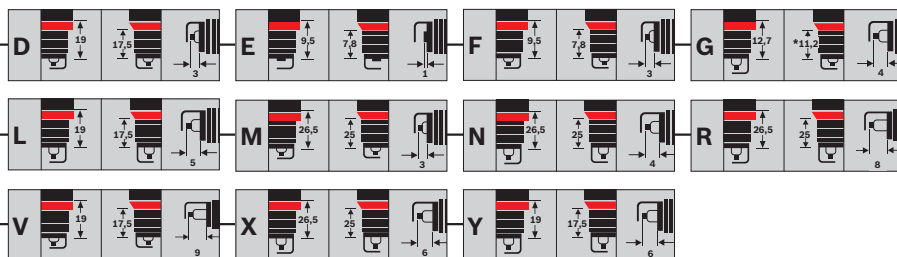
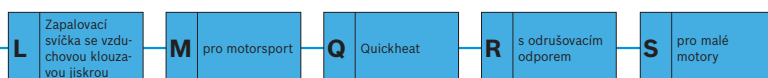
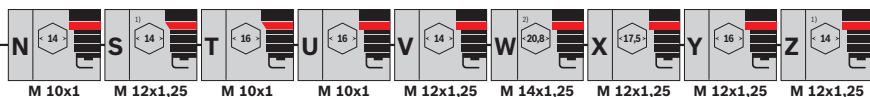

0 Odchyly od základního provedení

1 Provedení PO s kostičkou elektrodou z Ni

2 Kostička elektrody ze dvou materiálů

3 Závit speciální délky

4 Prodloužená patka izolátoru

9 Speciální provedení

	Střední elektroda s navařenou ušlechtilý kov destičkou Je možný průměr 0,8 nebo 1,1 mm	Střední elektroda s možným navařeným ušlechtilým kovem kolečkem o průměru 0,6 nebo 0,8 mm	Elektroda kostry Jednosložková nikl-yttrium	Elektroda kostry Dvosložková nikl-yttrium	Elektroda kostry Jednosložková nikl-yttrium s laserem legovanou ušlechtilý kov vrstvou	Elektroda kostry Dvosložková nikl-yttrium s laserem legovanou ušlechtilý kov vrstvou	Elektroda kostry Jednosložková nikl-yttrium s laserem svářeným kolečkem z ušlechtilého kovu s R 0,6 mm
10	●	—	●	—	—	—	—
15	●	—	●	—	—	—	—
22	●	—	—	—	●	—	—
222	●	—	—	—	—	●	—
23	—	●	—	—	●	—	—
232	—	●	—	—	—	●	—
30	—	●	●	—	—	—	—
302	—	●	—	●	—	—	—
33	—	●	—	—	●	—	—
332	—	●	—	—	—	●	—
35	—	●	—	—	—	—	●

1) Dvojitý šestihran 2) Otvor klíče 19,0 mm u provedení pro malé motory WS

Zapalovací svíčky – technologie jisker



Střešová elektroda – střední elektroda (obr. a).

Boční elektroda – střední elektroda (obr. b).

Zapalovací svíčky s technologií vzduchových jisker

Vzduchové jiskry prorážejí přímou cestou mezi střední elektrodou a elektrodou kostry směs paliva se vzduchem, která se nachází mezi elektrodami (obr. a, b, c).

Výhody:

- ▶ Vysoká jistota zážehu po celou dobu využitelnosti
- ▶ Dobré chování při studených startech
- ▶ Menší požadavky na zapalovací napětí

Profilovaná elektroda kostry – střední elektroda (obr. c).

Vnitřní, navíc ještě naostřené hrany, které tvoří profil elektrody kostry, slouží ve spojení se zvětšeným prostorem mezi elektrodami ke snadnějšímu, a také účinnějšímu přenosu tepelné energie jiskry na směs paliva se vzduchem (obr. c).

Výhody:

- ▶ Vysoká jistota zážehu v důsledku rychlejšího přeskoky jiskry a vznícení směsi
- ▶ Navíc jistota při studených startech i při nízkém palubním napětí
- ▶ Lepší spalování chrání motor a zejména katalyzátor
- ▶ Navíc snížená spotřeba paliva v důsledku vyloučení vynechávání zážehů



Boční elektroda – povrch izolátoru – střední elektroda

Boční elektroda – střední elektroda
nebo boční elektroda – povrch izolátoru – střední elektroda

Zapalovací svíčky s technologií klouzavých jisker

Elektrody kostry jsou konstrukčně provedeny tak, aby mohly vytvářet výhradně zvláště dlouhé a silné vzduchové jiskry (obr. d).

Výhody:

- ▶ Zvýšená jistota zážehu po celou dobu využitelnosti
- ▶ Optimální ochrana katalyzátoru
- ▶ Zvláště nízké požadavky na zapalovací napětí
- ▶ Samočisticí účinek při usazování sazí
- ▶ Zvýšená doba využitelnosti v důsledku použití více elektrod kostry

Zapalovací svíčky s technologií vzduchových klouzavých jisker

Zapalovací jiskry volí pro bezpečnější zapálení nejlepší cestu od střední elektrody k elektrodě kostry, a to buď jako vzduchová jiskra nebo jako vzduchová klouzavá jiskra. Vzduchová jiskra při zapálení přeskakuje přímou cestou od střední elektrody ke kostřící elektrodě. Vzduchová klouzavá jiskra klouže po existujícím nosiči náboje na hrot patky izolátoru a přeskakuje jako vzduchová jiskra na kostřící elektrodu (obr. e).

Výhody:

- ▶ Zvýšená jistota zážehu po celou dobu užívání
- ▶ Zlepšené chování při studených startech
- ▶ Potřeba menšího zapalovacího napětí
- ▶ Samočisticí účinek při usazování sazí
- ▶ Optimální ochrana katalyzátoru
- ▶ Uspořádání více kostřících elektrod prodlužuje dobu použitelnosti.

Vzhled zapalovacích svíček



1 + 2 Normální

Patka izolátoru má barvu od šedobílě-šedožluté až po světlehnědou. Motor je v pořádku. Je zvolena správná tepelná hodnota. Složení směsi a nastavení zapalování jsou v pořádku, nevyskytuje se vynechávání zážehů, jednotka pro studený start funguje. Žádné zbytky přísad paliva obsahující olovo nebo složky legur z motorového oleje. Nedochozí k tepelnému přetížení.

3 + 4 Znečištění sazemí

Patka izolátoru, elektrody a těleso zapalovací svíčky jsou pokryty sametovými, matnými sazemí.

Příčina: nesprávné složení směsi (karburátor, vstříkávání). Směs je příliš bohatá, vzduchový filtr je silně znečištěn, startovací automatika nebo vstříkovací systém není v pořádku, jízdy převážně ná krátkých trasách, zapalovací svíčky jsou příliš studené, označení tepelné hodnoty je příliš nízké.

Důsledek: vynechávání zážehů, špatné studené starty a chování motoru za studena.

Opatření: zajistit správné složení směsi, seřízení systému (karburátor, vstříkávání), kontrola vzduchového filtru.

5 + 6 Zaolejováno

Patka izolátoru, elektrody a těleso svíčky jsou pokryty lesklým povlakem sazí nebo olejového karbonu.

Příčina: Příliš mnoho oleje ve spalovacím prostoru. Hladina oleje je příliš vysoká, silně opotřebované pístní kroužky, válec a vedení ventilů.

U dvoutaktních benzinových motorů příliš mnoho oleje ve směsi.

Důsledek: Vynechávání zážehů, špatné chování při startu.

Opatření: Provést revizi motoru, upravit na správnou směs paliva a oleje, nové zapalovací svíčky.



7 Ferrocen

Patka izolátoru, elektrody a z části těleso zapalovací svíčky jsou pokryty oranžově červeným povlakem.

Příčina: aditiva pro palivo obsahující železo. Povlak se vytvoří za normálního provozu po několika tisících kilometrech.

Důsledek: Povlak obsahující železo je elektricky vodivý a vyvolává vynechávání zážehů.

Opatření: Nové zapalovací svíčky, čištění je neúčinné.

8 Zanesení olovem

Patka izolátoru místy vykazuje hnědožlutou sklovinu, která může přecházet až do zelené.

Příčina: Přísady do paliva s obsahem olova. Sklovina vzniká při vysokém zatížení motoru po dlouhém provozu při částečném zatížení.

Důsledek: Při vyšším zatížení se povlak stane elektricky vodivým a vyvolává vynechávání zážehů.

Opatření: Nové zapalovací svíčky, čištění je bezúčelné.

9 + 10 Silné zanesení olovem

Patka izolátoru vykazuje místní hnědožlutou sklovinu, která může přecházet až do zelené.

Příčina: Přísady do paliva s obsahem olova. Sklovina vzniká při vysokém zatížení motoru po dlouhém provozu při částečném zatížení.

Důsledek: Při vyšším zatížení se povlak stane elektricky vodivým a vyvolává vynechávání zážehů.

Opatření: Nové zapalovací svíčky, čištění je bezúčelné.

11 + 12 Tvoření popela

Silný povlak popela z přísad oleje a paliva na patce izolátoru i kompenzačním prostoru (kruhové vybrání) na kostřičí elektrodě. Uvolněný až struskovitý povlak.

Příčina: Složky legur pocházející zejména z oleje mohou tento popel zanechat ve spalovacím prostoru a na exponované části svíčky.

Důsledek: Může vést k samozápalům, ztrátě výkonu a k poškození motoru.

Opatření: Odstraňte závady na motoru. Použijte nové zapalovací svíčky, případně jiný olej.

Wygląd świec zapłonowych



13



14



15

13 Natavená střední elektroda

Střední elektroda natavena, bublinatý, houbovitý, změkklý hrot patky izolátoru.

Příčina: Tepelné přetížení v důsledku samozápalů, např. v důsledku předčasného nastavení zážehu, nesprávného průběhu spalování ve spalovacím prostoru, vadných ventilů, poškozeného rozdělovače zapalování a nedostatečné kvality paliva. Případně příliš nízká tepelná hodnota zapalovací svíčky.

Důsledek: Vynechávání zážehů, ztráta výkonu (poškození motoru).

Opatření: Zkontrolujte motor, zapalování a přípravu směsi.

Nové zapalovací svíčky se správnou tepelnou hodnotou.

14 Natavená střední elektroda

Střední elektroda je odtavená, současně je silně narušena také elektroda kostry.

Příčina: tepelné přetížení v důsledků samozápalů, např. díky špatnému nastavení předstihu zapalování (předčasný zážeh), vadným ventilům, poškozenému rozdělovači, nebo špatné kvalitě paliva.

Důsledek: Vynechávání zážehů, ztráta výkonu, případně poškození motoru. Je možné prasknutí patky izolátoru v důsledku přehřáté střední elektrody.

Opatření: Zkontrolujte motor, zapalování a přípravu směsi.

Nové zapalovací svíčky.

15 Natavená střední elektroda

Květákovitý vzhled elektrod. Případně Povlak z materiálů nepocházejících ze svíčky.

Příčina: tepelné přetížení v důsledků samozápalů, např. díky špatnému nastavení předstihu zapalování (předčasný zážeh), vadným ventilům, poškozenému rozdělovači, nebo špatné kvalitě paliva.

Důsledek: Před úplným výpadkem (poškození motoru) dochází ke ztrátě výkonu.

Opatření: Zkontrolujte motor, zapalování a přípravu směsi.

Nové zapalovací svíčky.



16 Silné opotřebení střední elektrody

Příčina: Nebyl dodržen interval výměny svíček.

Důsledek: Vynechávání zážehů, zvláště při zrychlování (zapalovací napětí není při velké vzdálenosti elektrod dostatečné).

Špatné chování při startování.

Opatření: Nové zapalovací svíčky.



17 Silné opotřebení elektrody kostry

Příčina: Agresivní přísady paliva nebo oleje. Nedostatečné podmínky proudění ve spalovacím prostoru případně důsledek usazenin, klepání motoru. Nedochází k tepelnému přetížení.

Důsledek: Vynechávání zážehů, zvláště při zrychlování (zapalovací napětí není při velké vzdálenosti elektrod dostatečné).

Špatné chování při startování.

Opatření: Nové zapalovací svíčky.



18 Prasknutí patky izolátoru

Příčina: mechanické poškození v důsledku úderu, pádu, nebo nadměrného tlaku na střední elektrodu při nesprávném zacházení. V mezních případech může být v důsledku usazenin mezi střední elektrodou a patkou izolátoru, respektive korozi střední elektrody patka izolátoru roztržena – zejména při nadměrné době provozu.

Důsledek: Vynechávání zážehů, přeskokování jisker na místech, kam se čerstvá směs nemůže dostat.

Opatření: Nové zapalovací svíčky.



Bosch tip



Ploché těsnící sedlo

	①	②
M 10 x1	10...15	10...15
M 12 x1,25	15...25	15...20
M 14 x1,25 <13 mm	20...25	15...20
M 14 x1,25 >13 mm	20...40	20...30
M 18 x1,5	30...45	20...35

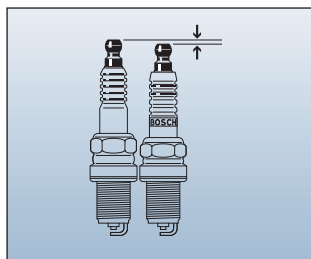
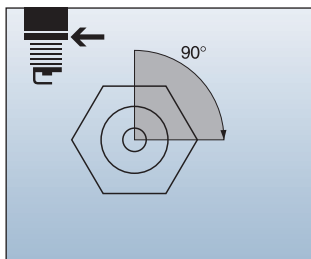

Kuželové těsnící sedlo

	①	②
M 14 x1,25	20...40	10...20
M 18 x1,5	30...45	15...23

① v litině
② v lehkém kovu

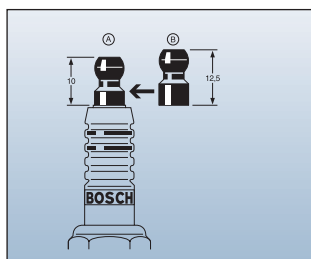
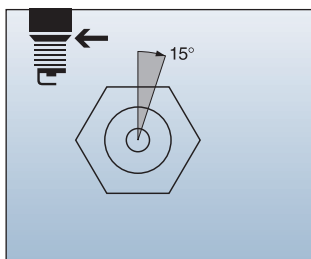

Správná montáž zapalovací svíčky s použitím momentového klíče:

Utahovací moment (N · m):
10 N · m ≈ 1 kpm

Dodržujte:

Uvedené utahovací momenty platí pro suché závity, neošetřené tukem nebo olejem a pro nové těsnící kroužky.

U namazaného závitu je nutné zadané utahovací momenty snížit o 1/3.

Správná montáž zapalovací svíčky bez použití momentového klíče:

Dodržujte:

Zapalovací svíčku našroubujte rukou až dosedne na hlavu válcu. Zapalovací svíčky s plochým těsnícím sedlem a s novým těsněním je potom nutno pootočit klíčem na svíčky o dalších cca 90°. Zapalovací svíčky s kuželovým těsnícím sedlem a s opotřebovaným plochým těsnícím kroužkem je potom nutno pootočit o dalších cca 15°. Zapalovací svíčky s masivním těsnícím kroužkem se smí montovat jen pomocí momentového klíče. Zapalovací svíčky s masivním těsnícím kroužkem se smí montovat jen pomocí momentového klíče.

Připojovací matice zapalovacích svíček

Dodržujte:

V motoru mohou být zamontovány zapalovací svíčky, které se svou délkou odlišují od zapalovacích svíček Bosch.

1. Vyšroubujte původní zapalovací svíčky.
2. Porovnejte je s novými zapalovacími svíčkami Bosch.
3. Pokud je vyměňovaná zapalovací svíčka delší než zapalovací svíčka Bosch, je třeba nahradit našroubovanou připojovací maticí A příloženou delší připojovací maticí B.

Pozor!

Doporučení svíček, pokud nepocházejí od výrobce vozidla nebo motoru, jsou stanovena společností Bosch. Doporučení zapalovacích svíček platí pro normální provozní podmínky u sériových modelů, nikoli však pro závodní, speciální a vysoce výkonná provedení, pokud nejsou tyto modely zvláště uvedeny.

Použití jiných než doporučených tepelných hodnot může být nutné v důsledku zvláštních provozních podmínek. V případě, že nejsou k dispozici zapalovací svíčky s předepsanou vzdáleností elektrod, je nutno vzdálenost elektrod seřídit. K tomu doporučujeme použít měřek na zapalovací svíčky Bosch (viz str. A 91).

Příslušenství

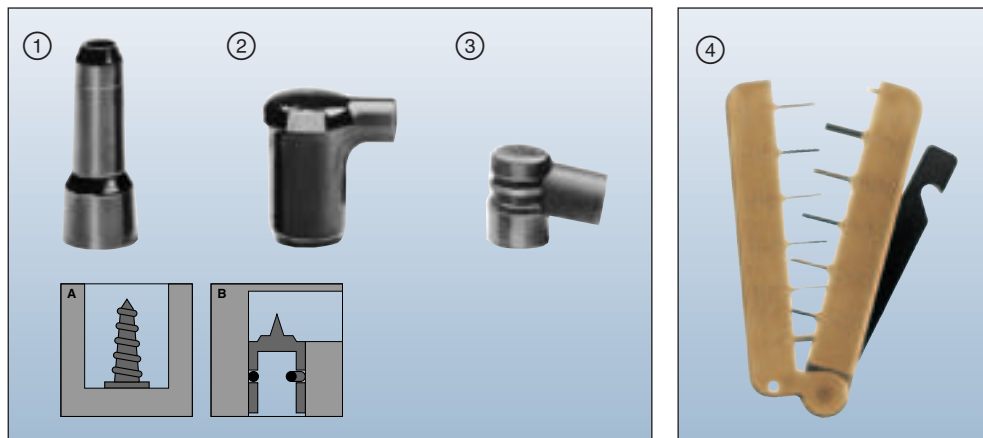

① – ③ Koncovka zapalovací svíčky (neodrušená)

Připojení zapalovací svíčky	Dlouho mm	Zapalovací vedení Ø mm	Poznámky	Obr.	Objednací číslo
M4	52	7		① A	0 356 002 001
	39/35 ¹⁾	7		② B	0 356 050 001
vodotěsný					
M4	24/30 ¹⁾	5	pro zapalovací svíčky (WK..)	③ A	0 356 050 009
			krátké konstrukce (WS..)	③ A	0 356 050 010

¹⁾ Strana zapalovací svíčky/Strana zapalovacího kabelu

④ Měrka pro zapalovací svíčky

ke kontrole a seřízení vzdálenosti elektrod

Objednací číslo **0 986 600 000**

Izolační pasta (bez obrázku)

Barva: bílá

Bod tání: 320 °C

Vlastnosti: voskový, bez zápachu, zlepšení izolačních vlastností propojení na sekundární straně zapalovací soustavy, zabraňuje přeskokům na zapalovací svíčky

Použití: Koncovka zapalovací svíčky, odrušovací koncovka, ochranná víčka, víčka rozdělovače apod.

Bezpečnostní list s údaji EU: **1 987 123 010**

Tuba 45 ml **1 987 123 010**

Připojovací matice (bez obrázku)

Pro připojovací závit zapalovacích svíček M4.

Zinkový tlakový odlitek, lesklá, baleno po 25 kusech

Délka 10 mm **1 243 345 023**

Délka 12,5 mm **1 243 345 025**

UPloché těsnící kroužek (bez obrázku)

Pro zapalovací svíčky s našroubovatelným závitem

M 14 x 1,25 **1 240 280 028**

Расшифровка маркировки свечи зажигания

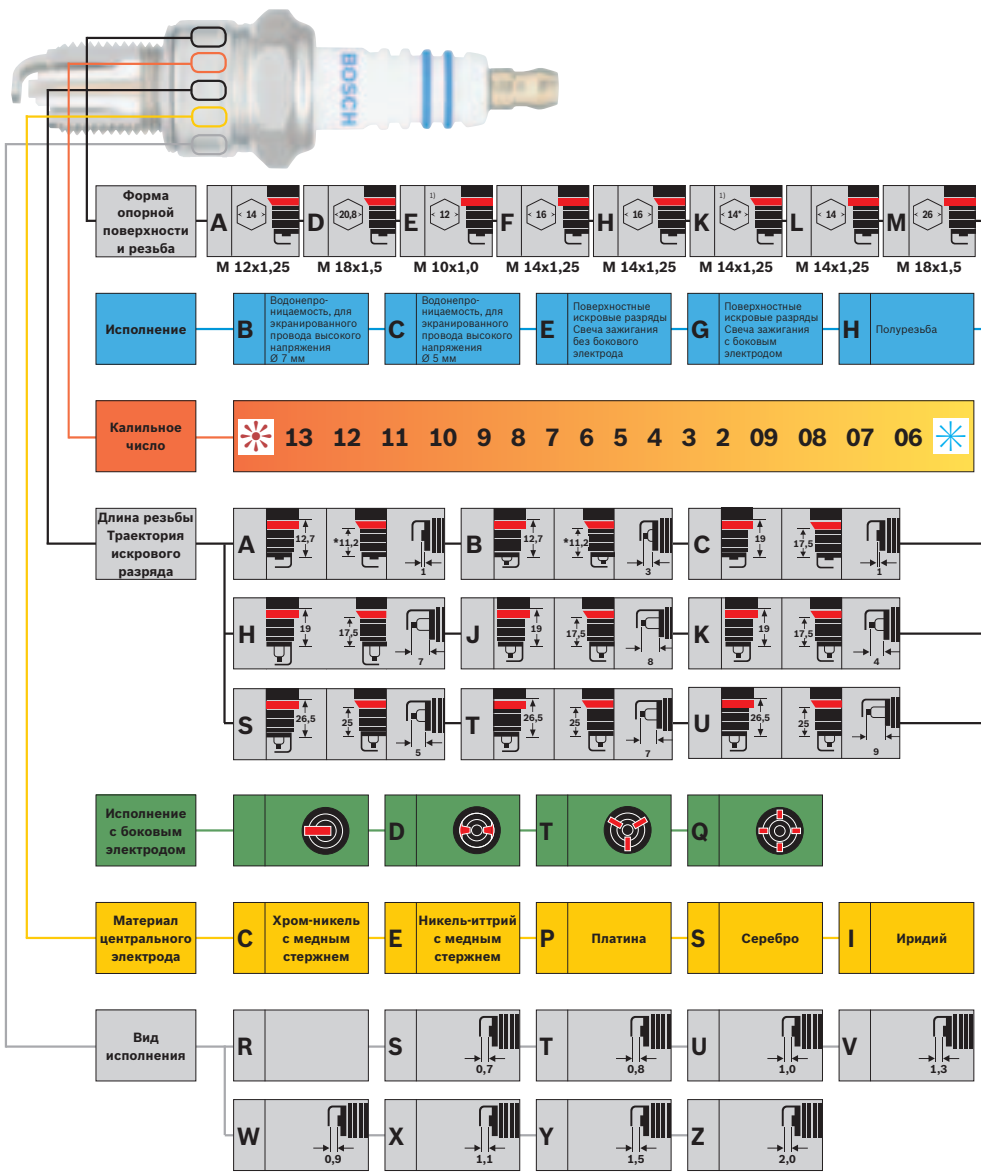

* Длина резьбы для свечей зажигания с формой опорной поверхности D и траекторией искрового разряда A или B составляет 10,9 мм

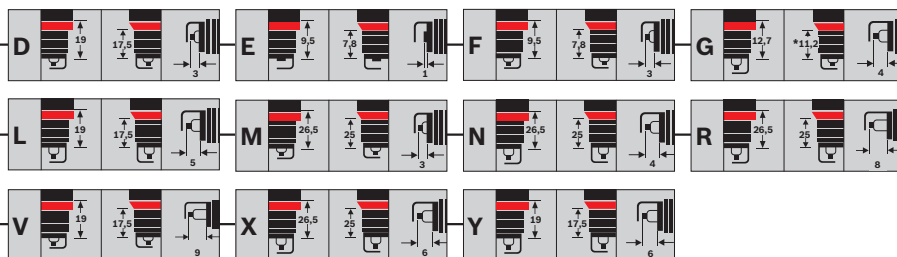
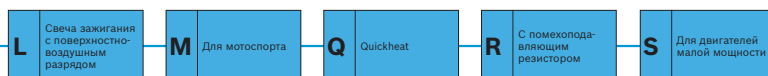
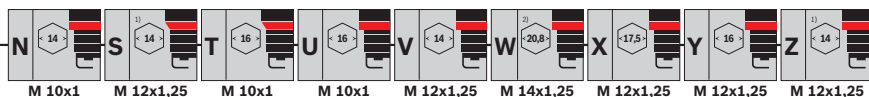

0 Отклонения от базового исполнения

1 Исполнение P0 с никелевым боковым электродом

2 Боковой двухкомпонентный электрод

3 Резьба специальной длины

4 Удлиненный тепловой конус изолятора

9 Специальное исполнение

	Центральный электрод с наваренной благородный металл пластинкой Возможен диаметр 0,8 или 1,1 мм	Центральный электрод с наваренным благородный металл стержнем и возможным диаметром 0,6 или 0,8 мм	Боковой электрод Однокомпонентный, никель-иттрий	Боковой электрод Двухкомпонентный, никель-иттрий	Боковой электрод Однокомпонентный, никель-иттрий, лазерное легирование с Благородный металл вставкой	Боковой электрод Двухкомпонентный, никель-иттрий, лазерное легирование с Благородный металл вставкой	Боковой однокомпонентный электрод, никель-иттрий, с приваренным лазером стержнем из благородного металла диаметром 0,6 мм
10	●	-	●	-	-	-	-
15	●	-	●	-	-	-	-
22	●	-	-	-	●	-	-
222	●	-	-	-	-	●	-
23	-	●	-	-	●	-	-
232	-	●	-	-	-	●	-
30	-	-	●	-	-	-	-
302	-	●	-	●	-	-	-
33	-	●	-	-	●	-	-
332	-	-	-	-	-	●	-
35	-	●	-	-	-	-	●

1) Двойной шестигранник 2) Размер ключа 19,0 мм для двигателей малой мощности исполнения WS

Технология искрового разряда свечи зажигания



Верхний электрод – Центральный электрод (рис. а).
Боковой электрод – Центральный электрод (рис. b).

Свечи зажигания с воздушным искровым разрядом

Воспламеняющая искра напрямую пробивает топливо-воздушную смесь, находящуюся между центральным и боковым электродами (рис. а, b, с).

Преимущества:

- ▶ Высокая надежность зажигания на протяжении всего срока службы
- ▶ Хорошие пусковые качества
- ▶ Небольшое пробивное напряжение

Профилированный боковой электрод – Центральный электрод (рис. с).

Дополнительные внутренние острые края, образуемые за счет профиля бокового электрода, вместе с увеличенным пространством между электродами обеспечивают более легкую и более эффективную передачу тепловой энергии искры в топливо-воздушную смесь (рис. с).

Преимущества:

- ▶ Высокая надежность зажигания благодаря быстрому проскакиванию искры и воспламенению смеси
- ▶ Дополнительная надежность пуска холодного двигателя даже при низком бортовом напряжении
- ▶ надежная защита двигателя и катализатора
- ▶ Дополнительное снижение расхода топлива за счет предотвращения перебоев в зажигании



Боковой электрод – Поверхность изолятора –
Центральный электрод

Свечи зажигания с поверхностным искровым разрядом

Боковые электроды расположены таким образом, чтобы образовывались наиболее длинные и мощные поверхностно-воздушные искровые разряды (рис. d).

Преимущества:

- ▶ Повышенная надежность зажигания на протяжении всего срока службы
- ▶ Оптимальная защита катализатора
- ▶ Особо низкое пробивное напряжение
- ▶ Самоочистление при образовании нагара
- ▶ Повышенный срок службы благодаря нескольким боковым электродам

Боковой электрод – Центральный или боковой электрод –
Поверхность изолятора – Центральный электрод

Свечи зажигания с поверхностно-воздушным искровым разрядом

Искра ищет наилучший для надежного зажигания путь от центрального электрода к боковому электроду для воздушного или для поверхностно-воздушного разряда. При зажигании воздушный искровой разряд проскакивает напрямую от центрального электрода к боковому. Поверхностно-воздушный искровой разряд скользит по имеющемуся на вершине теплового конуса изолятора носителю заряда и, как и воздушный искровой разряд (рис е).

Преимущества:

- ▶ Повышенная надежность зажигания на протяжении всего срока службы
- ▶ Улучшенные пусковые качества холодного двигателя
- ▶ Незначительное пробивное напряжение
- ▶ Самоочистление при образовании нагара
- ▶ Оптимальная защита катализатора
- ▶ повышенный срок службы благодаря нескольким боковым электродам



7 Ферроцен

Тепловой конус изолятора, электроды и, частично, корпус свечи зажигания покрыты оранжевыми, крепко прилипшими отложениями.

Причина: Железосодержащие присадки к топливу. При нормальной эксплуатации отложение образуется через несколько тысяч километров.

Последствия: Железосодержащий налет проводит ток и вызывает пропуски искрообразования.

Устранение: Заменить свечи зажигания, очистка бесполезна.

8 Отложение свинца

На тепловом конусе изолятора местами имеется желто-коричневая глазурь, которая может переходить в зеленоватый цвет.

Причина: Присадки к топливу с содержанием свинца. Глазурь образуется при высокой нагрузке двигателя после длительной работы в режиме частичной нагрузки.

Последствия: При высокой нагрузке налет становится токопроводящим и вызывает пропуски искрообразования.

Устранение: Заменить свечи зажигания, очистка бесполезна.

9 + 10 Сильное отложение свинца

На тепловом конусе изолятора местами имеется толстая желто-коричневая глазурь, которая может переходить в зеленоватый цвет.

Причина: Присадки к топливу с содержанием свинца. Глазурь образуется при высокой нагрузке двигателя после длительной работы в режиме частичной нагрузки.

Последствия: При высокой нагрузке налет становится токопроводящим и вызывает пропуски искрообразования.

Устранение: Заменить свечи зажигания, очистка бесполезна.

11 + 12 Образование золы

Сильный налет золы из присадок к маслу и топливу на тепловом конусе изолятора, в полости, доступной для рабочей смеси (кольцевом зазоре) и на боковом электроде. Рыхлая или шлакообразная структура.

Причина: Легирующие компоненты, особенно из масла, могут оставить эту золу в камере сгорания и на тепловом конусе изолятора.

Последствия: Это может привести к калильному зажиганию с потерей мощности и поломке двигателя.

Устранение: Отремонтировать двигатель. Заменить свечи зажигания, возможно, залить другое масло.

Внешний вид теплового конуса

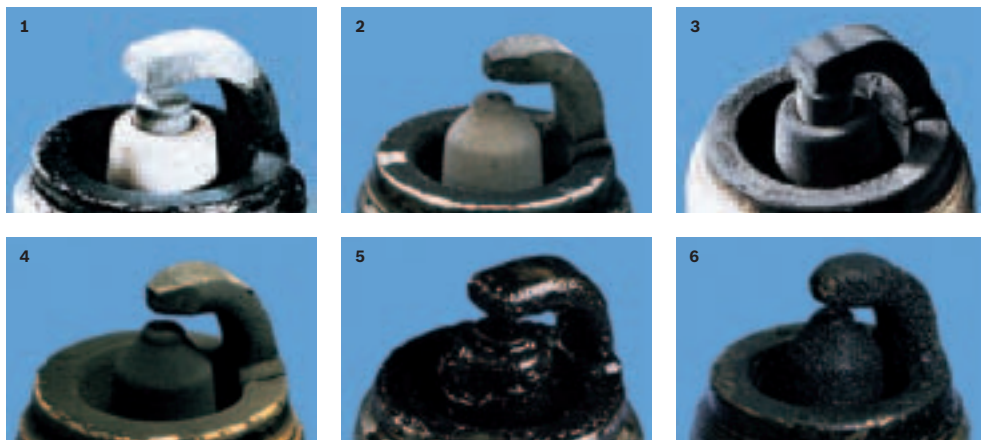

1 + 2 Нормальное состояние

Тепловой конус изолятора между серо-белым, серо-желтым и светло-коричневым цветом. Двигатель в порядке. Калильное число выбрано правильно. Регулирование состава смеси и установка зажигания правильные, нет пропусков искрообразования, устройство для пуска холодного двигателя функционирует. В моторном масле нет содержащих свинец отложений из присадок к топливу или легирующих компонентов. Нет тепловой перегрузки.

3 + 4 Покрытие сажей

Тепловой конус изолятора, электроды и корпус свечи зажигания покрыты шелкообразной, матовой черной сажей.

Причина: Неправильное регулирование состава смеси (карбюратор, система впрыска топлива): Слишком богатая смесь, сильно засорен воздушный фильтр, неисправность автоматического устройства для обогащения смеси при запуске двигателя или была долго включена тяга стартера (воздушная заслонка карбюратора), частые поездки на короткие расстояния, слишком холодная свеча зажигания, слишком низкое калильное число.

Последствия: Пропуски искрообразования, плохие пусковые качества.

Устранение: Правильно отрегулировать состав смеси и пусковое устройство, проверить воздушный фильтр.

5 + 6 Замасливание

Тепловой конус изолятора, электроды и корпус свечи зажигания покрыты блестящей сажей или масляным нагаром.

Причина: Слишком много масла в камере сгорания. Слишком высокий уровень масла, сильно изношены поршневые кольца, цилиндры и направляющие клапанов. У двухтактных ДВС слишком много масла в смеси.

Последствия: Пропуски искрообразования, плохие пусковые качества.

Устранение: Отремонтировать двигатель, залить правильную топливно-масляную смесь, заменить свечи зажигания.

Внешний вид теплового конуса



13



14



15

13 Оплавление центрального электрода

Оплавленный центральный электрод, пористая, губчатая, размягченная вершина теплового конуса изолятора.

Причина: Тепловая перегрузка за счет калильного зажигания, например, за счет слишком раннего зажигания, остаточных продуктов в камере сгорания, неисправных клапанов, неисправного распределителя зажигания и недостаточно высокого качества топлива. Возможно, слишком низкое калильное число.

Последствия: Пропуски искрообразования, потеря мощности (поломка двигателя).

Устранение: Проверить двигатель, зажигание и систему приготовления смеси. Установить новые свечи зажигания с правильным калильным числом.

14 Расплавление центрального электрода

Расплавленный центральный электрод, одновременно сильно поврежден боковой электрод.

Причина: Тепловая перегрузка за счет калильного зажигания, например, за счет слишком раннего зажигания, остаточных продуктов в камере сгорания, неисправных клапанов, неисправного распределителя зажигания и недостаточно высокого качества топлива.

Последствия: Пропуски искрообразования, потеря мощности, возможно, поломка двигателя. Возможно также образование трещины в тепловом конусе изолятора за счет перегретого центрального электрода.

Устранение: Внешний вид электродов в форме „цветной капусты“. Возможен осадок посторонних материалов.

15 Оплавление центрального электрода

Внешний вид электродов в форме „цветной капусты“. Возможен осадок посторонних материалов.

Причина: Тепловая перегрузка за счет калильного зажигания, например, за счет слишком раннего зажигания, остаточных продуктов в камере сгорания, неисправных клапанов, неисправного распределителя зажигания и недостаточно высокого качества топлива.

Последствия: Перед полным отказом (поломкой двигателя) возникает потеря мощности.

Устранение: Проверить двигатель, зажигание и систему приготовления смеси. Заменить свечи зажигания.



16 Сильный износ центрального электрода

Причина: Не соблюден интервал замены свечей зажигания.

Последствия: Пропуски искрообразования, особенно при ускорении (напряжения зажигания уже недостаточно для большого зазора между электродами). Плохие пусковые качества.

Устранение: Заменить свечи зажигания.



17 Сильный износ бокового электрода

Причина: Агрессивные присадки к топливу и маслу.

Неблагоприятные условия обтекания в камере сгорания, возможно, из-за отложений, стук в двигателе. Нет тепловой перегрузки.

Последствия: Пропуски искрообразования, особенно при ускорении (напряжения зажигания уже недостаточно для большого зазора между электродами). Плохие пусковые качества.

Устранение: Заменить свечи зажигания.



18 Разрушение теплового конуса изолятора

Причина: Механическое повреждение в результате удара, падения или надавливания на центральный электрод при неправильном обращении со свечой. За счет отложений между центральным электродом и тепловым конусом изолятора и за счет коррозии центрального электрода - особенно при слишком длительной работе - может треснуть тепловой конус изолятора.

Последствия: Пропуски искрообразования, искра проскакивает в местах, недоступных для рабочей смеси.

Устранение: Заменить свечи зажигания.



Советы фирмы Bosch



← Плоская уплотнительная поверхность

① ②

M 10 x1	10...15	10...15
M 12 x1,25	15...25	15...20
M 14 x1,25 <13 mm	20...25	15...20
M 14 x1,25 >13 mm	20...40	20...30
M 18 x1,5	30...45	20...35

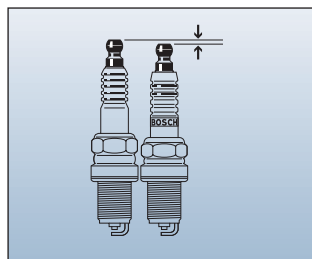
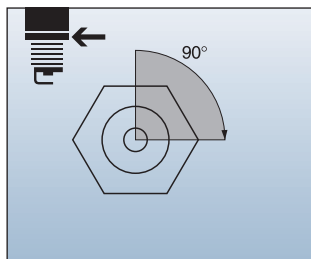

← Коническая уплотнительная поверхность

① ②

M 14 x1,25	20...40	10...20
M 18 x1,5	30...45	15...23

① чугун
② легкий сплав

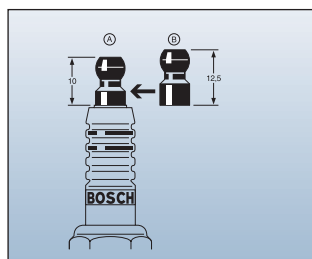
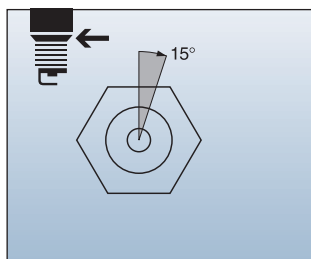

Правильная установка свечей зажигания с помощью динамометрического ключа:

Момент затяжки (Н • м):

10 Н • м ≈ 1 кгс • м

Обратите внимание:

Моменты затяжки указаны для сухой, несмазанной резьбы и для новых уплотнительных колец. При смазанной резьбе указанные моменты затяжки необходимо уменьшить на 1/3.

Правильная установка свечей зажигания без динамометрического ключа:

Обратите внимание:

Рукой вкрутить свечу зажигания до упора в головку цилиндров. Свечи зажигания с плоской уплотнительной поверхностью и новым уплотнением поворачиваются свечным ключом еще примерно на 90°. Свечи зажигания с конической уплотнительной поверхностью и свечи зажигания с бывшим в употреблении плоским уплотнительным кольцом поворачиваются еще примерно на 15°. Свечи зажигания со сплошным уплотнительным кольцом разрешается устанавливать только с помощью динамометрического ключа.

Контактные гайки свечей зажигания

Обратите внимание:

В двигателе могут быть установлены свечи зажигания, отличающиеся по длине от свечей Bosch.

1. Выкрутить старые свечи зажигания
2. Сравнить со свечами Bosch.
3. Если заменяемая свеча длиннее, чем свеча Bosch, тогда необходимо заменить привинченную контактную гайку А на прилагаемую контактную гайку В.

Внимание!

Рекомендации по свечам зажигания установлены фирмой Bosch, если они не исходят от изготовителя автомобиля или двигателя. Рекомендуемые свечи зажигания рассчитаны на нормальные условия эксплуатации в серийных моделях, не для гоночных, специальных и высокомоментных моделей, за исключением тех случаев, когда такие модели указаны специально.

При особых условиях эксплуатации может потребоваться использование других, а не рекомендуемых калильных чисел. Рекомендуемые свечи зажигания рассчитаны на нормальные условия эксплуатации в серийных моделях, не для гоночных, специальных и высокомоментных моделей свечной шупл фирмы Bosch (см. стр. А 101).

Оснастка

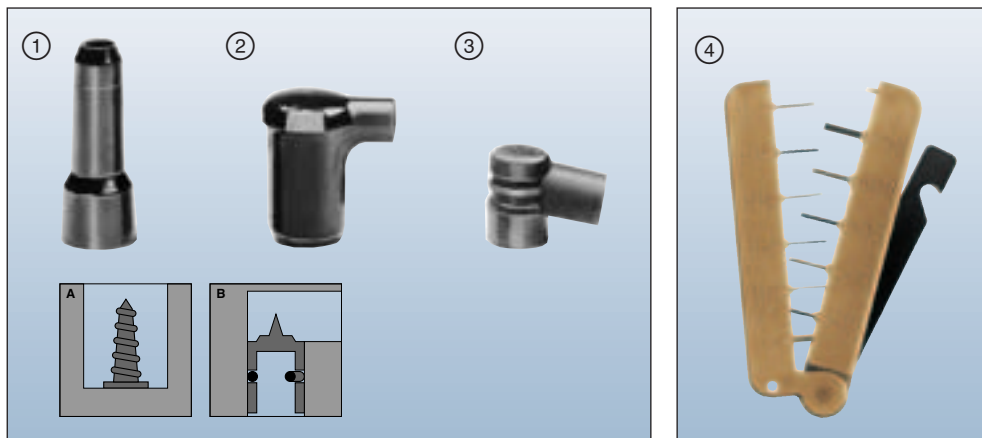

① – ③ Наконечник провода к свече зажигания (без помехоподавления)

Подключение свечи зажигания	Длина мм	Провод высокого напряжения Ø мм	Примечания	Рис.	Номер для заказа
M 4	52	7		① A	0 356 002 001
	39/35 ¹⁾	7		② B	0 356 050 001
Водонепроницаемость					
M 4	24/30 ¹⁾	5	Для свечей зажигания короткой конструкции	(WK ..) ③ A	0 356 050 009
				(WS ..) ③ A	0 356 050 010

¹⁾ Сторона свечи зажигания/Сторона провода высокого напряжения

④ Щуп

для проверки и регулировки зазора между электродами

Номер для заказа **0 986 600 000**

Изоляционная паста (без рисунка).

Цвет: белый.

Точка плавления: 320 °C

Характеристики: Воскообразная, без запаха, улучшенные изоляционные свойства соединений вторичной цепи системы зажигания, предотвращение пробоев головки свечи зажигания.

Применение: наконечники проводов к свечам зажигания, наконечники с помехоподавляющим резистором, защитные колпаки, крышки распределителя и т.п.

Техпаспорт безопасности ЕС: **1 987 123 010**

Тюбик 45 мл **1 987 123 010**

Соединительная гайка (без рисунка)

Для соединительной резьбы свечи зажигания M4. Литые под давлением из цинка, без покрытия, 25 штук в упаковке

Длина 10 мм **1 243 345 023**

Длина 12,5 мм **1 243 345 025**

Плоское уплотнительное кольцо (без рисунка)

Для свечей зажигания с свертной резьбой

M 14 x 1,25 **1 240 280 028**



W 9 DC	0 241 229 715	0,8	Ni ³⁾		M 14x1,25	19,0	20,8	•	Ma	316 514 357 482 9	316 514 357 483 6
WR 07 CS	0 242 274 501	0,6	Silver	R	M 14x1,25	19,0	20,8	•	Ma	404 702 463 862 4	404 702 463 863 1
WR 09 AC	0 242 268 500	0,6	Ni ³⁾	R	M 14x1,25	12,7	20,8	•	Ma	404 702 463 858 7	404 702 463 859 4
WR 09 CC	0 242 265 500	0,8	Ni ³⁾	R	M 14x1,25	19,0	20,8	•	Ma	404 702 459 487 6	404 702 459 488 3
WR 2 AC	0 242 260 500	0,7	Ni ³⁾	R	M 14x1,25	12,7	20,8	•	Ma	404 702 460 348 6	404 702 460 349 3
WR 3 BCO	0 242 255 515	0,6	Ni ³⁾	R	M 14x1,25	12,7	20,8	•	Ma	404 702 463 860 0	404 702 463 861 7
WR 3 CC	0 242 255 502	0,7	Ni ³⁾	R	M 14x1,25	19,0	20,8	•	Ma	316 514 122 202 9	316 514 122 203 6
WR 3 CS	0 242 255 504	0,6	Silver	R	M 14x1,25	19,0	20,8	•	SAE	316 514 314 077 2	316 514 314 078 9
WR 4 CC	0 242 250 503	0,7	Ni ³⁾	R	M 14x1,25	19,0	20,8	•	Ma	316 514 105 136 0	316 514 105 715 7
WR 5 AC	0 242 245 517	0,5	Ni ³⁾	R	M 14x1,25	12,7	20,8	•	Mb	316 514 105 127 8	316 514 105 706 5
WR 5 BC	0 242 245 531	0,7	Ni ³⁾	R	M 14x1,25	12,7	20,8	•	Ma	316 514 105 782 9	316 514 353 465 6
WR 5 BCO	0 242 245 577	0,8	Ni ³⁾	R	M 14x1,25	12,7	20,8	•	Ma	404 702 468 399 0	404 702 468 400 3
WR 5 CC	0 242 245 521	0,8	Ni ³⁾	R	M 14x1,25	19,0	20,8	•	Mb	316 514 105 130 8	316 514 105 709 6
WR 5 DC+	0 242 245 552	0,8	Ni-Y ²⁾	R	M 14x1,25	19,0	20,8	•	Ma	316 514 313 446 7	316 514 352 722 1
WR 6 BC	0 242 240 561	0,7	Ni ³⁾	R	M 14x1,25	12,7	20,8	•	Ma	316 514 115 543 3	316 514 115 544 0
WR 7 AC	0 242 235 533	0,5	Ni ³⁾	R	M 14x1,25	12,7	20,8	•	Ma	316 514 105 080 6	316 514 105 583 2
WR 7 BC+	0 242 235 665	0,8	Ni-Y ²⁾	R	M 14x1,25	12,7	20,8	•	Ma	316 514 352 709 2	316 514 352 710 8
WR 7 DC+	0 242 235 663	0,8	Ni-Y ²⁾	R	M 14x1,25	19,0	20,8	•	Ma	316 514 313 408 5	316 514 352 648 4
WR 7 DCX+	0 242 235 707	1,1	Ni-Y ²⁾	R	M 14x1,25	19,0	20,8	•	Ma	316 514 323 522 5	316 514 352 744 3
WR 9 DC+	0 242 229 656	0,8	Ni-Y ²⁾	R	M 14x1,25	19,0	20,8	•	Ma	316 514 313 424 5	316 514 352 668 2
WR 9 DCX+	0 242 229 687	1,1	Ni-Y ²⁾	R	M 14x1,25	19,0	20,8	•	Ma	316 514 323 524 9	316 514 352 746 7

X

X 4 CC	0 241 150 504	0,7	Ni ³⁾		M 12x1,25	19,0	17,5	•	Ma	316 514 165 034 1	316 514 165 035 8
XR 2 CEO	0 242 160 503	0,7	Ni-Y ²⁾	R	M 12x1,25	19,0	17,5	•	Ma	404 702 488 539 4	404 702 488 540 0
XR 4 CC	0 242 150 507	0,7	Ni ³⁾	R	M 12x1,25	19,0	17,5	•	Ma	404 702 483 780 5	404 702 483 781 2
XR 4 DC	0 242 150 505	0,9	Ni ³⁾	R	M 12x1,25	19,0	17,5	•	Mb	316 514 119 158 5	316 514 119 159 2
XR 5 DC	0 242 145 516	0,9	Ni ³⁾	R	M 12x1,25	19,0	17,5	•	SAE	404 702 451 115 6	404 702 451 116 3
XR 7 DC	0 242 135 502	0,9	Ni ³⁾	R	M 12x1,25	19,0	17,5	•	Ma	316 514 165 038 9	316 514 165 039 6

Y

YR 4 DE	0 242 150 506	0,9	Ni-Y ²⁾	R	M 12x1,25	19,0	16,0	•	Ma	404 702 468 397 6	404 702 468 398 3
YR 6 DES	0 242 140 519	0,7	Ni-Y ²⁾	R	M 12x1,25	19,0	16,0	•	Ma	404 702 455 858 8	404 702 455 859 5
YR 7 DC+	0 242 135 515	0,9	Ni-Y ²⁾	R	M 12x1,25	19,0	16,0	•	SAE	404 702 411 543 9	404 702 411 544 6

1) 2) 3) 4) Footnote legend see page 104

mm	0,50	0,55	0,60	0,65	0,70	0,75	0,80	0,90	1,00	1,10	1,20	1,35	1,50	2,00
inch	0.020	0.022	0.024	0.025	0.028	0.030	0.032	0.036	0.040	0.044	0.048	0.054	0.060	0.080

A 104**de****Hinweise zu ⁴⁾
Anschlussart**
(siehe A102)**en****Notes on ⁴⁾
Connection type**
(see A102)**fr****Remarques con-
cernant ⁴⁾ Mode
de raccordement**
(voir A102)**it****Avvertenze
relative a ⁴⁾
Tipo collegamento**
(vedi A102)**es****Indicaciones
sobre ⁴⁾
Tipo de conexión**
(véase A102)**Anschlussart**

M 4

Ma

Mb

SAE

Anschluss der Zündkerze

mit Gewindebolzen M 4

mit DIN/SAE-Mutter aufgeschraubt,
abschraubbarmit Gewindebolzen M 4,
DIN/SAE-Mutter beigelegtmit festem DIN/SAE-Kopf
oder unlösbarer DIN/SAE-Mutter**Tipo collegamento
d'accensione**

M 4

Ma

Mb

SAE

Collegamento della candela

con perno filettato M 4

avvitato con dado DIN/SAE, svitabile

con perno filettato M 4,
dado DIN/SAE acclusocon testa DIN/SAE fissa o
dado DIN/SAE non allentabile**Connection type**

M 4

Ma

Mb

SAE

Spark plug connection

with threaded pin M 4

with DIN/SAE nut screwed on,
can be unscrewedwith threaded pin M 4,
DIN/SAE nut suppliedwith fixed DIN/SAE head or non-detachable
DIN/SAE nut**Tipo de conexión**

M 4

Ma

Mb

SAE

Conexión de la bujía de encendido

con perno roscado M 4

con tuerca DIN/SAE enroscada,
desenroscablecon perno roscado M 4,
tuerca DIN/SAE adjuntacon cabeza fija DIN/SAE o
tuerca DIN/SAE imperdible**Mode de raccord.**

M 4

Ma

Mb

SAE

Raccordement pour bougie d'allumage

avec axe fileté M 4

avec écrou DIN/SAE vissé, dévissable

avec axe fileté M 4, écrou DIN/SAE joint

avec tête DIN/SAE fixe ou écrou DIN/SAE
inamovible¹⁾ Tabelle mm - inch¹⁾ Table mm - inch¹⁾ Tableau mm - inch¹⁾ Tabella mm - inch¹⁾ Tabla mm - inch¹⁾ Tabela mm - inch¹⁾ Lijst mm - inch¹⁾ Bordläggma mm - inch¹⁾ Tabulka mm - inch¹⁾ Таблица мм - inch²⁾ Nickel-Yttrium-Elektrode²⁾ Nickel-yttrium electrode²⁾ Electrode en nickel-yttrium²⁾ Elettrodo al Nichel-Yttrium²⁾ Electrodo de níquel-itrio²⁾ Eléctrodo de níquel-itrio²⁾ Nikkel-yttrium-elektrode²⁾ Nickel-yttrium elektrod²⁾ Elektroda nikel-yttrium²⁾ Никель-иттриевый электрод³⁾ Nickel-Chrom Elektrode³⁾ Nickel-chrome electrode³⁾ Electrode en nickel-chrome³⁾ Elettrodo al Nichel-cromo³⁾ Eléctrodo de níquel-cromo³⁾ Eléctrodo de níquel-cromo³⁾ Nikkel-chroom-elektrode³⁾ Nickel-krom elektrod³⁾ Elektroda nikel-chrom³⁾ Никель-хром электрод

pt

Notas sobre ⁴⁾
Tipo de conexão
 (ver A102)

nl

Instructies voor ⁴⁾
Soort aansluiting
 (zie A102)

sv

Anvisningar för ⁴⁾
Anslutningssätt
 (se A102)

cs

Upozornění k ⁴⁾
Druhu připojení
 (viz A102)

ru

**Примечания к
сноске ⁴⁾**
Вид подключения
 (см. A102)



Tipo de conexão	Conexão da vela de ignição	Druhu připojení	Připojení zapalovací svíčky
M 4	com rosca M 4	M 4	se závitovými svorníky M 4
Ma	com porca DIN/SAE enroscada, desenroscável	Ma	s matiči DIN/SAE našroubovatelnou, odšroubovatelnou
Mb	com prisioneiro M 4, porca DIN/SAE fornecidos	Mb	se závitovými svorníky M 4, DIN/SAE, matice přiloženy
SAE	com cabeça DIN/SAE fixa ou porca DIN/SAE que não pode ser solta	SAE	s pevnou hlavou DIN/SAE nebo neuvolnitelnou matiči DIN/SAE
Soort aansluiting	Aansluiting van de bougie	Вид подключения	Подключение свечи зажигания
M 4	met schroefdraadbout M 4	M 4	Со шпилькой M 4
Ma	met DIN/SAE-moer opgeschroefd, afschroefbaar	Ma	С навинченной гайкой DIN/SAE, съёмной
Mb	met schroefdraadbout M 4, DIN/SAE-moer bijgesloten	Mb	Со шпилькой M 4, гайка DIN/SAE прилагается
SAE	met vaste DIN/SAE-kop of niet afschroefbare DIN/SAE-moer	SAE	С жесткой головкой DIN/SAE или неснимаемой гайкой DIN/SAE
Anslutningssätt	Anslutning av tändstift		
M 4	med gängbult M 4		
Ma	påskruvad med DIN/SAE-mutter, avskruvbar		
Mb	med gängbult M 4, DIN/SAE-mutter bifogad		
SAE	med fast DIN/SAE-huvud eller icke avskruvbar DIN/SAE-mutter		

Zündkerzen-Gewährleistung

1. Bosch-Zündkerzen können in allen Motoren entsprechend den von Bosch herausgegebenen geltenden Empfehlungen verwendet werden.
2. Bosch leistet Gewähr für zugesicherte Eigenschaften und Fehlerfreiheit entsprechend dem jeweiligen Stand der Technik.
3. Die Gewährleistungsfrist für Material- und Herstellfehler beträgt 24 Monate. Normaler Verschleiß ist von der Gewährleistung ausgenommen.
4. Falls nachweisbar durch die Verwendung von Bosch-Zündkerzen gemäß den von Bosch herausgegebenen Empfehlungen Schäden am Motor entstehen, so übernimmt Bosch ganz oder teilweise die für die Schadenbehebung entstandenen Kosten. Voraussetzung ist, dass der Einbau der Zündkerzen sachgemäß erfolgte. Die Entscheidung über eine Kostenübernahme trifft Bosch nach Vorlage der beanstandeten Zündkerzen, der beschädigten Motorenteile sowie der Reparaturrechnung.

Benutzerhinweise

Für Änderungen der Ausrüstung durch die Fahrzeug-, Motoren- und Gerätehersteller oder die Hersteller von Erzeugnissen anderer Marken übernehmen wir keine Gewähr.

Spark Plugs Warranty

1. Bosch spark plugs can be used in all engines in accordance with valid recommendations issued by Bosch.
2. Bosch warrants assured features and flawless operation in accordance with the current State of the Art.
3. The warranty period for material and manufacturing defects is 24 months. Normal wear and tear are not covered by the warranty.
4. If engine damage occurs which can be proved to be attributed to the use of Bosch spark plugs fitted in accordance with recommendations issued by Bosch, Bosch will assume all or part of the costs of repairing the damage, subject to the spark plugs having been properly installed. Bosch decide whether to assume the costs after submission of the spark plugs in question, the damaged engine parts and the bill for the repair works.

Notes for Users

We accept no liability for changes in equipment made by the manufacturers of vehicles, engines and equipment or by the manufacturers of non-Bosch products.

Bougies d'allumage Garantie

1. Les bougies d'allumage Bosch peuvent être utilisées sur tous les moteurs, conformément aux préconisations en vigueur publiées par Bosch.
2. Bosch garantit les caractéristiques techniques données, la qualité des matériaux employés et le bon fonctionnement, conformément aux derniers progrès techniques.
3. Le délai de garantie pour les défauts de matière et de fabrication est de 24 mois. L'usure normale est exclue de la garantie.
4. Si l'on peut prouver que l'utilisation des bougies d'allumage Bosch, conformément aux préconisations publiées par Bosch, a entraîné une détérioration du moteur, Bosch prend en charge la totalité ou une partie des frais de réparation, à condition que les bougies aient été montées correctement. Bosch décidera de la prise en charge des frais sur présentation des bougies incriminées, des pièces endommagées du moteur ainsi que de la facture de réparation.

A l'attention de l'utilisateur

Nous n'assumons aucune responsabilité pour les modifications d'équipement apportées par les constructeurs de véhicules, de moteurs et d'appareils ou par les fabricants de produits d'autres marques.

Garanzia candele

1. Le candele Bosch possono essere impiegate in tutti i motori seguendo le indicazioni in corso di validità pubblicate da Bosch.
2. Bosch fornisce la garanzia legale per difetti tecnici di fabbricazione.
3. La durata della garanzia per difetti tecnici di materiale e di fabbricazione è di 24 mesi a partire dalla data di acquisto o di installazione. La normale usura non rientra nella garanzia.
4. Nel caso si verifichino danni al motore direttamente causati dall'uso di candele Bosch, Bosch si assume del tutto o in parte le spese necessarie per l'eliminazione del guasto, premesso che si possa provare che il montaggio delle candele e il relativo uso siano avvenuti correttamente secondo le indicazioni pubblicate da Bosch. Bosch deciderà se assumersi le spese dopo aver preso visione delle candele, che sono motivo del reclamo, delle parti del motore danneggiate e del costo della riparazione.

Avvertenze per la consultazione

Non assumiamo nessuna responsabilità per modifiche apportate all'equipaggiamento da parte delle case costruttrici di veicoli, motori ed apparecchi o da parte dei costruttori di prodotti d'altra marca.

Bujías Garantía

1. Las Bujías Bosch pueden emplearse para todos los motores de acuerdo a las recomendaciones vigentes publicadas por la casa Bosch.
2. La casa Bosch cumple los requisitos de garantía legal en lo que se refiere a las cualidades prometidas y la ausencia de defectos, de conformidad con el estado actual de la técnica.
3. La duración de la garantía por defectos de material y de fabricación está limitada a 24 meses. La garantía no cubre los desgastes naturales.
4. Caso de que ocurran averías en el motor y cuya causa, según se compruebe, sea el empleo de bujías Bosch conforme a las recomendaciones publicadas por esta casa, los gastos derivados de la eliminación de dicha avería serán sufragados en su totalidad o en parte por Bosch. Requisito para ello es el que las bujías hayan sido convenientemente montadas. La decisión en cuanto a sufragar los gastos será adoptada por la casa Bosch tras la presentación de las bujías objeto de la reclamación, las piezas averiadas del motor así como la factura de la reparación del mismo.

Instrucciones para el usuario

No nos responsabilizamos de las modificaciones en los equipos hechas por los fabricantes de los vehículos, motores y aparatos, o bien por los fabricantes de productos de otras marcas.

pt

Garantia das velas de ignição

1. As velas de ignição da Bosch podem ser utilizadas em todos os motores, de acordo com as recomendações vigentes publicadas pela Bosch.
2. A Bosch assegura as propriedades e a não existência de erros em conformidade com o respectivo estado da técnica.
3. O prazo da garantia para defeitos de material e de fabrico é de 24 meses. O desgaste normal não é coberto pela garantia.
4. Se se comprovar a ocorrência de danos no motor depois de utilizar velas de ignição da Bosch, de acordo com conforme as recomendações publicadas pela Bosch, esta assume, total ou parcialmente, os custos resultantes da resolução dos danos. A montagem correcta das velas de ignição é um pré-requisito. A Bosch decide se assume os custos depois de apresentadas as despesas relativas às velas de ignição que provocaram a reclamação e às peças de motor danificadas e, também, depois de apresentada a factura de reparação.

Instruções para o utilizador

Não nos responsabilizamos por quaisquer alterações do equipamento efectuadas pelos fabricantes do veículo, dos motores e dos aparelhos ou pelos fabricantes de produtos de outras marcas.

nl

Bougiegarantie

1. Bosch-bougies kunnen in alle motoren overeenkomstig de door Bosch uitgegeven geldende adviezen worden gebruikt.
2. Bosch geeft garantie voor toegezegde eigenschappen en foutloosheid overeenkomstig de heersende stand van de techniek.
3. De garantietermijn voor materiaal- en fabricagefouten bedraagt 24 maanden. Normale slijtage valt niet onder de garantie.
4. Indien aantoonbaar door gebruik van Bosch-bougies conform de door Bosch uitgegeven adviezen schade aan de motor ontstaat, dan aanvaardt Bosch geheel of gedeeltelijk de kosten die zijn ontstaan om de schade te verhelpen. Voorwaarde is, dat de montage van de bougies deskundig plaatsvond. De beslissing over het aanvaarden van de kosten neemt Bosch na overlegging van de gereclameerde bougies, van de beschadigde motoronderdelen als ook van de reparatierkening.

Gebruikersinstructies

Voor wijzigingen van de uitrusting door de voertuig-, motoren- en apparatenfabrikant of de fabrikanten van certificaten van andere merken aanvaarden wij geen garantie.

sv

Tändstiftsgaranti

1. Bosch-tändstiften kan användas i alla motorer enligt de aktuella rekommendationer Bosch lämnat.
2. Bosch garanterar tillförsäkrade egenskaper och felfri kvalitet baserande på modern teknik.
3. För material- och tillverkningsfel lämnas 24 månaders garanti. För normalt slitage lämnas ingen garanti.
4. Om skador påvisbart uppstår på motorn vid användning av Bosch-tändstift enligt de rekommendationer som Bosch lämnar, står Bosch helt eller partiellt för kostnaderna i samband med avhjälpande av skada. Förutsättningen är att tändstiften monterats på korrekt sätt. Efter kontroll av reklamerade tändstift, skadade motordelar samt reparationsfakturan avgör Bosch i vilken omfattning kostnaderna övertas. Förutsättningen är att tändstiften monterats på korrekt sätt. Efter kontroll av reklamerade tändstift, skadade motordelar samt reparationsfakturan avgör Bosch i vilken omfattning kostnaderna övertas.

Användarvägledning

Vi fritar oss från allt ansvar för ändringar av utrustning som fordons-, motor- och apparattillverkarna eller producenterna av produkter av andra fabrikat gjort.

cs

Záruky na zapalovací svíčky

1. Zapalovací svíčky Bosch mohou být použity ve všech motorech v souladu s platnými doporučeními vydanými firmou Bosch.
2. Bosch poskytuje záruku na dodržení vlastností a bezchybnosti v souladu s příslušným stavem techniky.
3. Záruční lhůta na materiál a výrobní vady je 24 měsíců. Normální opotřebení je ze záruky vyloučeno.
4. Pokud v důsledku použití zapalovacích svíček prokazatelně používaných v souladu s platnými doporučeními vydanými firmou Bosch dojde k poškození motoru, přebírá Bosch celou nebo částečnou úhradu nákladů na opravu poškození.

Předpokladem je odborné provedení montáže zapalovacích svíček.

Rozhodnutí o převzetí úhrady nákladů uskuteční Bosch po předložení příslušných zapalovacích svíček, poškozených částí motoru a účtu za opravu.

Pokyny pro uživatele

Neručíme za změny výbavy provedené výrobcí vozidel, motorů a přístrojů nebo výrobcí produktů jiných značek.

ru

Гарантия на свечи зажигания

1. Свечи зажигания Bosch можно использовать в любых двигателях в соответствии с действующими рекомендациями фирмы Bosch.
2. Фирма Bosch ручается за гарантированные характеристики и исправное состояние в соответствии с актуальным уровнем техники.
3. Гарантийный срок на дефекты материалов и производственный брак составляет 24 месяцев. На обычный износ гарантия не распространяется.
4. Если будет доказано, что в результате использования свечей зажигания Bosch в соответствии с рекомендациями фирмы Bosch был поврежден двигатель, то фирма Bosch полностью или частично берет на себя расходы по устранению повреждения. Условием является правильная установка свечей зажигания. Решение о взятии на себя расходов фирма Bosch принимает после предоставления дефектных свечей зажигания, поврежденных деталей двигателя и счета за ремонт.

Советы для пользователя

Мы не берем на себя гарантию за изменения оборудования, внесенные производителями автомобилей, двигателей и устройств или производителями изделий других марок.

en

① Explanation of symbols

See end of catalog for explanation

② Vehicle brand

Manufacturer indicated in bold print within gray bar

③ Engine displacement

special vehicle information

⑤ Installation period

Installation period for relevant product

⑥ Special case

See end of catalog for explanation

⑦ Order number

For aftermarket orders

⑧ Type designation

Specifically selected and checked for every vehicle type. Short and easy to remember. Easy to find on the package

⑨ Cylinders

Number of cylinders in engine

⑩ Electrode gap in mm

The electrode gap for the engine in question is given after every type designation

fr

① Légende des symboles

Explication, voir la fin du catalogue

② Marque de véhicule

Mise en avant des constructeurs sur fond gris

③ Cylindrée

Caractéristiques du véhicule

⑤ Période de montage

Période de montage du produit considéré

⑥ Cas particulier

Explication, voir la fin du catalogue

⑦ Référence

pour le réapprovisionnement des revendeurs

⑧ Formule de type

Sélectionnée et vérifiée spécialement pour chaque type de véhicule. Concise et facile à retenir pour recherche simple et rapide. Mentionnée également sur l'emballage

⑨ Cylindres

Nombre de cylindres du moteur

⑩ Écartement des électrodes en mm

L'écartement des électrodes pour le type de moteur considéré est indiqué à la suite de chaque formule de type

it

① Legenda dei simboli

Indicazioni a fine catalogo

② Marca del veicolo

Evidenziata con fondo grigio

③ Cilindrata

④ **Dettagli modello**
particolari caratteristiche del veicolo

⑤ Periodo di montaggio

Del rispettivo ricambio

⑥ Casi speciali

Indicazioni a fine catalogo

⑦ Codice ordinazione

Per il riordino da parte di rivenditori

⑧ Sigla

Specifica per ciascun tipo di veicolo testata e consigliata. Ricerca semplice e veloce anche sulla confezione.

⑨ Cilindri

Numero dei cilindri presenti nel motore

⑩ Distanza elettrodi in mm

A lato di ogni sigla viene riportata la distanza elettrodi per ciascun tipo di motore

es

① Explicación de símbolo gráfico

Explicación, véase la parte final del catálogo

② Marca de vehículo

Fabricante destacado en la franja gris

③ Cilindrada

④ **Detalle de modelo**
Características especiales del vehículo

⑤ Periodo de instalación

Periodo durante el que se instala el producto en cuestión

⑥ Caso especial

Explicación, véase la parte final del catálogo

⑦ Referencia de pedido

para pedidos posteriores por el comercio

⑧ Fórmula Tipo

Seleccionada y verificada especialmente para cada tipo de vehículo. Concisa y fácil de recordar. Fácil de encontrar en el paquete

⑨ Cilindros

Número de cilindros existentes en el motor

⑩ Distancia entre electrodos

necesaria en función del motor

pt

Notas sobre a utilização

nl

Aanwijzingen voor het gebruik

sv

Användnings- vägledning

cs

Pokyny pro užití

ru

Примечания по использованию

B2 | AJP

1 → 

2 → **AJP**

3 →	125 cc Enduro/ Supermoto	01.03 →	1	0242 160 503	XR 2 CE 0	0,8	7
4 →	200 cc Enduro/ Supermoto	01.03 →	1	0242 160 503	XR 2 CE 0	0,8	
5 →	250 cc P Cross	01.04 →	1	0242 065 500	UR 09 CC	0,6	8

ALFER

6 →	125 cc VRE	01.97 →	1	0242 068 500	UR 08 CC	0,7	
	250 cc EGR	01.80-12.90	1	0241 248 538	W 4 CC	0,5	
	VR	01.97 →	1	0242 250 503	WR 4 CC	0,8	
	300 cc AR 1	01.80 →	1	0241 248 538	W 4 CC	0,5	
	GR Aqua	01.88 →	1	0241 248 538	W 4 CC	0,5	
	TX	01.90 →	1	0241 248 538	W 4 CC	0,5	9

A 

AMERICAN IRON HORSE

	1600 cc Bandit/ Classic/ Legend/ Outlaw/ Slammer/ Stalker/ Thunder	01.99-12.02	2	0242 229 687	WR 8 DCX+	1,0	10
	1750 cc Bandit/ Classic/ Legend/ Outlaw/ Slammer/ Stalker/ Thunder	01.99-12.03	2	0242 229 687	WR 8 DCX+	1,0	
	1800 cc Legend/ LSC/ Outlaw/ Slammer/ Stalker/ Tejas/ Texas Chopper	01.04 →	2	0242 135 515	YR 7 DC+	1,0	
	1850 cc Bandit/ Classic/ Legend/ Outlaw/ Slammer/ Stalker/ Thunder	01.99-12.03	2	0242 229 687	WR 8 DCX+	1,0	
	1900 cc Legend/ Outlaw/ Slammer/ Stalker/ Tejas/ Texas Chopper	01.04 →	2	0242 135 515	YR 7 DC+	1,0	
	2000 cc Legend/ Outlaw/ Ranger/ Slammer/ Stalker/ Tejas/ Texas Chopper	01.03 →	2	0242 135 515	YR 7 DC+	1,0	

ANCILOTTI

	125 cc PST MX, RG	01.83-12.94	1	0241 274 505	W 07 CS	0,6	
--	----------------------	-------------	---	--------------	---------	-----	--

Bosch Automotive Aftermarket 2014 | 2015

pt

1 **Objašnienje simboli**
na kořcu katalogu

2 **Marca do veiculo**
Fabricantes destacados na
barra cinzenta.

3 **Cilindrada**

4 **Pormenor do modelo**
Características especiais
do veiculo.

5 **Período de instalação**

6 **Caso especial**
Explicação, ver final do catálogo.

7 **Referencia**
de 10 dígitos

8 **Designação**
Especialmente testada e seleccionada para cada tipo de veiculo. Breve e simples de memorizar para ser facilmente encontrada também na embalagem.

9 **Número de cilindros**

10 **Distância entre eléctrodos em mm**

Nas velas de ignição Standard e Super a distância entre os eléctrodos faz parte da designação e, em caso de substituição, tem de ser tomada em consideração.

Let op: Alleen bougies met de juiste typeformule en de vooraf gegeven elektrodenafstand garanderen een onberispelijk functioneren van de motor.

OBS! Endast tändstift med korrekt typformel och givet elektroдавstånd garanterar att motorn fungerar felritt.

Atenção: o bom funcionamento do motor só é garantido com a utilização de velas de ignição com a designação e modelo correcto e com a distância especificada entre os eléctrodos.

Pozor: Bezvadná funkce motoru je zajištěna jen při použití zapalovacích svíček se správným typovým označením a předepsanou vzdáleností elektrod.

Внимание: Только свечи зажигания с правильной маркировкой и предписываемым зазором между электродами обеспечивают безупречную работу двигателя.

nl

① Toelichting van de symbolen

Toelichting zie einde van de catalogus.

② Merk voertuig

Accentuering van de fabrikanten in de grijze balk.

③ Cilinderinhoud**④ Modeldetail**

Bijzondere voertuigkenmerken.

⑤ Inbouwperiode

Inbouwperiode van het betreffende product

⑥ Speciaal geval

Toelichting zie einde van de catalogus.

⑦ Bestelnummer

Voor nabestellingen voor de handel

⑧ Typeformule

Speciaal voor elk voertuigtype gekeurd en geselecteerd. Kort en gemakkelijk te onthouden voor gemakkelijk vinden, ook op de verpakking.

⑨ Aantal cilinders**⑩ Elektrodenafstand in mm**

De elektrodenafstand is een onderdeel van de typeformule bij standaard- en super-bougies en moet bij vervanging in acht genomen worden.

sv

① Bildsymbolernas förklaring

Se förklaring i slutet av katalogen.

② Fordonsmärke

Tillverkaren markerad i det grå fältet

③ Slagvolym**④ Modelldetalj**

Speciella fordonskännetecken

⑤ Monteringsperiod

Monteringsperiod för respektive produkt

⑥ Specialfall

Se förklaring i slutet av katalogen.

⑦ Ordernummer

För efterbeställning för handeln

⑧ Typformel

Speciellt kontrollerad och vald för varje fordonstyp. Kort och lätt att minnas, underlättar sökningen; finns även på förpackningen.

⑨ Cylinderantal**⑩ Elektrodavstånd i mm**

Elektrodavståndet ingår i typformeln för standard- och supertändstift och måste beaktas vid byte.

cs

① Symboly

Vysvětlení viz konec katalogu.

② Značka vozidla

Zvýraznění výrobce šedým pruhem.

③ Zdvihový objem**④ Detail modelu**

Zvláštní charakteristiky vozidla.

⑤ Období instalace

Období instalace příslušného produktu

⑥ Specální případy

Vysvětlení viz konec katalogu.

⑦ Objednací číslo

pro doobjednání pro obchod

⑧ Typové označení

Kontrolováno a vybráno jednoznačně pro každý typ vozidla. Krátké a snadno zapamatovatelné pro snadné vyhledání; je uvedeno také na obalu.

⑨ Číslo cylindru**⑩ Vzdálenost elektrod v mm**

Vzdálenost elektrod je součástí typového označení zapalovacích svíček Standard a Super. Při výměně musí být dodržena.

ru

① Разъяснение пиктограмм

См. разъяснения в конце каталога.

② Марка автомобиля

Выделение производителей серыми полосками.

③ Объем двигателя**④ Особенности модели**

Особые характеристики автомобиля.

⑤ Время установки

Время установки соответствующего изделия

⑥ Особый случай

См. разъяснения в конце каталога.

⑦ Номер артикула

Для оформления заказа см.

⑧ Маркировка

Специально проверена и выбрана для каждого типа автомобиля. Короткая и легко запоминающаяся, находится легко, также и на упаковке.

⑨ Количество цилиндров**⑩ Зазор между электродами в мм**

Зазор между электродами является составной частью маркировки свечей зажигания программ Standard и Super и должен учитываться при замене свечей.



Typ

**AIM****50 cc**

A 1	01.75-03.80	FE	1	0 242 235 663	WR 7 DC+	0,6
Babytrial	02.75-12.82		1	0 242 235 533	WR 7 AC	0,5
Enduro 50/6	01.77-12.81		1	0 241 260 507	W 2 AC	0,6
Mini	01.75-12.81	FE	1	0 242 235 663	WR 7 DC+	0,6
ZE/C	01.85-12.95			0 241 245 581	W 5 CC	0,5

ALFER**50 cc**

GR 30	01.80→		1	0 242 260 500	WR 2 AC	0,6
TX 30	01.80→		1	0 242 260 500	WR 2 AC	0,6

ANCILOTTI**50 cc**

Cio	01.83-12.85	FE	1	0 242 235 663	WR 7 DC+	0,6
Piu	12.83-12.85	FE	1	0 242 235 663	WR 7 DC+	0,6
Scarab 50	05.77-12.85		1	0 241 235 607	W 7 AC	0,5

APRILIA**50 cc**

AF1 50	01.86-12.94		1	0 241 256 522	W 3 CC	0,5
Classic 50	01.92→		1	0 242 250 503	WR 4 CC	0,8
ET 50 /AE/Fire/Tuareg	01.87→		1	0 241 256 522	W 3 CC	0,5
Europa 50	07.92-12.94		1	0 241 256 515	W 3 CS	0,6
			1	0 242 255 502	WR 3 CC	0,7
Filo G 4 LNT	01.81-12.87		1	0 242 235 533	WR 7 AC	0,5
GL 50	02.93→		1	0 241 256 522	W 3 CC	0,5
LX 50	02.93→		1	0 241 256 522	W 3 CC	0,5
MX 50	01.02-12.04		1	0 242 255 502	WR 3 CC	0,6
MX 50 ST	01.03-12.04		1	0 242 250 503	WR 4 CC	0,8
Partner RDL	01.80-12.85		1	0 241 235 607	W 7 AC	0,5
RC 50	01.79-12.82		1	0 241 235 089	W 7 CC	0,6
Red Rose 50	06.87-12.96		1	0 241 256 522	W 3 CC	0,5
RS 50	01.97-12.05		1	0 242 255 502	WR 3 CC	0,7
	01.06-12.10		1	0 242 255 502	WR 3 CC	0,6
RS 50 Extrema	01.93-12.98		1	0 241 248 538	W 4 CC	0,5
RS 50 Extrema Replica	01.93-12.98		1	0 241 248 538	W 4 CC	0,5
RS4 50	01.11→		1	0 242 250 503	WR 4 CC	
RX 50	01.83-12.98		1	0 241 256 522	W 3 CC	0,5
	01.95-12.01		1	0 242 250 503	WR 4 CC	
	01.02-12.06		1	0 242 255 502	WR 3 CC	
	01.06-12.11		1	0 242 250 503	WR 4 CC	0,6
	01.12→		1	0 242 274 501	WR 07 CS	
SX 50	01.06-12.11		1	0 242 250 503	WR 4 CC	0,6
	01.12→		1	0 242 274 501	WR 07 CS	
Tuono 50	01.03-12.04		1	0 242 255 502	WR 3 CC	



Typ



Under 18	01.79-12.82	1	0 241 235 607	W 7 AC	0,5
Under 21	01.79-12.83	1	0 241 235 755	W 7 DC	0,6
Under 23 M	01.79-12.83	1	0 241 235 755	W 7 DC	0,6

ASPES

50 cc					
Hopi	01.75-12.83		0 241 256 522	W 3 CC	0,5
Juma 6 M	01.75-12.81		0 241 256 522	W 3 CC	0,5
Navaho CRC 50	01.79-12.83	1	0 241 256 522	W 3 CC	0,5
Navaho RCL 50	01.79-12.83	1	0 241 256 522	W 3 CC	0,5
Navaho RCR 50	01.83-12.83	1	0 241 256 522	W 3 CC	0,5
Scrambler	01.75-12.81		0 241 235 607	W 7 AC	0,5
Sioux	01.75-12.81		0 241 235 607	W 7 AC	0,5
Yak	01.75-12.81		0 241 256 522	W 3 CC	0,6

AT MOTO

50 cc					
S 3800	01.96→	1	0 241 235 607	W 7 AC	0,6

ATK

50 cc					
50 Mini Cross	01.99-12.01	1	0 241 245 580	W 5 AC	0,5
50 MX	01.99-12.03	1	0 241 245 580	W 5 AC	0,5

BATAVUS

50 cc					
Ascot	02.79-12.90	1	0 241 256 512	W 3 AC	0,5
Bronco	01.75-07.77	1	0 242 235 665	WR 7 BC+	0,5
Grand Prix	03.81-12.91	1	0 241 235 607	W 7 AC	0,5
HS 50	01.75-08.79	1	0 241 235 607	W 7 AC	0,5
	04.77-08.79	1	0 241 256 512	W 3 AC	0,5
HS 60	02.79-09.81	1	0 241 235 607	W 7 AC	0,5
Pronto VA	07.76-05.80	1	0 241 235 607	W 7 AC	0,5
Starflite Swing	09.76-07.79	1	0 242 235 533	WR 7 AC	0,5

BENELLI

50 cc					
Devil 50	09.91→	1	0 241 256 522	W 3 CC	0,6
E 3	01.89-06.89	1	0 241 256 522	W 3 CC	0,7
Export 3V	12.76-12.87	1	0 241 256 522	W 3 CC	0,7
G2 Elle /Pedali	01.83-06.89	1	0 241 235 607	W 7 AC	0,5
Laser 50	01.84-06.89	1	0 241 235 607	W 7 AC	0,5
S 50	04.81-06.89	1	0 241 235 607	W 7 AC	0,5
Spring 50	01.92-12.03	1	0 241 248 538	W 4 CC	0,5



Typ

**BETA-INTERMOTOR****50 cc**

Alp 50	01.90-12.96		1	0 241 248 538	W 4 CC	0,5
Andy	11.83-12.93		1	0 241 229 579	W 8 CC	0,5
B 12	12.80-12.82	XJC	1	0 241 229 579	W 8 CC	0,5
C 402	09.79-12.82		1	0 241 245 580	W 5 AC	0,5
Enduro 50 RK 6	01.95-12.00		1	0 241 248 538	W 4 CC	0,5
M 4 AE	05.84-12.93		1	0 241 245 580	W 5 AC	0,5
M 4 Spec.	10.82-12.92	XJB	1	0 241 235 607	W 7 AC	0,5
M 5 Spec.	01.77-11.79		1	0 241 256 522	W 3 CC	0,5
M 6	01.84-12.92		1	0 241 256 522	W 3 CC	0,5
Minicross 50	01.00→		1	0 241 245 580	W 5 AC	0,5
Minitrail 50	01.00→		1	0 241 245 580	W 5 AC	0,5
Motard 50	01.03→		1	0 242 255 502	WR 3 CC	0,6
MX 6 S	11.79-10.82		1	0 241 245 580	W 5 AC	0,5
MX 50	01.91-12.95		1	0 241 256 522	W 3 CC	0,5
REV 50	01.03-12.08		1	0 241 256 522	W 3 CC	0,5
RK6 50	01.94-12.97		1	0 241 248 538	W 4 CC	0,5
RR 50 Enduro	01.05→		1	0 242 255 502	WR 3 CC	0,6
ST 50	01.95-12.01		1	0 241 248 538	W 4 CC	0,5
Super Trial 50	01.92-12.01		1	0 241 248 538	W 4 CC	0,5
Zero 50	01.92-12.94		1	0 241 256 522	W 3 CC	0,5

BLATA**40 cc**

Elite 13	01.06-12.06		1	0 241 256 522	W 3 CC	0,5
Elite 13 W	01.07-12.07		1	0 241 256 522	W 3 CC	0,8

BSA**50 cc**

Beaver 50	01.79-12.89		1	0 241 235 607	W 7 AC	0,5
Boxer 50	01.79-12.89		1	0 241 235 607	W 7 AC	0,5
Brigand 50	01.79-12.89		1	0 241 235 607	W 7 AC	0,5
Easy Rider 50	01.79-12.89		1	0 241 235 755	W 7 DC	0,5

BSM**50 cc**

City 50	01.99-12.01		1	0 242 240 561	WR 6 BC	0,6
Off Road 50	01.99-12.01		1	0 242 240 561	WR 6 BC	0,6
Thunderbike 50	01.99-12.09		1	0 242 240 561	WR 6 BC	0,6
Winner 50	01.99-12.09		1	0 242 240 561	WR 6 BC	0,6



Typ

**BUFFALO****50 cc**

CY	01.97-12.98	1	0 242 245 517	WR 5 AC	0,6
MK 50	01.96-12.99	1	0 241 245 656	W 5 BC	0,6
MM 50	01.97-12.99	1	0 242 245 517	WR 5 AC	0,6
MY 50	01.96-12.98	1	0 242 245 517	WR 5 AC	0,6
Silver LC 50	01.96-12.98	1	0 242 250 503	WR 4 CC	0,5

BULTACO**50 cc**

Astro 50	01.98-12.03	1	0 241 256 522	W 3 CC	0,5
Lobito 50	01.98-12.03	1	0 241 256 522	W 3 CC	0,5

CAGIVA**50 cc**

Cocis 50	01.88-12.91	1	0 241 248 538	W 4 CC	0,5
K 3 50	01.91-12.92	1	0 241 248 538	W 4 CC	0,5
Prima 50	01.92-12.96	1	0 241 248 538	W 4 CC	0,5
W4 50	01.91-12.94	1	0 241 248 538	W 4 CC	0,5

CARABELA**60 cc**

Moto Pony 60 Road Racer	01.77-12.87		0 241 235 607	W 7 AC	0,7
-------------------------	-------------	--	---------------	--------	-----

CARREFOUR**50 cc**

Gap 50	01.00→	1	0 241 245 580	W 5 AC	0,5
Web 50	01.00→	1	0 241 245 580	W 5 AC	0,5

CASAL**50 cc**

M 105 50	01.92-12.00	1	0 241 260 507	W 2 AC	0,6
M 109 50	01.91-12.00	1	0 241 256 512	W 3 AC	0,6
M 140 50	01.82-12.92	1	0 241 245 580	W 5 AC	0,6
M 147 50	01.91-12.00	1	0 241 245 580	W 5 AC	0,6
M 233 50	01.90-12.00	1	0 241 248 538	W 4 CC	0,6
Super Boss K168 50	01.91-12.00	1	0 241 256 512	W 3 AC	0,6
Super Boss RE 50	01.99-12.00	1	0 241 260 507	W 2 AC	0,5





Typ



CCF

50 cc

Adly 50	01.98-12.02	1	0 241 245 656	W 5 BC	0,6
Cat 50	01.98-12.02	1	0 241 245 656	W 5 BC	0,6

CIMATTI

50 cc

Oasi	01.80-12.83	1	0 241 235 607	W 7 AC	0,5
------	-------------	---	---------------	--------	-----

CLAEYS (FLANDRIA)

50 cc

Daytona 4	10.76-10.81	1	0 241 245 580	W 5 AC	0,6
Gigi	10.76-10.81	1	0 241 235 607	W 7 AC	0,5
Imola 6	10.76-10.81	1	0 241 245 580	W 5 AC	0,6
Record Super 6	10.76-10.81	1	0 241 245 580	W 5 AC	0,6
Starline 6	10.76-10.81	1	0 241 245 580	W 5 AC	0,6
037 AF-A	10.76-10.81	1	0 241 235 607	W 7 AC	0,5

CLIPIC

50 cc

Trial 50	01.00-12.05	1	0 241 245 580	W 5 AC	0,5
----------	-------------	---	---------------	--------	-----

CPI

50 cc

Aragon Mofa 50	01.07→	1	0 241 245 656	W 5 BC	0,5
Supercross SX 50	01.03→	1	0 242 245 521	WR 5 CC	0,8
Supermoto SM 50	01.03→	1	0 242 245 521	WR 5 CC	0,8
Supermoto SMX 50	01.07→	1	0 242 250 503	WR 4 CC	0,8

DERBI

50 cc

Dirt Boy 50	01.03→	1	0 242 068 500	UR 08 CC	0,7
Dirt Kid 50	01.03→	1	0 242 068 500	UR 08 CC	0,7
DS 50	01.92-12.97	1	0 241 256 512	W 3 AC	0,6
FDS 50	01.86-12.91	1	0 241 245 580	W 5 AC	0,6
FDT 50	01.86-12.90	1	0 241 245 580	W 5 AC	0,6
Fenix 50	01.92-12.96	1	0 241 256 512	W 3 AC	0,6
GPR 50	01.03→	1	0 241 248 538	W 4 CC	0,5
GTS 50	01.86-12.91	1	0 241 245 580	W 5 AC	0,6
Naked 50	01.04→	1	0 241 248 538	W 4 CC	0,5
R 50	01.02→	1	0 241 248 538	W 4 CC	0,5
RD-2 50	01.86-12.91	1	0 241 245 580	W 5 AC	0,6
RD-2 50 Country	01.92-12.92	1	0 241 256 512	W 3 AC	0,6



Typ



Savannah	09.90-12.93	1	0 241 245 580	W 5 AC	0,6
Senda	01.95-12.05	1	0 241 256 522	W 3 CC	0,6
Senda SM 50 DRD	01.03→	1	0 241 256 522	W 3 CC	0,6
Senda SM 50 DRD Pro	01.09→	1	0 242 250 503	WR 4 CC	
Senda 50	01.94-12.95	1	0 241 248 538	W 4 CC	0,5
Senda 50 R	01.95-12.02	1	0 241 256 522	W 3 CC	0,6
SM 50 Black Edition	01.02-12.04	1	0 241 248 538	W 4 CC	0,5
SM 50 Racer	01.03-12.04	1	0 241 256 522	W 3 CC	0,6
SM 50 X-Treme	01.03→	1	0 241 256 522	W 3 CC	0,6
Urban 50	01.95→	1	0 241 256 512	W 3 AC	0,6
Variant SLE America	01.86-12.90	1	0 241 245 580	W 5 AC	0,6
Variant Sport	01.86-12.90	1	0 241 245 580	W 5 AC	0,6
Variant 50	01.90-12.91	1	0 241 245 580	W 5 AC	0,6
	01.92-12.97	1	0 241 256 512	W 3 AC	0,6
Variant 50 AC	05.03-12.06	1	0 241 256 512	W 3 AC	0,5
X-Race 50	01.03-12.07	1	0 241 248 538	W 4 CC	0,5
Yumbo FD 50	01.85-12.91	1	0 241 245 580	W 5 AC	0,6

DKW

50 cc					
Sportmofa 50	09.80-12.83	1	0 241 235 607	W 7 AC	0,5
530	09.76-12.83	1	0 241 235 607	W 7 AC	0,5
532	09.76-12.83	1	0 241 235 607	W 7 AC	0,5
533	09.76-12.83	1	0 241 235 607	W 7 AC	0,5
534	09.76-12.83	1	0 241 235 607	W 7 AC	0,5
535	09.76-12.83	1	0 241 235 607	W 7 AC	0,5

DUCSON

50 cc					
XL 50 Automatic	01.81-12.88	1	0 241 235 607	W 7 AC	0,5

EPELLA

50 cc					
Monkey 50	01.07→	1	0 242 055 501	UR 3 AC	0,7
RT 50	01.07→	1	0 242 240 561	WR 6 BC	0,7

FANTIC

50 cc					
Caballero RC	06.89-12.99	1	0 241 248 538	W 4 CC	0,5
Caballero Reg.	12.80-03.82	1	0 241 245 580	W 5 AC	0,5
Caballero Reg. Super	03.82-12.84	1	0 241 256 512	W 3 AC	0,4
Caballero Replica	01.83-12.84	1	0 241 256 512	W 3 AC	0,4
Caballero Replica 50	01.83-12.84	1	0 241 248 538	W 4 CC	0,5
Caballero RS	06.89-12.99	1	0 241 248 538	W 4 CC	0,5
Caballero 50 Reg. Casa Replica	03.82-12.84	1	0 241 256 512	W 3 AC	0,4
Caballero 50 Reg. Competizione	09.75-12.84	1	0 241 245 581	W 5 CC	0,5
Caballero 160 Reg. Casa	04.79-12.84	1	0 241 248 538	W 4 CC	0,5



◀ FANTIC

Caballero 166 Reg. Competizione	03.79-06.81	1	0 241 248 538	W 4 CC	0,5
Caballero 190 Reg. Casa	01.80-12.84	1	0 241 256 512	W 3 AC	0,4
Clan	03.81-01.85	1	0 241 235 607	W 7 AC	0,5
Fast K5	01.88-12.89		0 242 250 503	WR 4 CC	0,6
FM 190 Caballero	04.81-12.84	1	0 241 256 512	W 3 AC	0,4
FM 311 issimo	01.80-12.92	1	0 241 235 607	W 7 AC	0,5
FM 330 Trial 50	04.81-12.86	1	0 241 260 507	W 2 AC	0,5
Gran Turismo Four	12.75-12.83	1	0 241 245 580	W 5 AC	0,6
Gran Turismo Super Six	01.77-12.83	1	0 241 245 580	W 5 AC	0,6
Gran Turismo 200 Four	03.79-09.82	1	0 241 245 580	W 5 AC	0,6
Gran Turismo 220 Super Six	03.79-10.80	1	0 241 245 580	W 5 AC	0,6
Issimo	03.87-12.88	1	0 241 235 607	W 7 AC	0,5
Issimo avv. elettrico	11.83-06.86	1	0 241 245 580	W 5 AC	0,5
Issimo KS	04.84-06.86	1	0 241 235 607	W 7 AC	0,5
Issimo Sport	01.80-12.84	1	0 241 235 607	W 7 AC	0,5
Issimo 3 vel.	01.82-12.92	1	0 241 235 607	W 7 AC	0,5
Issimo 20/25 mph	01.77-06.78	1	0 241 235 607	W 7 AC	0,5
Issimo 84	04.83-12.88	1	0 241 235 607	W 7 AC	0,5
Issimo 470 3 vel.	05.81-12.88	1	0 241 235 607	W 7 AC	0,5
Koala	06.87-12.97	1	0 241 235 089	W 7 CC	0,6
Koala 50	01.88-12.98	1	0 241 248 538	W 4 CC	0,5
Lei	01.77-06.81	1	0 241 235 607	W 7 AC	0,5
Multispeed	03.87-12.87	1	0 242 245 517	WR 5 AC	0,6
Oasis 50	09.88-12.98	1	0 241 248 538	W 4 CC	0,5
Oasis 50.1	03.86-12.87	1	0 241 235 089	W 7 CC	0,6
Raider 50	04.84-02.86	1	0 241 245 581	W 5 CC	0,5
	05.85-02.86	1	0 241 235 089	W 7 CC	0,5
Raider 50.1	03.86-12.87	1	0 241 235 089	W 7 CC	0,5
Rally 320	01.80-06.81	1	0 241 235 607	W 7 AC	0,5
Sprinter	01.83-06.88	1	0 241 235 607	W 7 AC	0,5
Sprinter Multispeed	03.84-06.88	1	0 241 245 580	W 5 AC	0,6
Strada 50	01.83-12.84	1	0 241 256 512	W 3 AC	0,4
Strada 50 4 marce	05.84-12.86	1	0 241 256 512	W 3 AC	0,4
Strada 50 6 marce	04.83-12.84	1	0 241 256 512	W 3 AC	0,4
Super Rocket	10.82-12.84	1	0 242 245 517	WR 5 AC	0,5
Trial Kid 92	02.92-12.02	1	0 241 245 580	W 5 AC	0,5
Trial Matic	12.82-12.86	1	0 241 256 522	W 3 CC	0,4
Trial 50	02.79-12.85	1	0 241 245 580	W 5 AC	0,5
Trial 50 Progress	09.86-12.96	1	0 241 235 089	W 7 CC	0,6
TX 108 Super Rocket	03.79-06.82	1	0 241 245 580	W 5 AC	0,6
TX 172 Lei	01.77-07.78	1	0 241 235 607	W 7 AC	0,5
TX 174 Lei	01.77-07.78	1	0 241 235 607	W 7 AC	0,5
TX 190 Caballero	01.75-12.84	1	0 241 256 512	W 3 AC	0,4
TX 240 GT Super six	03.79-10.80	1	0 241 245 580	W 5 AC	0,6
TX 240 GT Super six codice	03.79-10.80	1	0 241 256 512	W 3 AC	0,4
TX 270 GT Four	03.79-12.81	1	0 241 256 512	W 3 AC	0,4
TX 290 Caballero Reg. 4 M	03.79-12.81	1	0 241 245 580	W 5 AC	0,6
TX 291 Caballero Reg. 6 M	03.79-06.81	1	0 241 245 580	W 5 AC	0,6
TX 320 Rally	01.77-06.81	1	0 241 235 607	W 7 AC	0,5
TX 330 Trial 50	01.79-12.86	1	0 241 256 515	W 3 CS	0,5



Typ

**GABBIANO****50 cc**

Line 1	02.79-12.89	1	0 241 235 607	W 7 AC	0,5
Okey	01.79-12.89	1	0 241 235 607	W 7 AC	0,5
P 1	12.83-12.93	1	0 241 235 607	W 7 AC	0,5
T 3 Special	01.80-01.83	1	0 241 235 607	W 7 AC	0,5
Turismo	01.81-12.83	1	0 241 235 607	W 7 AC	0,5

G.A.C.MOBYLE**50 cc**

AV 52 50 Transportino	01.76-12.81	1	0 241 235 607	W 7 AC	0,5
AV 70 E GT 50	01.75-12.83	1	0 241 235 607	W 7 AC	0,5
AV 87 50	01.75-12.87	1	0 241 235 607	W 7 AC	0,5
AV 87 50 Transport	01.83-12.91	1	0 241 245 580	W 5 AC	0,5
AV 90 Rural 50	01.88-12.95	1	0 241 245 580	W 5 AC	0,5
Cady 50	01.88-12.03	1	0 241 245 580	W 5 AC	0,5
Chopper 50	01.88-12.90	1	0 241 245 580	W 5 AC	0,5
Coma First 50	01.88-12.90	1	0 241 245 580	W 5 AC	0,5
Coma Harwar 50	01.88-12.90	1	0 241 245 580	W 5 AC	0,5
D 55 Cross 50	01.80-12.87	1	0 241 235 607	W 7 AC	0,5
D 55 Moby Cross 50	01.78-12.87	1	0 241 235 607	W 7 AC	0,5
D 55 50	01.80-12.87	1	0 241 235 607	W 7 AC	0,5
	01.88-12.95	1	0 241 245 580	W 5 AC	0,5
Kanowey 50	01.88-12.90	1	0 241 245 580	W 5 AC	0,5
Liberty 50	01.81-12.87	1	0 241 235 607	W 7 AC	0,5
MTR Top Racer 50	01.90-12.92	1	0 241 248 538	W 4 CC	0,5
Onix City 50	01.89-12.90	1	0 241 245 580	W 5 AC	0,5
Onix Coma 50	01.89-12.90	1	0 241 245 580	W 5 AC	0,5
Onix 2 50	01.87-12.89	1	0 241 245 580	W 5 AC	0,5
Onix 50	01.86-12.87	1	0 241 235 607	W 7 AC	0,5
	01.88-12.89	1	0 241 245 580	W 5 AC	0,5
SP 95 R Campera 50	01.88-12.03	1	0 241 245 580	W 5 AC	0,5
SP 96 Gran Turismo 50	01.76-12.83	1	0 241 235 607	W 7 AC	0,5
University 50	01.82-12.86	1	0 241 235 607	W 7 AC	0,5
Winner 50	01.90-12.91	1	0 241 248 538	W 4 CC	0,5
Zarpa NTT 50	01.89-12.90	1	0 241 245 580	W 5 AC	0,5

GARELLI (AGRATI-GARELLI)**50 cc**

Astro FX 50	01.00-12.06	1	0 242 268 500	WR 08 AC	0,6
Basic due SL	01.85-01.88	1	0 242 235 533	WR 7 AC	0,5
Basic Matic MK	01.85-01.88	1	0 241 245 580	W 5 AC	0,6
Basic SL	01.84-01.88	1	0 241 229 604	W 8 AC	0,5
Basic 20	01.84-12.92	1	0 242 235 533	WR 7 AC	0,5
Basic 25	01.84-12.92	1	0 242 235 533	WR 7 AC	0,5
Basic 30	01.84-12.84	1	0 242 245 517	WR 5 AC	0,5
	01.85-01.88	1	0 242 235 533	WR 7 AC	0,5
Basic 40, 40 DL	01.85-12.88	1	0 242 235 533	WR 7 AC	0,5
Big Wheel 50	01.93-12.95	1	0 242 240 561	WR 6 BC	0,6



◀ GARELLI

Bimatic	01.85-12.92	1	0 241 235 607	W 7 AC	0,5
Cross KL Matic	03.81-12.81	1	0 241 235 089	W 7 CC	0,6
Euro Automatic	01.79-12.80	1	0 241 229 604	W 8 AC	0,5
Europed 40 SL	01.76-12.80	1	0 241 229 604	W 8 AC	0,5
Flirt matic	01.88-12.88	1	0 241 235 607	W 7 AC	0,5
Flory VIP 3	01.88-12.88	1	0 241 235 607	W 7 AC	0,5
Form Uno	01.87-12.92	1	0 241 235 607	W 7 AC	0,5
Gary Uno	01.88-12.92	1	0 241 235 607	W 7 AC	0,5
Gulp Flex	01.76-12.80	1	0 241 229 604	W 8 AC	0,5
Gulp Matic	01.78-12.80	1	0 241 229 604	W 8 AC	0,5
Gulp Matic Luxus	01.76-12.80	1	0 241 229 604	W 8 AC	0,5
Gulp 3 V	01.76-12.80	1	0 241 229 604	W 8 AC	0,5
Junior Turismo	01.82-01.88	1	0 241 235 089	W 7 CC	0,6
Katia	01.78-12.81	1	0 241 245 580	W 5 AC	0,6
Katia K 2 VN	01.82-12.84	1	0 241 229 604	W 8 AC	0,5
Katia M	01.77-12.81	1	0 241 229 604	W 8 AC	0,5
Katia M, K	01.76-12.80	1	0 241 245 580	W 5 AC	0,6
Katia Matic	01.81-12.84	1	0 241 245 580	W 5 AC	0,6
Katia Matic K 2 V	01.81-12.81	1	0 241 245 580	W 5 AC	0,6
Katia MK	01.81-12.82	1	0 241 245 580	W 5 AC	0,6
Katia VN	09.81-12.84	1	0 241 229 604	W 8 AC	0,5
Katia 1 SL	04.84-12.84	1	0 241 229 604	W 8 AC	0,5
Katia 2 ES	01.82-12.84	1	0 241 229 604	W 8 AC	0,5
Katia 2 SL	06.88-12.88	1	0 241 229 604	W 8 AC	0,5
Katia 2 VNK	09.81-12.83	1	0 242 235 533	WR 7 AC	0,5
Katia 25 L	04.84-12.88	1	0 242 235 533	WR 7 AC	0,5
Mokick Cross Sport	01.76-12.78	1	0 241 235 607	W 7 AC	0,5
NOI 50	02.80-12.92	1	0 241 235 607	W 7 AC	0,5
Primo	02.80-12.82	1	0 241 245 580	W 5 AC	0,6
P-Serie	01.78-12.80	1	0 241 235 607	W 7 AC	0,5
Rally Sport	01.85-01.88	1	0 241 235 607	W 7 AC	0,5
RS Electronic	01.76-12.80	1	0 242 250 503	WR 4 CC	0,6
Sahel	01.88-12.92	1	0 241 256 522	W 3 CC	0,6
Sport 25/3	01.82-12.84	1	0 241 229 604	W 8 AC	0,5
Super VIP	01.85-12.88	1	0 241 235 607	W 7 AC	0,5
Team matic 50	03.86-12.92	1	0 241 235 607	W 7 AC	0,5
Tiger 50 XLE	03.86-12.92	1	0 241 256 522	W 3 CC	0,6
Urka AC, ES, LC, AC ES, LC ES	09.88-12.91	1	0 241 256 522	W 3 CC	0,5
VIP 1 VN	01.78-01.88	1	0 241 229 604	W 8 AC	0,6
VIP 2 V SL, SL RL	01.79-01.88	1	0 241 229 604	W 8 AC	0,5
VIP 2 VN	01.78-01.88	1	0 241 235 607	W 7 AC	0,5
VIP 3 V	01.78-01.88	1	0 241 235 607	W 7 AC	0,5
VIP 4	01.81-12.92	1	0 241 235 607	W 7 AC	0,5
VIP 25/3	01.82-12.84	1	0 241 229 604	W 8 AC	0,5

GAS-GAS

50 cc

EC 50 Boy	01.00-12.03	1	0 241 256 512	W 3 AC	0,6
EC 50 Rookie	01.00-12.03	1	0 242 255 502	WR 3 CC	0,6



Typ

**GHIARONI****50 cc**

Bimbo Bip Bip	01.80-12.83	1	0 242 235 533	WR 7 AC	0,5
Bimbo TNT	01.80-12.83	1	0 242 235 533	WR 7 AC	0,5
Brooklin	01.87-12.97	1	0 242 235 533	WR 7 AC	0,5
Brooklin SL	01.80-12.86	1	0 242 235 533	WR 7 AC	0,5
Dream	01.80-12.84	1	0 242 235 663	WR 7 DC+	0,6
New Deal	01.78-12.88	1	0 242 235 663	WR 7 DC+	0,6
Star	01.80-12.81	1	0 241 235 089	W 7 CC	0,5
Surprise	01.78-12.83	1	0 242 235 533	WR 7 AC	0,5
TNT Ritmo	01.80-12.83	1	0 242 235 533	WR 7 AC	0,5

GILERA (PIAGGIO)**50 cc**

Bullit	01.91-12.93	1	0 241 256 522	W 3 CC	0,5
CB 1	11.90-12.93	1	0 241 256 522	W 3 CC	0,5
CBA 50	01.77-12.81	1	0 241 235 607	W 7 AC	0,5
DNA 50	01.00-12.08	1	0 242 255 502	WR 3 CC	0,6
Eaglet 50	01.93-12.99	1	0 241 256 522	W 3 CC	0,5
EC 1	01.81-12.97	1	0 241 229 604	W 8 AC	0,5
ECO 50	01.79-12.85	1	0 241 235 607	W 7 AC	0,5
GSM 50	01.00-12.03	1	0 242 255 502	WR 3 CC	0,6
Rally R1	05.87-12.89	1	0 241 256 522	W 3 CC	0,5
Sioux	05.91-12.93	1	0 241 256 522	W 3 CC	0,5
Trend 50	09.88-12.91	1	0 241 229 604	W 8 AC	0,6
Trial 50	01.82-12.85	1	0 241 245 581	W 5 CC	0,5
Vale	03.81-12.87	1	0 241 256 512	W 3 AC	0,4
50 GR 2	01.77-12.84	1	0 241 235 089	W 7 CC	0,5
		1	0 241 245 581	W 5 CC	0,5
50 RC 90	03.90-12.90	1	0 241 256 522	W 3 CC	0,5
50 RS	01.75-07.80	1	0 241 235 089	W 7 CC	0,5
50 TS	01.79-12.82	1	0 241 245 581	W 5 CC	0,5
50-6 V	01.77-12.82	1	0 241 248 538	W 4 CC	0,5
503	06.91-12.93	1	0 241 256 522	W 3 CC	0,5

GIMSON**50 cc**

E87 Enduro 50	01.79-12.79	1	0 241 229 604	W 8 AC	0,5
---------------	-------------	---	---------------	--------	-----

GITAN**50 cc**

Brigand	01.82-04.85		0 241 235 607	W 7 AC	0,5
Brixia 4 S	01.75-12.81		0 241 235 607	W 7 AC	0,5
Carnaby 1	01.75-04.85	1	0 241 235 607	W 7 AC	0,5
Carnaby 1 Super	01.75-04.85	1	0 241 235 607	W 7 AC	0,5
Carnaby 3 Super	01.75-04.85		0 241 235 607	W 7 AC	0,5
Carnaby 4 R	01.75-04.85		0 241 235 607	W 7 AC	0,5



Typ



◀ GITAN

Corsa Super, Cricket	01.75-11.83		0 241 235 607	W 7 AC	0,5
Cross Junior 6 M	01.75-12.81		0 241 235 089	W 7 CC	0,5
Cross M 4	01.75-12.81		0 242 235 533	WR 7 AC	0,5
Cross 4 V	01.75-12.81		0 241 235 089	W 7 CC	0,5
Daytona	01.75-11.83		0 241 235 607	W 7 AC	0,5
Debra SK	01.75-11.83	1	0 241 235 607	W 7 AC	0,5
Dimo	01.75-11.83		0 241 235 607	W 7 AC	0,5
Flash	01.75-12.81		0 241 235 607	W 7 AC	0,5
Grand Sport Champion	01.75-11.83		0 241 235 607	W 7 AC	0,5
Holiday G 72	01.75-12.81		0 241 235 607	W 7 AC	0,5
Holiday 3 V	01.75-12.81		0 241 245 580	W 5 AC	0,6
Mini	01.75-12.81		0 241 235 607	W 7 AC	0,5
Monomatic	01.75-12.85	1	0 241 235 607	W 7 AC	0,5
Presa Diretta Lusso	01.75-12.81	1	0 241 235 607	W 7 AC	0,5
Pull	01.75-11.83		0 241 235 607	W 7 AC	0,5
Ralley Daytona	01.75-11.83		0 241 235 607	W 7 AC	0,5
Rennen Camigo TT	01.75-11.83		0 241 235 607	W 7 AC	0,5
Soleado E	01.82-04.85	1	0 241 235 607	W 7 AC	0,5
Soleado L	01.82-04.85		0 241 235 607	W 7 AC	0,5
Special M 4	01.78-12.81		0 241 235 607	W 7 AC	0,5
Special 4 R	01.82-04.85		0 241 256 522	W 3 CC	0,4
Spring 4 Lux	01.75-11.83		0 241 235 607	W 7 AC	0,5
Super Champion	01.75-11.83		0 241 235 607	W 7 AC	0,5
Super Polaris	01.75-11.83		0 241 235 607	W 7 AC	0,5
Turismo	01.75-11.83		0 241 235 607	W 7 AC	0,5

GIULIETTA

50 cc

Colorado	01.79-12.84	1	0 241 235 607	W 7 AC	0,5
	01.79-12.89	1	0 241 235 755	W 7 DC	0,6
Colorado Maxi M 101	01.82-12.92	1	0 241 235 755	W 7 DC	0,6
Cross Bimbo	01.78-12.81	1	0 241 235 607	W 7 AC	0,5
Mini V 1	01.83-12.93	1	0 241 235 607	W 7 AC	0,5
Monster 4 M	01.79-12.80	1	0 241 235 607	W 7 AC	0,5
Monster 6 M	01.79-12.80	1	0 241 235 607	W 7 AC	0,5
Nevada	01.78-12.81	1	0 241 235 607	W 7 AC	0,5
		1	0 241 235 755	W 7 DC	0,5
	01.82-12.92	1	0 241 235 755	W 7 DC	0,5
Oxford	01.78-12.81		0 241 235 607	W 7 AC	0,5
Oxford Mini Special	01.78-12.81	1	0 241 235 607	W 7 AC	0,5
Pointer Special	01.78-12.81		0 241 235 607	W 7 AC	0,5
Pointer 3 M KS	01.82-12.92		0 241 235 755	W 7 DC	0,5
Scrambler	01.78-12.81		0 241 235 607	W 7 AC	0,5
Vai	01.78-12.81	1	0 241 235 755	W 7 DC	0,5
	01.82-12.92	1	0 241 235 755	W 7 DC	0,5



Typ

**HERCULES (SACHS)****50 cc**

Optima MP 4	01.78-12.88	1	0 241 245 580	W 5 AC	0,6
Swing	01.95→	1	0 241 235 607	W 7 AC	0,4
ZX1	01.90-12.00	1	0 241 245 581	W 5 CC	0,8

HM RACING**50 cc**

Baja SX 50	01.98→	1	0 241 248 538	W 4 CC	0,5
CRX 50	01.01→	1	0 241 256 512	W 3 AC	0,5
Derapage 50	01.98→	1	0 241 248 538	W 4 CC	0,5
MX 50	01.01→	1	0 241 256 512	W 3 AC	0,5
Six 50	01.98→	1	0 241 248 538	W 4 CC	0,5

HONDA**50 cc**

CRF 50 F	01.04→	1	0 242 055 501	UR 3 AC	0,7
MB 50 F	01.79-01.83	1	0 242 260 500	WR 2 AC	0,8
MB 50 S	01.79-01.83	1	0 242 245 517	WR 5 AC	0,8
MBX 50	01.83-12.86	1	0 242 255 502	WR 3 CC	0,8
MT 50 F	01.80-12.83	1	0 242 260 500	WR 2 AC	0,7
MTX 50 R	01.83-12.97	1	0 242 250 503	WR 4 CC	0,7
MTX 50 S	01.83-12.97	1	0 242 245 517	WR 5 AC	0,7
PA 50 Camino	01.76-12.91	1	0 242 235 665	WR 7 BC+	0,7
PF 50	01.75-12.78	1	0 242 235 533	WR 7 AC	0,7
PK 50 Wallaroo	01.90-12.01	1	0 242 245 577	WR 5 BC 0	0,7
PXL 50	01.80-12.90	1	0 242 235 665	WR 7 BC+	0,7
ST 50 Dax	01.88-12.02	1	0 242 055 501	UR 3 AC	0,7
TLM 50	01.85-12.85	1	0 242 250 503	WR 4 CC	0,8
XR 50 R	01.00-12.03	1	0 242 055 501	UR 3 AC	
Z 50 Monkey	01.94-12.99	1	0 242 055 501	UR 3 AC	0,7
ZB 50 Monkey	01.88-12.91	1	0 242 055 501	UR 3 AC	0,7

HRD**50 cc**

GS Enduro 50	01.98-12.99	1	0 242 250 503	WR 4 CC	0,6
Slide Sonic SM 50	01.98-12.02	1	0 242 250 503	WR 4 CC	0,6
Sonic 2 50	01.99-12.02	1	0 242 250 503	WR 4 CC	0,6

HUSQVARNA (CAGIVA)**50 cc**

Husky boy basic	01.99→	1	0 241 256 512	W 3 AC	0,5
Husky boy junior	01.99→	1	0 241 235 607	W 7 AC	0,5
Husky boy racing	01.99→	1	0 241 235 607	W 7 AC	0,5
Husky boy senior	01.99→	1	0 241 235 607	W 7 AC	0,5



◀ HUSQVARNA

SM 50	01.02→	1	0 242 255 502	WR 3 CC	0,6
WRS 50	01.98→	1	0 242 255 502	WR 3 CC	0,6

ITALJET

50 cc

FastBoy 50	01.98→	1	0 242 245 517	WR 5 AC	0,6
T 50	01.84-12.94		0 241 245 580	W 5 AC	0,6
Tiffany 50	01.89-12.95	1	0 241 229 604	W 8 AC	0,5
Trial 50 T	01.79-12.81	1	0 241 235 089	W 7 CC	0,5

JAWA

50 cc

Betka 50	01.06→	1	0 241 056 502	U 3 AC	0,6
Mofa 25	01.77-12.87	1	0 241 245 580	W 5 AC	0,5
23 Mustang 50	01.76-12.86	1	0 241 235 607	W 7 AC	0,6
210 50	01.85-12.96	1	0 241 235 607	W 7 AC	0,5
215 50	01.86-12.96	1	0 241 235 607	W 7 AC	0,5
225	01.92-12.05	1	0 241 235 607	W 7 AC	0,5
	01.95-12.05	1	0 241 245 580	W 5 AC	0,5

JINCHENG

50 cc

JC 50 Q	01.04→	1	0 241 056 502	U 3 AC	0,6
---------	--------	---	---------------	--------	-----

KAWASAKI

50 cc

AE 50	01.80-12.82	1	0 241 235 089	W 7 CC	0,8
	01.83-12.83	1	0 241 248 538	W 4 CC	0,8
AR 50	01.80-12.82	1	0 241 235 089	W 7 CC	0,8
	01.83-12.92	1	0 241 248 538	W 4 CC	0,8
	01.93-12.97	1	0 242 250 503	WR 4 CC	0,8
AV 50	09.79-12.83	1	0 241 150 504	X 4 CC	0,7
KMX 50	01.90-12.93	1	0 242 250 503	WR 4 CC	0,8

KEEWAY

50 cc

X-Ray 50	01.07→	1	0 242 250 503	WR 4 CC	0,8
----------	--------	---	---------------	---------	-----

KREIDLER

50 cc

CM	01.76-03.78	1	0 241 235 607	W 7 AC	0,5
Flory SL	08.77-12.82	1	0 241 235 607	W 7 AC	0,4
Flory 4Takt	01.05→	1	0 241 056 502	U 3 AC	0,6



Typ



LF	01.76-03.78	1	0 241 235 607	W 7 AC	0,5
LFF	04.78-03.82	1	0 241 235 607	W 7 AC	0,5
		1	0 242 235 533	WR 7 AC	0,4
LH	01.76-03.77	1	0 241 235 607	W 7 AC	0,5
Mokick 40	01.76-03.82	1	0 241 245 581	W 5 CC	0,5
MP 3	01.76-03.82	1	0 241 235 607	W 7 AC	0,5
MP 8	01.76-03.82	1	0 241 235 607	W 7 AC	0,5
MP 9	01.76-03.82	1	0 241 235 607	W 7 AC	0,5
MP 19	01.78-03.82	1	0 241 235 607	W 7 AC	0,5
RM	01.76-03.82	1	0 241 235 607	W 7 AC	0,5
		1	0 241 256 512	W 3 AC	0,4
		1	0 241 256 522	W 3 CC	0,4
RMC	01.76-03.82	1	0 241 256 512	W 3 AC	0,4
RS Solo	01.76-03.82	1	0 241 256 512	W 3 AC	0,4
TSV 2050 Cross	01.76-03.78	1	0 241 235 607	W 7 AC	0,5
TSV 2051 RS	01.76-03.78	1	0 241 235 607	W 7 AC	0,5

KTM



50 cc					
Bora 50	01.82→	1	0 241 235 607	W 7 AC	0,6
Comet 50	09.76→	1	0 241 235 607	W 7 AC	0,6
Foxi 50	01.88-12.98	1	0 241 245 580	W 5 AC	0,6
Go 50	01.94-12.99	1	0 242 245 517	WR 5 AC	0,5
GP 50	10.81-12.91	1	0 241 245 580	W 5 AC	0,6
GXE	04.86-12.96	1	0 241 256 515	W 3 CS	0,6
Hobby E 50	10.81-12.91	1	0 241 235 755	W 7 DC	0,6
Hobby GS L 50	10.81-12.91	1	0 241 235 755	W 7 DC	0,6
Pony L 50	10.81-12.91	1	0 241 245 580	W 5 AC	0,6
Postmofa	01.85→	1	0 241 235 755	W 7 DC	0,6
Squadra	01.88→	1	0 241 235 755	W 7 DC	0,6
S5	01.99→	1	0 241 256 512	W 3 AC	0,6
50 Adventure	01.02→	1	0 242 074 501	UR 07 AC	0,7
50 Junior Adventure	01.00→	1	0 242 260 500	WR 2 AC	0,6
50 ME	10.81-12.91	1	0 241 245 580	W 5 AC	0,6
50 Mini Adventure	01.00-12.01	1	0 241 256 512	W 3 AC	0,6
	01.02→	1	0 242 260 500	WR 2 AC	0,6
50 Mini Adventure GS	01.02→	1	0 242 260 500	WR 2 AC	0,6
50 MLS	10.81-12.91	1	0 241 235 607	W 7 AC	0,6
50 MMS	10.81-12.91	1	0 241 245 580	W 5 AC	0,6
50 MS	10.81-12.91	1	0 241 235 607	W 7 AC	0,6
50 RSL	10.81-12.91	1	0 241 245 580	W 5 AC	0,6
50 Senior Adventure	01.03→	1	0 242 260 500	WR 2 AC	0,6
50 SX Junior	01.01-12.01	1	0 241 256 512	W 3 AC	0,6
	01.02→	1	0 242 274 501	WR 07 CS	0,6
50 SX Senior	01.01-12.01	1	0 241 256 512	W 3 AC	0,6
	01.02→	1	0 242 274 501	WR 07 CS	0,6
50 SXR Adventure	01.97-12.01	1	0 241 256 512	W 3 AC	0,6
50 SXR Pro Junior	01.97-12.01	1	0 241 256 512	W 3 AC	0,6
50 SXR Pro Senior	01.97-12.01	1	0 241 256 512	W 3 AC	0,6



Typ

**LAMBRETTA****50 cc**

Puma 5 V 50	01.75-12.80	1	0 241 235 607	W 7 AC	0,5
-------------	-------------	---	---------------	--------	-----

LEM MOTOR**50 cc**

Cinno Corsa 50	01.78-11.83	1	0 241 235 607	W 7 AC	0,5
Cinno Cross MX	01.82-12.92	1	0 242 235 533	WR 7 AC	0,5
CR3 50	01.96-12.02	1	0 241 245 580	W 5 AC	0,5
LX1 50	01.99-12.03	1	0 241 256 512	W 3 AC	0,6
LX2 50	01.97-12.05	1	0 241 245 580	W 5 AC	0,5
LX4 50	01.97-12.05	1	0 241 256 522	W 3 CC	0,6
L2 50	01.04-12.06	1	0 241 245 580	W 5 AC	0,5
Matic	01.78-11.83	1	0 241 235 607	W 7 AC	0,5
Safari X	01.82-12.90	1	0 242 235 533	WR 7 AC	0,5
SK 6 50	01.97-12.05	1	0 241 245 580	W 5 AC	0,5
SM 2 50	01.03-12.05	1	0 241 245 580	W 5 AC	0,5
Stratos Spec. 4 M	01.81-01.82	1	0 241 235 755	W 7 DC	0,6
2001 Matic	01.78-12.79	1	0 241 235 755	W 7 DC	0,5
2001 Variant	01.78-12.79	1	0 241 235 755	W 7 DC	0,5
2001 50	01.78-12.79	1	0 241 235 755	W 7 DC	0,5

LIFAN**50 cc**

LF 50 GY	01.03→	1	0 241 056 502	U 3 AC	0,6
LF 50 QGY	01.06→	1	0 241 056 502	U 3 AC	0,6

MACAL**50 cc**

GTX 50	01.98-12.04	1	0 242 245 517	WR 5 AC	0,6
MY 50	01.99-12.04	1	0 242 245 517	WR 5 AC	0,6
New Star 50	01.98-12.04	1	0 242 245 517	WR 5 AC	0,6
Star Flight 50	01.98-12.04	1	0 242 245 517	WR 5 AC	0,6
Trophy 50	01.98-12.04	1	0 242 250 503	WR 4 CC	0,6

MALAGUTI**50 cc**

Custom	01.81-06.86	1	0 241 235 607	W 7 AC	0,5
Drakon 50	01.07→	1	0 242 255 502	WR 3 CC	0,6
Enduro RCW	01.83-06.85	1	0 241 235 607	W 7 AC	0,5
Enduro 50 MDX	01.86-12.96		0 241 245 581	W 5 CC	0,5
Enduro 50 MEX	01.86-12.96	1	0 241 245 581	W 5 CC	0,5
Enduro 50 MFX	01.86-12.96	1	0 241 245 581	W 5 CC	0,5
Enduro 50 MGX	01.86-12.96		0 241 235 607	W 7 AC	0,5
Fifty AS Duomatik	01.75-12.79	1	0 241 235 607	W 7 AC	0,5



Typ



Fifty AS Kik M	01.78-12.82		1	0 241 235 607	W 7 AC	0,5
Fifty AS Pedali	01.78-12.82		1	0 241 235 607	W 7 AC	0,5
Fifty Black Special	01.79-11.84		1	0 241 235 607	W 7 AC	0,5
Fifty Full	01.79-12.96		1	0 241 235 607	W 7 AC	0,5
Fifty Full EX	01.79-12.85		1	0 241 235 607	W 7 AC	0,5
Fifty HF	01.79-12.82		1	0 241 235 607	W 7 AC	0,5
Fifty HF Econ.	01.79-11.84		1	0 241 235 607	W 7 AC	0,5
Fifty HF New	01.82-12.96		1	0 241 235 607	W 7 AC	0,5
Fifty HF New Mono	01.82-12.92		1	0 241 235 607	W 7 AC	0,5
Fifty Radial Econ.	01.79-12.80		1	0 241 235 607	W 7 AC	0,5
Fifty RV Variatore	01.83-12.93		1	0 241 235 607	W 7 AC	0,5
Fifty Top	01.82-12.96		1	0 241 256 522	W 3 CC	0,5
Fifty Top 10	01.96-12.06		1	0 241 256 522	W 3 CC	0,5
Fire Bird	01.80-06.84		1	0 241 235 755	W 7 DC	0,6
Fire 4 M	01.80-06.84		1	0 241 235 755	W 7 DC	0,5
Gran Turismo	01.81-12.81		1	0 241 235 607	W 7 AC	0,5
Grizzly RC	01.87→		1	0 241 235 607	W 7 AC	0,5
Grizzly RCX 10	01.87→	AG	1	0 241 235 607	W 7 AC	0,5
		GS	1	0 242 235 533	WR 7 AC	0,5
Grizzly RCX 12	01.87→	AG	1	0 241 256 512	W 3 AC	0,5
		GS	1	0 242 260 500	WR 2 AC	0,5
Grizzly 10	01.05→		1	0 241 235 607	W 7 AC	0,5
Grizzly 12 Cross	01.99→		1	0 241 256 512	W 3 AC	0,5
Grizzly 12 Supermoto	01.99→		1	0 241 245 580	W 5 AC	0,5
Haccapi	01.79-12.83		1	0 241 235 755	W 7 DC	0,6
MGX 450	09.86-12.96		1	0 241 245 581	W 5 CC	0,5
Pilot Strada	01.79-12.80		1	0 241 256 512	W 3 AC	0,4
Ronchino	01.78-12.81		1	0 241 245 580	W 5 AC	0,5
Ronchino Baby A	01.78-12.84		1	0 241 235 607	W 7 AC	0,5
Ronco 21	01.78-03.81		1	0 241 235 607	W 7 AC	0,5
Ronco 21 4,6 M	01.78-12.88		1	0 241 235 607	W 7 AC	0,5
RST	01.87-12.97		1	0 241 256 522	W 3 CC	0,5
Tre Tre	01.79-12.80		1	0 241 235 607	W 7 AC	0,5
Tre Tre 3 Marce Kik	01.75-12.82		1	0 241 235 607	W 7 AC	0,5

MALANCA

50 cc

Big	01.79-12.89		1	0 241 235 607	W 7 AC	0,5
Due Piu	01.78-12.88		1	0 241 235 607	W 7 AC	0,5
Due Piu elle	01.78-12.88		1	0 241 235 607	W 7 AC	0,5

MBK

50 cc

CF	01.85→		1	0 241 235 607	W 7 AC	0,5
Champ	01.85→		1	0 241 235 607	W 7 AC	0,5
Daytona	01.87→		1	0 241 235 607	W 7 AC	0,5
FX	01.85→		1	0 241 248 538	W 4 CC	0,5
KW Magnum	01.85→		1	0 241 235 607	W 7 AC	0,5
Monty MB3V 50	01.77-07.83		1	0 241 235 755	W 7 DC	0,5



Typ



◀ MBK

Monty SP3V 50	01.77-11.81	1	0 241 235 755	W 7 DC	0,6
	12.81→	1	0 241 235 607	W 7 AC	0,5
Rock	01.90→	1	0 241 235 607	W 7 AC	0,5
Weekly	01.85→	1	0 241 245 580	W 5 AC	0,5
X power	01.03→	1	0 242 255 502	WR 3 CC	0,8
X-Limit	01.97-12.07	1	0 242 255 502	WR 3 CC	0,7
ZX	01.80→	1	0 242 245 517	WR 5 AC	0,5
41	01.82→	1	0 241 235 607	W 7 AC	0,5
51 SU	01.81-07.83	1	0 241 235 607	W 7 AC	0,5
89	08.83→	1	0 241 235 607	W 7 AC	0,5
151	01.79-07.83	1	0 241 235 607	W 7 AC	0,5

MBM

50 cc

Amico Export Super	01.75-11.83	1	0 241 256 512	W 3 AC	0,5
Amico Special Super	01.75-11.83	1	0 241 256 512	W 3 AC	0,5

MECATECNO

50 cc

Chic 50	01.83-12.90	1	0 241 235 607	W 7 AC	0,5
Cuc 50	01.80-12.87	1	0 241 235 607	W 7 AC	0,5
Dragon Fly 50	01.90-12.93	1	0 241 235 607	W 7 AC	0,5
Funny 50	01.83-12.90	1	0 241 235 607	W 7 AC	0,5
Grac 50	01.83-12.88	1	0 241 235 607	W 7 AC	0,5
Hobby 50	01.83-12.88	1	0 241 235 607	W 7 AC	0,5
Huracan 50	01.83-12.88	1	0 241 235 607	W 7 AC	0,5
Micro GP 50	01.80-12.87	1	0 241 235 607	W 7 AC	0,5
Mini 4 50	01.80-12.87	1	0 241 235 607	W 7 AC	0,5
Racing CR 7 50	01.83-12.94	1	0 241 256 522	W 3 CC	0,5
Tanga 50	01.83-12.88	1	0 241 235 755	W 7 DC	0,5

MEGO

50 cc

GT 50	01.86-12.96	1	0 241 245 581	W 5 CC	0,5
Libra	01.86-12.96	1	0 241 235 607	W 7 AC	0,5
Neo Viva	01.86-12.96	1	0 241 235 607	W 7 AC	0,5
Viva I	01.86-12.96	1	0 241 235 607	W 7 AC	0,5
Viva II	01.86-12.96	1	0 241 235 607	W 7 AC	0,5
Viva III	01.86-12.96	1	0 241 235 607	W 7 AC	0,5

METALURGIA CASAL

50 cc

K 181	01.91-12.01	1	0 241 229 604	W 8 AC	0,5
K 554 RZ50	01.91-12.01	1	0 241 245 580	W 5 AC	0,6



Typ



MIDWEST

50 cc					
JC50Q-9	01.00→	1	0 242 055 501	UR 3 AC	0,7

MOPEX

50 cc					
S 2200 50	01.06→	1	0 242 235 533	WR 7 AC	0,7
S 3800 50	01.06→	1	0 242 235 533	WR 7 AC	0,7
S 4800 50	01.06→	1	0 242 235 533	WR 7 AC	0,7

MOTO GEROSA

50 cc					
Ciclocarro	01.77-12.87	1	0 241 235 607	W 7 AC	0,5
Cross Export	01.77-12.81	1	0 241 235 607	W 7 AC	0,5
Cross M	01.77-12.81	1	0 241 235 607	W 7 AC	0,5
Foletto 4 M	01.83-12.93	1	0 241 235 607	W 7 AC	0,5
Mini Pieghevole 50	04.79-12.79	1	0 241 235 607	W 7 AC	0,6
Monotrave L 4 M 50	01.77-12.79	1	0 241 235 089	W 7 CC	0,7
Motocarro 50	01.76-12.84	1	0 241 235 607	W 7 AC	0,6
Pulce Bimbo 50	04.77-12.81	1	0 241 235 607	W 7 AC	0,6
Pulce Junior 4 M 50	01.77-12.82	1	0 241 235 089	W 7 CC	0,7
Regularita Corsa 50 6M	01.78-12.88	1	0 241 248 538	W 4 CC	0,5
V 1 Monotrave	01.76-12.81	1	0 241 235 607	W 7 AC	0,6
V 110 50	01.76-12.84	1	0 241 235 607	W 7 AC	0,6

MOTO METEORA

50 cc					
Blitz	01.77-12.81	1	0 241 235 607	W 7 AC	0,5
Meeting	01.77-12.81	1	0 241 235 607	W 7 AC	0,5
Mini Seebring	06.82-12.92		0 241 235 607	W 7 AC	0,5
Minimet	01.75-12.85	1	0 241 235 607	W 7 AC	0,5
Scacco	12.81-12.91	1	0 241 235 755	W 7 DC	0,6
Sebring	01.85-12.95		0 241 235 755	W 7 DC	0,6
Turismo 3 M	01.78-12.85	1	0 241 235 755	W 7 DC	0,6
2001 Lusso	01.80-12.85	1	0 241 235 755	W 7 DC	0,6

MOTOBECANE

50 cc					
D 55 T-Cross	01.78-12.81	1	0 241 235 607	W 7 AC	0,5
M 3-TD	01.75-12.80	1	0 241 235 607	W 7 AC	0,5
M 7 SL	01.78-07.83	1	0 241 235 607	W 7 AC	0,5
M 11 50	01.83-12.93	1	0 242 245 517	WR 5 AC	
M 25	01.80-07.83	1	0 241 235 607	W 7 AC	0,5
Monty MB 3 V	01.77-07.83	1	0 241 235 607	W 7 AC	0,5
Monty SP 3 V	01.79-07.83	1	0 241 235 607	W 7 AC	0,5



Typ



◀ MOTOBECANE

TM 4	01.79-07.83	1	0 241 235 607	W 7 AC	0,5
51 SU	01.81-07.83	1	0 241 235 607	W 7 AC	0,5
151 L	01.79-07.83	1	0 241 235 607	W 7 AC	0,5
151 LB	01.79-07.83	1	0 241 235 607	W 7 AC	0,5
151 LC	01.79-07.83	1	0 241 235 607	W 7 AC	0,5

MOTOR HISPANIA

50 cc

Cross 50	01.87-12.92	1	0 241 235 607	W 7 AC	0,5
Furia 50	01.97→	1	0 242 255 502	WR 3 CC	0,8
GT 81	01.81-12.87	1	0 241 235 607	W 7 AC	0,5
M 80 Automatico	01.80-12.86	1	0 241 235 089	W 7 CC	0,5
Minicross 50	01.96-12.01	1	0 241 245 580	W 5 AC	0,5
Racing RX50	01.99-12.08	1	0 242 255 502	WR 3 CC	0,8
Sport 49	01.81-12.87	1	0 241 235 607	W 7 AC	0,5
Style 50	01.94-12.01	1	0 241 245 580	W 5 AC	0,5

MOTOTECHNIKA

50 cc

Motovelesiped 45	01.89→	1	0 241 235 754	W 7 BC	0,7
ZID 50	01.98→	1	0 241 245 656	W 5 BC	0,6

MOTRON

50 cc

GL 4	01.81-12.91	1	0 241 245 581	W 5 CC	0,5
Monster 4	01.77-12.84	1	0 241 245 581	W 5 CC	0,5
Monster 6	01.75-12.79	1	0 241 245 581	W 5 CC	0,5
PL	01.80-12.81	1	0 241 245 581	W 5 CC	0,5
RA SV AP	01.79-12.84	1	0 241 235 607	W 7 AC	0,4
SA	01.79-12.89	1	0 241 245 581	W 5 CC	0,5
SV 3 R	01.81-12.86	1	0 241 245 581	W 5 CC	0,5
TR 4	01.77-12.85	1	0 241 245 581	W 5 CC	0,5
TR 6	01.77-12.85	1	0 241 245 581	W 5 CC	0,5
102	01.81-12.84		0 241 245 581	W 5 CC	0,5

MTV

50 cc

50	01.80-12.87	1	0 241 229 715	W 8 DC	0,5
----	-------------	---	---------------	--------	-----

MZ (MOTORRADWERKE ZSCHOPAU)

50 cc

S 51	01.83-12.88	1	0 241 229 604	W 8 AC	0,5
------	-------------	---	---------------	--------	-----



Typ



NEGRINI

50 cc

Big 10 A	01.75-10.85	1	0 241 235 755	W 7 DC	0,6
Cross Competizione	01.78-12.81	1	0 241 235 607	W 7 AC	0,5
Cross Fuori Strada	01.79-01.80	1	0 241 256 512	W 3 AC	0,4
Cross 6 M	01.80-12.85	1	0 241 235 607	W 7 AC	0,5
Ecole	11.81-12.85	1	0 241 235 607	W 7 AC	0,5
Gioietta	01.78-12.81	1	0 241 245 580	W 5 AC	0,6
Gipsy	01.77-12.87	1	0 241 245 580	W 5 AC	0,6
Gipsy Bimbo	01.79-12.89	1	0 241 235 607	W 7 AC	0,5
Gipsy Cross	01.79-12.87	1	0 241 235 607	W 7 AC	0,5
Leproto	01.77-12.87	1	0 241 235 755	W 7 DC	0,6
Tomos Autom.	03.79-06.85	1	0 241 245 580	W 5 AC	0,6

ODYSEE

50 cc

700-Serie 710 U	09.76-06.81	1	0 242 235 533	WR 7 AC	0,5
700-Serie 712 U	09.76-06.81	1	0 242 245 517	WR 5 AC	0,5

OTTO-VERSAND

50 cc

Fashion 50	01.96→	1	0 242 255 515	WR 3 BC 0	0,6
GTX 50	01.96→	1	0 242 245 517	WR 5 AC	0,6

PERIPOLI

50 cc

Colorado	01.83-12.84	1	0 241 235 607	W 7 AC	0,5
Colorado Maxi	01.83-12.84		0 241 235 755	W 7 DC	0,6
Dai	01.85-12.95	1	0 241 235 607	W 7 AC	0,5
Mini	01.83-01.85	1	0 241 235 607	W 7 AC	0,5
Nevada	01.82-12.87	1	0 241 235 755	W 7 DC	0,6
Oxford	01.75-12.87	1	0 241 235 607	W 7 AC	0,5
Oxford Hit	01.80-12.87	1	0 241 235 607	W 7 AC	0,5
	01.88-12.98	1	0 241 235 607	W 7 AC	0,5
Oxford Red	01.80-12.87	1	0 241 235 607	W 7 AC	0,5
	01.88-12.98	1	0 241 235 607	W 7 AC	0,5
Oxford Road	01.86-12.96	1	0 242 235 533	WR 7 AC	0,5
	01.88-12.98	1	0 241 235 607	W 7 AC	0,5
Pointer	01.83-12.84	1	0 241 235 607	W 7 AC	0,5
Pointer 3 M	01.83-12.84	1	0 241 235 607	W 7 AC	0,5
Tiny	01.83-12.84	1	0 241 235 607	W 7 AC	0,5
Trasporto	01.83-12.85	1	0 241 235 607	W 7 AC	0,5
VAI	01.81-12.84	1	0 241 235 607	W 7 AC	0,5
		1	0 241 235 755	W 7 DC	0,6
	01.85-12.95	1	0 241 235 755	W 7 DC	0,6





Typ



PEUGEOT

50 cc

Fox L	01.95-12.97	1	0 241 245 580	W 5 AC	0,6
Fox LA	01.95-12.97	1	0 241 235 607	W 7 AC	0,6
GL 10	01.76-12.89	1	0 241 235 607	W 7 AC	0,5
Scoper V 50 D	06.84-06.94	1	0 241 235 607	W 7 AC	0,5
Scoper V 50 DC	06.84-06.94	1	0 241 235 607	W 7 AC	0,5
Scoper V 50 R	06.84-06.94	1	0 241 235 607	W 7 AC	0,5
SP 3A	01.95-12.04	1	0 241 256 512	W 3 AC	0,5
TLX 50	01.79-12.85	1	0 241 235 607	W 7 AC	0,5
Vogue	01.93-12.02	1	0 241 260 507	W 2 AC	0,5
XR6 50	01.07→	1	0 242 255 502	WR 3 CC	
XR7 50	01.08→	1	0 242 255 502	WR 3 CC	
103 CRX	01.85→	1	0 241 256 512	W 3 AC	0,5
103 LC	01.80→	1	0 241 248 538	W 4 CC	0,5
103 LSM-D	06.82-06.92	1	0 241 235 607	W 7 AC	0,5
103 SP	01.86→	1	0 241 256 512	W 3 AC	0,5
103 SPM-D	04.75-04.85	1	0 241 235 607	W 7 AC	0,5
103 XP	01.86→	1	0 241 248 538	W 4 CC	0,5

PGO

50 cc

Big Max Sport 50	01.96→	1	0 241 245 656	W 5 BC	0,6
Big Max 50	01.95-12.02	1	0 242 240 561	WR 6 BC	0,5
Comet 50	01.95-12.97	1	0 241 245 656	W 5 BC	0,6
Galaxy 50	01.93-12.99	1	0 241 245 656	W 5 BC	0,6
G-Max 50	01.05→	1	0 242 240 561	WR 6 BC	0,6
Mega 50	09.96-12.05	1	0 242 240 561	WR 6 BC	0,5
PM-S 50	01.96-12.06	1	0 241 245 656	W 5 BC	0,6
PM-X 50	01.96-12.06	1	0 241 245 656	W 5 BC	0,6
RodoShow 50	01.00→	1	0 241 245 656	W 5 BC	0,6
Star 2	01.94→	1	0 241 245 656	W 5 BC	0,6
Star 50	01.93-12.03	1	0 241 235 754	W 7 BC	0,6
Tornado 50	01.97→	1	0 242 240 561	WR 6 BC	0,5
T-Rex 50	01.99-12.09	1	0 241 245 656	W 5 BC	0,6
TR-3 50	01.03→	1	0 241 245 656	W 5 BC	0,5

PIAGGIO

50 cc

Fly 50 2T	01.04-12.09	1	0 242 255 502	WR 3 CC	0,6	
	01.10→	1	0 242 250 503	WR 4 CC	0,6	
Fly 50 4T	01.05→	1	0 242 065 500	UR 09 CC		
Typhoon TPH 50	01.96-12.99	1	0 242 255 502	WR 3 CC	0,7	
Velofax 50	01.96-12.00	1	0 241 248 538	W 4 CC	0,5	
Vespa 50 Ciao Porter	01.80-12.89	1	0 241 229 604	W 8 AC	0,5	
Vespa 50 S Automatic	01.85-12.90	1	0 241 235 607	W 7 AC	0,5	
Vespa 50 SI	01.78-12.90	TW	1	0 241 235 607	W 7 AC	0,5



Typ



POLINI

50 cc

Steel 910 GP	01.00-12.06	1	0 241 235 607	W 7 AC	0,6
--------------	-------------	---	---------------	--------	-----

PUCH (STEYR-DAIMLER-PUCH AG)

50 cc

Cobra GT	01.76-12.80	1	0 241 256 512	W 3 AC	0,5
	01.81-12.81	1	0 241 260 507	W 2 AC	0,5
Cobra GTL	01.78-12.80	1	0 241 256 512	W 3 AC	0,5
	01.81-12.88	1	0 241 260 507	W 2 AC	0,5
Cobra GTS	01.77-12.80	1	0 241 256 512	W 3 AC	0,5
	01.81-12.87	1	0 241 260 507	W 2 AC	0,5
Maxi	03.77-12.82	1	0 241 229 604	W 8 AC	0,5
Maxi B	03.77-12.82	1	0 241 229 604	W 8 AC	0,5
Maxi GN	03.77-12.82	1	0 241 229 604	W 8 AC	0,5
Maxi M	03.77-12.82	1	0 241 229 604	W 8 AC	0,5
Maxi N	01.76-12.82	1	0 241 229 604	W 8 AC	0,5
Maxi Newport	09.78-12.82	1	0 242 245 517	WR 5 AC	0,5
Maxi Newport Grande	01.78-12.82	1	0 241 229 604	W 8 AC	0,5
Maxi Plus	08.82-12.92	1	0 241 229 579	W 8 CC	0,5
Maxi S	01.76-12.82	1	0 241 229 604	W 8 AC	0,5
	03.77-12.83	1	0 242 245 517	WR 5 AC	0,5
Maxi S 2	09.78-12.83	1	0 242 245 517	WR 5 AC	0,5
Maxi Sport	01.78-12.82	1	0 241 229 604	W 8 AC	0,5
Mini Maxi	08.82-12.92	1	0 241 229 579	W 8 CC	0,5
Monza 4 SG	03.77-12.80	1	0 242 245 517	WR 5 AC	0,5
MV 50 2	01.76-09.80	1	0 242 245 517	WR 5 AC	0,5
MV 50 3	01.76-09.80	1	0 242 245 517	WR 5 AC	0,5
N 50 4 Monza	06.75-12.82	1	0 242 245 517	WR 5 AC	0,5
Racing 25	09.85-12.95	1	0 242 235 533	WR 7 AC	0,5
X 50	09.80-12.82	1	0 242 245 517	WR 5 AC	0,5
X 50 3	09.78-12.82	1	0 241 245 580	W 5 AC	0,5

RIEJU

50 cc

Drac 50	01.96→	1	0 242 250 503	WR 4 CC	0,6
Euro 50	01.02→	1	0 242 255 502	WR 3 CC	0,6
MRX 50	01.02-12.05	1	0 242 250 503	WR 4 CC	0,7
MRX 50 Euro	01.04→	1	0 242 255 502	WR 3 CC	0,6
MRX 50 Top	01.04→	1	0 242 255 502	WR 3 CC	0,6
MX 50	01.00→	1	0 241 235 607	W 7 AC	0,5
MX 50 Infantil	01.01-12.01	1	0 241 235 607	W 7 AC	0,5
NKD 50	01.03→	1	0 242 255 502	WR 3 CC	0,6
NKD 50 RS 2 Naked	01.03→	1	0 242 250 503	WR 4 CC	0,7
RR 50	01.97→	1	0 242 250 503	WR 4 CC	0,6
RR 50 Castrol	01.02→	1	0 242 255 502	WR 3 CC	0,6
RR 50 Spezial Edition	01.02→	1	0 242 250 503	WR 4 CC	0,7
RS 1	01.97-12.04	1	0 242 250 503	WR 4 CC	0,7
RS 1 EVO	01.98→	1	0 242 250 503	WR 4 CC	0,6



Zyl.



Typ



◀ RIEJU

RS 1 Evo Racing	01.02→	1	0 242 255 502	WR 3 CC	0,6
RS 2	01.03→	1	0 242 250 503	WR 4 CC	0,7
RS 2 Matrix 50	01.03→	1	0 242 255 502	WR 3 CC	0,6
SMX 50	01.03→	1	0 242 250 503	WR 4 CC	0,7
SMX 50 Supermotard (EURO)	01.02→	1	0 242 255 502	WR 3 CC	0,6
Spike 50	01.02→	1	0 242 250 503	WR 4 CC	0,7
Windy	01.92→	1	0 242 245 517	WR 5 AC	0,5

RIXE

50 cc

High-Sport	09.76-12.88	1	0 241 235 607	W 7 AC	0,6
R 503	09.78-12.88	1	0 241 235 607	W 7 AC	0,6
R 504	09.79-12.89	1	0 241 245 580	W 5 AC	0,5
RS 50 B	09.78-12.82	1	0 241 235 607	W 7 AC	0,6
RS 50 S	09.76-12.82	1	0 241 256 512	W 3 AC	0,5
Tourismo E 21 EL	09.76-12.86	1	0 241 235 607	W 7 AC	0,6
Tourismo ELS	09.76-12.86	1	0 241 235 607	W 7 AC	0,6
Tourismo SL 40	09.78-12.82	1	0 241 235 607	W 7 AC	0,6

RIZZATO

50 cc

Atala Idea WOW 2M	06.86-12.96	1	0 241 235 607	W 7 AC	0,6
Califfo Matic 121 50	01.77-12.83	1	0 241 235 607	W 7 AC	0,6
Califfone Piu	03.83-12.93	1	0 241 235 607	W 7 AC	0,5
Hydro	06.86-12.96	1	0 241 245 581	W 5 CC	0,6
Master 4 MLF	06.85-12.88	1	0 241 245 581	W 5 CC	0,6
Master 4 MLL	06.85-12.88	1	0 241 245 581	W 5 CC	0,6
Super Luxe 73	06.82-01.83	1	0 241 235 607	W 7 AC	0,6

SACHS (FICHTEL & SACHS AG)

50 cc

Enduro ZX 50	01.95→	1	0 242 250 503	WR 4 CC	0,5
Jogging 50	01.84-12.95	1	0 241 235 607	W 7 AC	0,5
KX 50	01.86-12.92	1	0 241 245 656	W 5 BC	0,5
	01.93-12.98	1	0 241 235 607	W 7 AC	0,5
MK 1S 50	01.78-08.80	1	0 241 235 607	W 7 AC	0,5
MK 2S 50	01.78-08.80	1	0 241 235 607	W 7 AC	0,5
MX1 50	01.97→	1	0 241 235 607	W 7 AC	0,5
Optima 3 50	01.78→	1	0 241 235 607	W 7 AC	0,5
Optima 50	01.95→	1	0 242 260 500	WR 2 AC	0,5
Prima GT 50	01.78-12.88	1	0 241 235 607	W 7 AC	0,5
Prima GX 50	01.78-12.88	1	0 241 235 607	W 7 AC	0,5
Prima G3 50	01.78-12.88	1	0 241 235 607	W 7 AC	0,5
Prima LN	01.78→	1	0 241 235 607	W 7 AC	0,5
Prima Presto 50	01.81-12.83	1	0 241 235 607	W 7 AC	0,5
Prima Pronto 50	01.81-12.83	1	0 241 235 607	W 7 AC	0,5
Prima S 50	09.90-12.90	1	0 241 235 607	W 7 AC	0,5
Prima 3 50	01.78-12.88	1	0 241 235 607	W 7 AC	0,5
Prima 4 Low Noise 50	10.87-12.97	1	0 241 235 607	W 7 AC	0,5



Typ



Prima 4 SL 50	01.81-12.89	1	0 241 235 607	W 7 AC	0,5
Prima 4 50	01.78-12.89	1	0 241 235 607	W 7 AC	0,5
Prima 5 Low Noise 50	01.88-12.98	1	0 241 235 607	W 7 AC	0,5
Prima 5 S 50	01.78-12.88	1	0 241 235 607	W 7 AC	0,5
Prima 5 SE 50	01.78-12.88	1	0 241 235 607	W 7 AC	0,5
Prima 5 SL 50	01.81-12.89	1	0 241 235 607	W 7 AC	0,5
Prima 5 50	01.78-12.88	1	0 241 235 607	W 7 AC	0,5
Prima 6 50	01.78-12.88	1	0 241 235 607	W 7 AC	0,5
Supra Enduro 50	03.80-12.90	1	0 241 235 607	W 7 AC	0,5
Supra 2D 50	06.80-12.90	1	0 241 235 607	W 7 AC	0,5
Supra 3D 50	01.86-12.98	1	0 241 235 607	W 7 AC	0,5
Supra 4 50	06.78-12.88	1	0 241 245 580	W 5 AC	0,5
Supra 4GP 50	01.80-12.90	1	0 241 235 607	W 7 AC	0,5
XE 5 50	01.86-12.96	1	0 241 245 656	W 5 BC	0,5

SASY

50 cc					
JC 50	01.96→	1	0 241 056 502	U 3 AC	0,6

SHERCO

50 cc					
Enduro 50	01.02-12.07	1	0 242 250 503	WR 4 CC	0,5
	01.08→	1	0 242 255 502	WR 3 CC	0,6
Supermotard 50	01.02-12.07	1	0 242 250 503	WR 4 CC	0,5
	01.08→	1	0 242 255 502	WR 3 CC	0,6

SIMONINI IMEA

50 cc					
Speedy 2 Morini	01.80-12.81	1	0 241 245 580	W 5 AC	0,5

SIMSON

50 cc					
Albatros SD 50	01.97-12.02	1	0 241 256 512	W 3 AC	0,4
AT 50	09.90-12.00	1	0 241 256 512	W 3 AC	0,6
Bunny	01.87-12.90	1	0 241 256 512	W 3 AC	0,6
Habicht 25	01.96-12.02	1	0 241 256 512	W 3 AC	0,4
Habicht 50	01.96-12.02	1	0 241 256 512	W 3 AC	0,4
S 50 B 1	01.75-12.80	1	0 241 256 512	W 3 AC	0,6
S 51 B 2-4	01.82-12.90	1	0 241 256 512	W 3 AC	0,6
S 51 Enduro	01.81-12.90	1	0 241 256 512	W 3 AC	0,6
S 53	09.90-11.94	1	0 241 256 512	W 3 AC	0,6
S 53 B	01.95-12.02	1	0 241 256 512	W 3 AC	0,6
S 53 beta	01.95-12.02	1	0 241 256 512	W 3 AC	0,6
S 53 CX	01.93-12.94	1	0 241 256 512	W 3 AC	0,5
S 53 OR	01.93-12.94	1	0 241 256 512	W 3 AC	0,5
Sperber 50	01.96-12.02	1	0 241 256 512	W 3 AC	0,4
SR 50	01.85-12.90	1	0 241 256 512	W 3 AC	0,6



Typ



◀ SIMSON

SR 50 CC	01.93-12.03	1	0 241 256 512	W 3 AC	0,6
SR 50 CCE	01.93-12.03	1	0 241 256 512	W 3 AC	0,6
SR 50 XC	06.93-12.03	1	0 241 256 512	W 3 AC	0,6
SR 50 XCE	06.93-12.03	1	0 241 256 512	W 3 AC	0,6
SR 50 XG	06.93-12.03	1	0 241 256 512	W 3 AC	0,6
SR 50 1B	09.90-12.01	1	0 241 256 512	W 3 AC	0,6
SR 50 1C	09.90-12.01	1	0 241 256 512	W 3 AC	0,6
SR 50 1CE	09.90-12.01	1	0 241 256 512	W 3 AC	0,6
SR 50/1 XC	01.95-12.02	1	0 241 256 512	W 3 AC	0,6
SR 50/1 XCE	01.95-12.02	1	0 241 256 512	W 3 AC	0,6
SR 50/1 XG	01.95-12.02	1	0 241 256 512	W 3 AC	0,6
SR 50/1 XGE	01.95-12.02	1	0 241 256 512	W 3 AC	0,6
SR 53-50 alpha B	01.95-12.02	1	0 241 256 512	W 3 AC	0,5
SR 53-50 alpha C	01.95-12.02	1	0 241 256 512	W 3 AC	0,5

SOLO

50 cc

Mars Komfort 25 Luxus	03.80-12.90	1	0 241 235 607	W 7 AC	0,5
Mars Super Luxus 40	03.78-12.88	1	0 241 245 580	W 5 AC	0,6
MK 40	03.79-12.89	1	0 241 245 580	W 5 AC	0,6
MS 40	03.79-12.89	1	0 241 245 580	W 5 AC	0,6
712	01.75-02.80	1	0 242 235 533	WR 7 AC	0,7
712 Super Luxus	03.80-12.90	1	0 242 235 533	WR 7 AC	0,7
713	01.75-02.78	1	0 242 245 517	WR 5 AC	0,7
	01.93-12.94	1	0 242 245 517	WR 5 AC	0,7
713 Super Luxus	03.78-12.88	1	0 242 245 517	WR 5 AC	0,7
722	01.94→	1	0 242 235 533	WR 7 AC	0,7
723	01.94→	1	0 242 245 517	WR 5 AC	0,7
725	01.76-02.77	1	0 241 235 607	W 7 AC	0,5
725 Mini-Bike	03.77-12.82	1	0 241 235 607	W 7 AC	0,5
726	01.76-02.77	1	0 241 245 580	W 5 AC	0,6
726 Mini-Bike	03.77-12.82	1	0 241 245 580	W 5 AC	0,6
731 D	03.80-12.82	1	0 241 245 580	W 5 AC	0,6
731 Sport	03.78-12.82	1	0 241 235 607	W 7 AC	0,5
732 Sport	03.78-12.82	1	0 241 245 580	W 5 AC	0,6

SPARTA

50 cc

Buddy 50	01.78-12.79	1	0 241 235 607	W 7 AC	0,6
Happy 50	01.78-12.81	1	0 241 235 607	W 7 AC	0,6
Lucky 50	01.78-12.79	1	0 241 235 607	W 7 AC	0,6
Rocky	01.78-12.81	1	0 241 235 607	W 7 AC	0,5

STEYR (STEYR-DAIMLER-PUCH AG)

50 cc

Cobra GT	01.77-12.80	1	0 241 256 512	W 3 AC	0,5
	01.81-12.81	1	0 241 260 507	W 2 AC	0,5
Cobra GTL	01.78-12.80	1	0 241 256 512	W 3 AC	0,5
	01.81-12.81	1	0 241 260 507	W 2 AC	0,5



Typ



Cobra GTS	01.77-12.80	1	0 241 256 512	W 3 AC	0,5
	01.81-12.87	1	0 241 260 507	W 2 AC	0,5
Crazy Horse	09.78-12.79	1	0 241 235 607	W 7 AC	0,5
Magnum XK	09.78-12.82	1	0 241 229 604	W 8 AC	0,5
Maxi	03.77-12.87	1	0 241 235 607	W 7 AC	0,5
Maxi B	03.77-12.82	1	0 241 235 607	W 7 AC	0,5
Maxi Executive	03.77-12.82	1	0 241 235 607	W 7 AC	0,5
Maxi GN	03.77-12.82	1	0 241 235 607	W 7 AC	0,5
Maxi L	07.78-12.85	1	0 241 245 580	W 5 AC	0,6
Maxi M	03.77-12.82	1	0 241 235 607	W 7 AC	0,5
Maxi N	01.76-12.82	1	0 241 235 607	W 7 AC	0,5
Maxi Newport	09.78-12.82	1	0 241 245 580	W 5 AC	0,6
Maxi Newport Grande	01.78-12.82	1	0 241 235 607	W 7 AC	0,5
Maxi Quickly	09.78-12.82	1	0 241 235 607	W 7 AC	0,5
Maxi Rival	03.77-12.82	1	0 241 235 607	W 7 AC	0,5
Maxi S L2	09.78-12.81	1	0 241 235 607	W 7 AC	0,5
Maxi S 2	09.78-12.82	1	0 241 235 607	W 7 AC	0,5
	09.78-12.83	1	0 241 245 580	W 5 AC	0,6
Maxi Sport	03.77-12.82	1	0 241 235 607	W 7 AC	0,5
	01.78-12.82	1	0 241 235 607	W 7 AC	0,5
Monza GP	09.78-12.81	1	0 241 235 607	W 7 AC	0,5
Monza Nevada	09.78-12.81	1	0 241 235 607	W 7 AC	0,5
Monza 4 C	03.77-12.81	1	0 241 235 607	W 7 AC	0,5
Monza 4 SG	03.77-12.80	1	0 241 245 580	W 5 AC	0,5
Monza 4 SL	03.77-12.81	1	0 241 235 607	W 7 AC	0,5
Monza 4 SZ	09.78-12.81	1	0 241 235 607	W 7 AC	0,5
MV 50 2	01.76-09.80	1	0 241 245 580	W 5 AC	0,6
MV 50 3	01.76-09.80	1	0 241 245 580	W 5 AC	0,6
MV 50 3 X	01.76-09.80	1	0 241 235 607	W 7 AC	0,5
N 50 4 Monza	06.75-12.82	1	0 241 235 607	W 7 AC	0,5
		1	0 241 245 580	W 5 AC	0,6
N 50 6	01.76-12.79	1	0 241 245 580	W 5 AC	0,6
Newport L	09.78-12.82	1	0 241 235 607	W 7 AC	0,5
Sport MK 2	09.78-12.82	1	0 241 235 607	W 7 AC	0,5
X 50	09.80-12.82	1	0 241 245 580	W 5 AC	0,5
X 50 3	09.78-12.82	1	0 241 245 580	W 5 AC	0,5
X 50 3 Standard	01.87-12.97	1	0 241 245 580	W 5 AC	0,5

SUZUKI

50 cc

A 50 K	01.77→	1	0 242 260 500	WR 2 AC	0,7
AE 50	01.90-12.97	1	0 242 235 665	WR 7 BC+	0,7
CX 50	01.84→	1	0 242 235 665	WR 7 BC+	0,7
CY 50	01.85→	1	0 242 235 665	WR 7 BC+	0,7
DM 50	01.80→	1	0 241 235 754	W 7 BC	0,7
DR 50 Big	01.89-12.99	1	0 242 245 517	WR 5 AC	0,7
DV 50	01.80→	1	0 241 235 755	W 7 DC	0,7
GT 50	01.77-12.87	1	0 241 235 754	W 7 BC	0,7
Maxi 50	01.90→	1	0 241 245 580	W 5 AC	0,6
OR 50	01.79-12.80	1	0 241 235 754	W 7 BC	0,7
RM 50	01.80-12.89	1	0 241 245 580	W 5 AC	0,7
	01.90→	1	0 242 245 517	WR 5 AC	0,7
RV 50	01.77-12.84	1	0 241 235 754	W 7 BC	0,7



Typ



◀ SUZUKI

Suzy	01.95→	1	0 242 235 665	WR 7 BC+	0,7
TR 50 S Streetmagic	01.98-12.00	1	0 242 235 665	WR 7 BC+	0,7
TS 50 ER	01.81-12.84	1	0 241 235 754	W 7 BC	0,7
TS 50 XA	01.91-12.91	1	0 242 235 665	WR 7 BC+	0,6
TS 50 XK	08.87-12.90	1	0 241 235 755	W 7 DC	0,7
	08.91-12.02	1	0 241 235 755	W 7 DC	0,7
TS 50 XR	01.81-12.84	1	0 242 235 665	WR 7 BC+	0,8
TS 50 12,7mm	01.81→	1	0 241 235 754	W 7 BC	0,7
TS 50 19mm	01.81→	1	0 241 235 755	W 7 DC	0,8
ZR 50	01.81-12.87	1	0 241 235 755	W 7 DC	0,8

SWM

50 cc

Mini Cross 50	01.79-12.89	1	0 241 229 604	W 8 AC	0,5
---------------	-------------	---	---------------	--------	-----

SYM

50 cc

Bullet 50	01.91→	1	0 242 255 515	WR 3 BC 0	0,6
City Hopper	01.98-12.02	1	0 242 255 515	WR 3 BC 0	0,6
Fiddle 50	01.99-12.05	1	0 242 255 515	WR 3 BC 0	0,6
Jet 50	01.97→	1	0 242 255 515	WR 3 BC 0	0,6
Jet 50 Basi-X 50	01.08→	1	0 242 255 515	WR 3 BC 0	0,6
Jet 50 Euro-X 50	01.04→	1	0 242 255 515	WR 3 BC 0	0,6
Jungle 50	01.98-12.02	1	0 242 255 515	WR 3 BC 0	0,6

TESTI

50 cc

Carabo	01.75-12.77	1	0 241 235 607	W 7 AC	0,6
Champion	01.75-12.81	1	0 241 235 089	W 7 CC	0,7
		1	0 241 235 607	W 7 AC	0,6
	01.77-12.81	1	0 241 235 089	W 7 CC	0,7
Champion Special	01.75-12.81	1	0 241 235 607	W 7 AC	0,6
	01.77-12.81	1	0 241 235 089	W 7 CC	0,7
Confort	01.75-12.81	1	0 241 235 607	W 7 AC	0,6
Cricket	01.75-12.81	1	0 241 235 089	W 7 CC	0,7
		1	0 241 235 607	W 7 AC	0,6
	01.77-01.81	1	0 241 235 089	W 7 CC	0,7
	11.77-11.83	1	0 241 235 607	W 7 AC	0,5
Grand Prix 50	01.78-12.81	1	0 241 235 607	W 7 AC	0,6
Jeans	01.77-12.83	1	0 241 235 089	W 7 CC	0,7
Militar	01.77-11.83	1	0 241 245 580	W 5 AC	0,5
	01.81-11.83	1	0 241 235 607	W 7 AC	0,6
Monocross	01.78-11.83	1	0 241 235 089	W 7 CC	0,5
Monocross Reg.	01.79-11.83	1	0 241 235 089	W 7 CC	0,5
OK	01.81-12.91	1	0 241 235 607	W 7 AC	0,5



Typ



TGB

50 cc

Ergon 50	01.98→	1	0 242 240 561	WR 6 BC	0,8
202T 50	01.98→	1	0 242 240 561	WR 6 BC	0,8

TOMOS

50 cc

AT 50	01.84-12.94	1	0 241 245 580	W 5 AC	0,6
Mini B 1	09.78-12.88	1	0 241 245 580	W 5 AC	0,6
Quadro 25	01.92→	1	0 241 235 607	W 7 AC	0,6
Sport R 50	01.09→	1	0 241 235 607	W 7 AC	
Youngst R	01.09→	1	0 242 250 503	WR 4 CC	

YAMAHA

50 cc

DT 50	01.03-12.06	1	0 242 255 502	WR 3 CC	0,8
	01.07→	1	0 242 065 500	UR 09 CC	0,7
DT 50 E	01.93-12.03	1	0 242 250 503	WR 4 CC	0,7
DT 50 F	01.94-12.04	1	0 242 250 503	WR 4 CC	0,8
DT 50 LC	01.93-12.02	1	0 242 250 503	WR 4 CC	0,7
DT 50 M	01.78-12.85	1	0 241 235 607	W 7 AC	0,7
	01.86-12.89	1	0 241 235 607	W 7 AC	0,7
		1	0 241 256 512	W 3 AC	0,7
		1	0 242 235 533	WR 7 AC	0,7
		1	0 242 245 517	WR 5 AC	0,7
DT 50 MX	01.80-12.85	1	0 241 245 580	W 5 AC	0,8
	01.86-12.95	1	0 242 235 533	WR 7 AC	0,7
DT 50 R	01.89-12.96	1	0 242 245 517	WR 5 AC	0,7
	01.97-12.02	1	0 242 250 503	WR 4 CC	0,8
DX 50	01.92-12.96	1	0 242 245 517	WR 5 AC	0,7
	01.97-12.02	1	0 242 250 503	WR 4 CC	0,8
FS 1 DX	01.76-12.80	1	0 242 235 533	WR 7 AC	0,7
FS-1 50	01.87-12.91	1	0 242 245 517	WR 5 AC	0,6
LB 2M Chappy	01.75-12.80	1	0 241 235 607	W 7 AC	0,7
	01.81-12.84	1	0 241 235 754	W 7 BC	0,7
LB 3M Bop	01.78-12.84	1	0 241 235 754	W 7 BC	0,7
MS 50	01.85-12.87	1	0 242 235 665	WR 7 BC+	0,6
RD 50 MX	01.77-12.84	1	0 241 235 607	W 7 AC	0,7
SG 50 Sting	01.84-12.94	1	0 242 235 665	WR 7 BC+	0,7
TTR 50	01.03→	1	0 242 065 501	UR 09 AC	
TY 50	01.76-12.81	1	0 241 235 607	W 7 AC	0,7
TZR 50	01.03-12.06	1	0 242 255 502	WR 3 CC	0,8
	01.07→	1	0 242 065 500	UR 09 CC	
V 50	01.81-12.83	1	0 241 235 754	W 7 BC	0,7
	01.93-12.96	1	0 241 245 580	W 5 AC	0,7
YB 50	01.97-12.05	1	0 241 245 580	W 5 AC	0,7
YZ 50	01.80-12.83	1	0 241 256 522	W 3 CC	0,8



Typ



ZUENDAPP

50 cc

CS 25	09.79-12.84	1	0 241 229 715	W 8 DC	0,7
CS 50	01.79-12.85	1	0 241 229 715	W 8 DC	0,7
CX 25	06.82-12.84	1	0 241 229 715	W 8 DC	0,5
GTS 50	07.79-12.84	1	0 241 229 715	W 8 DC	0,7
Hai 25	06.80-05.82	1	0 241 229 715	W 8 DC	0,7
Hai 50	10.80-08.82	1	0 241 235 755	W 7 DC	0,6
ZA 25	09.79-12.84	1	0 241 229 604	W 8 AC	0,5
ZA 40	09.79-12.84	1	0 241 235 607	W 7 AC	0,6
ZB 22	09.78-07.80	1	0 241 229 604	W 8 AC	0,5
ZD 10	09.76-08.80	1	0 241 229 604	W 8 AC	0,5
ZD 20	09.76-12.81	1	0 241 229 604	W 8 AC	0,5
ZD 25 TS	09.76-07.80	1	0 241 229 604	W 8 AC	0,5
ZD 30	09.77-08.79	1	0 241 235 607	W 7 AC	0,5
ZD 40	09.81-05.82	1	0 241 235 755	W 7 DC	0,5
ZD 50 TS	09.78-07.80	1	0 241 229 604	W 8 AC	0,5
ZD 80/40	09.76-05.82	1	0 241 235 607	W 7 AC	0,6
ZE 40	06.82-12.84	1	0 241 229 715	W 8 DC	0,5
ZL 25	09.80-12.84	1	0 241 229 715	W 8 DC	0,7
ZR 10	09.76-07.80	1	0 241 229 604	W 8 AC	0,5
ZR 20	09.76-07.80	1	0 241 229 604	W 8 AC	0,5
ZR 30	06.77-12.80	1	0 241 235 607	W 7 AC	0,6
ZS 25	09.81-12.84	1	0 241 229 715	W 8 DC	0,5
ZX 25	09.79-08.81	1	0 241 235 607	W 7 AC	0,5
	09.81-12.84	1	0 241 229 715	W 8 DC	0,5





Typ



AIM

100 cc					
Enduro Sachs 100	12.79-05.81		0 241 260 507	W 2 AC	0,6
125 cc					
Enduro Sachs 125	12.79-05.81		0 241 260 507	W 2 AC	0,6

AJP

125 cc					
Enduro 125	01.03→	1	0 242 160 503	XR 2 CE 0	0,8
Supermoto 125	01.03→	1	0 242 160 503	XR 2 CE 0	0,8
200 cc					
Enduro 200	01.03→	1	0 242 160 503	XR 2 CE 0	0,8
Supermoto 200	01.03→	1	0 242 160 503	XR 2 CE 0	0,8
250 cc					
P 250 Cross	01.04→	1	0 242 065 500	UR 09 CC	0,6

ALFER

125 cc					
VRE 125 No Limits	01.97→	1	0 242 068 500	UR 08 CC	0,7
250 cc					
EGR 250	01.80-12.90	1	0 241 248 538	W 4 CC	0,5
VR 250	01.97→	1	0 242 250 503	WR 4 CC	0,8
300 cc					
AR 1	01.80→	1	0 241 248 538	W 4 CC	0,5
GR 300 Aqua	01.88→	1	0 241 248 538	W 4 CC	0,5
TX 300	01.90→	1	0 241 248 538	W 4 CC	0,5

AMERICAN IRON HORSE

1600 cc					
Bandit 1600	01.99-12.02	2	0 242 229 687	WR 8 DCX+	1,0
Classic 1600	01.99-12.02	2	0 242 229 687	WR 8 DCX+	1,0
Legend 1600	01.99-12.02	2	0 242 229 687	WR 8 DCX+	1,0
Outlaw 1600	01.99-12.02	2	0 242 229 687	WR 8 DCX+	1,0
Slammer 1600	01.99-12.02	2	0 242 229 687	WR 8 DCX+	1,0
Stalker 1600	01.99-12.02	2	0 242 229 687	WR 8 DCX+	1,0
Thunder 1600	01.99-12.02	2	0 242 229 687	WR 8 DCX+	1,0
1750 cc					
Bandit 1750	01.99-12.03	2	0 242 229 687	WR 8 DCX+	1,0
Classic 1750	01.99-12.03	2	0 242 229 687	WR 8 DCX+	1,0
Legend 1750	01.99-12.03	2	0 242 229 687	WR 8 DCX+	1,0
Outlaw 1750	01.99-12.03	2	0 242 229 687	WR 8 DCX+	1,0
Slammer 1750	01.99-12.03	2	0 242 229 687	WR 8 DCX+	1,0
Stalker 1750	01.99-12.03	2	0 242 229 687	WR 8 DCX+	1,0
Thunder 1750	01.99-12.03	2	0 242 229 687	WR 8 DCX+	1,0
1800 cc					
Legend 1800	01.04→	2	0 242 135 515	YR 7 DC+	1,0
LSC 1800	01.04→	2	0 242 135 515	YR 7 DC+	1,0





◀ AMERICAN IRON HORSE

Outlaw 1800	01.04→	2	0 242 135 515	YR 7 DC+	1,0
Slammer 1800	01.04→	2	0 242 135 515	YR 7 DC+	1,0
Stalker 1800	01.04→	2	0 242 135 515	YR 7 DC+	1,0
Tejas 1800	01.04→	2	0 242 135 515	YR 7 DC+	1,0
Texas Chopper 1800	01.04→	2	0 242 135 515	YR 7 DC+	1,0
1850 cc					
Bandit 1850	01.99-12.03	2	0 242 229 687	WR 8 DCX+	1,0
Classic 1850	01.99-12.03	2	0 242 229 687	WR 8 DCX+	1,0
Legend 1850	01.99-12.03	2	0 242 229 687	WR 8 DCX+	1,0
Outlaw 1850	01.99-12.03	2	0 242 229 687	WR 8 DCX+	1,0
Slammer 1850	01.99-12.03	2	0 242 229 687	WR 8 DCX+	1,0
Stalker 1850	01.99-12.03	2	0 242 229 687	WR 8 DCX+	1,0
Thunder 1850	01.99-12.03	2	0 242 229 687	WR 8 DCX+	1,0
1900 cc					
Legend 1900	01.04→	2	0 242 135 515	YR 7 DC+	1,0
Outlaw 1900	01.04→	2	0 242 135 515	YR 7 DC+	1,0
Slammer 1900	01.04→	2	0 242 135 515	YR 7 DC+	1,0
Stalker 1900	01.04→	2	0 242 135 515	YR 7 DC+	1,0
Tejas 1900	01.04→	2	0 242 135 515	YR 7 DC+	1,0
Texas Chopper 1900	01.04→	2	0 242 135 515	YR 7 DC+	1,0
2000 cc					
Legend 2000	01.03→	2	0 242 135 515	YR 7 DC+	1,0
Outlaw 2000	01.03→	2	0 242 135 515	YR 7 DC+	1,0
Ranger 2000	01.03→	2	0 242 135 515	YR 7 DC+	1,0
Slammer 2000	01.03→	2	0 242 135 515	YR 7 DC+	1,0
Stalker 2000	01.03→	2	0 242 135 515	YR 7 DC+	1,0
Tejas 2000	01.03→	2	0 242 135 515	YR 7 DC+	1,0
Texas Chopper 2000	01.03→	2	0 242 135 515	YR 7 DC+	1,0

ANCILOTTI

125 cc					
PS 125 RX	01.84-12.93	1	0 241 274 505	W 07 CS	0,6
PST 125 MX	01.83-06.84	1	0 241 274 505	W 07 CS	0,6
PST 125 RG	01.84-12.94	1	0 241 274 505	W 07 CS	0,6

APRILIA

125 cc					
AF 1 /Futura/Sport/RR/Sintesi	06.88-12.94	1	0 241 274 505	W 07 CS	
AF 1 125 Replica	03.87-12.91	1	0 241 274 505	W 07 CS	
AFI 125 Replica	03.87-12.89	1	0 241 274 505	W 07 CS	0,6
AFI 125 Sintesi	06.88-12.89	1	0 241 274 505	W 07 CS	0,6
AS 125 R	01.91→	1	0 241 256 522	W 3 CC	0,5
Classic 125	01.97-12.98	1	0 242 274 501	WR 07 CS	0,6
	01.99-12.03	1	0 242 250 503	WR 4 CC	0,8
ETX 125	01.84-12.98	1	0 241 256 522	W 3 CC	0,5
	01.99-12.03	1	0 242 250 503	WR 4 CC	0,8
Europa 125	06.90-12.94	1	0 241 274 505	W 07 CS	
MX 125	01.83-12.88	1	0 241 256 515	W 3 CS	0,6
		1	0 242 255 502	WR 3 CC	0,7
	01.03-12.07	1	0 242 250 503	WR 4 CC	0,8
		1	0 242 274 501	WR 07 CS	0,6



Typ



Pegaso 125	01.91-12.95		1	0 241 274 505	W 07 CS	
Red Rose 125	01.88-12.96		1	0 241 274 505	W 07 CS	
	01.97→		1	0 242 250 503	WR 4 CC	0,8
RS 125	01.96-12.09		1	0 242 250 503	WR 4 CC	0,8
	01.99→		1	0 242 274 501	WR 07 CS	0,5
		LET,WW	1	0 242 250 503	WR 4 CC	
RS 125 Extrema Replica	01.92-12.12		1	0 242 274 501	WR 07 CS	0,5
RS4 125	01.10→		1	0 242 068 500	UR 08 CC	0,5
RX 125	01.90-12.98		1	0 241 274 505	W 07 CS	
	01.08→	LEN	1	0 242 274 501	WR 07 CS	0,7
		LET	1	0 242 250 503	WR 4 CC	0,7
Sportcity One 125	01.08→		1	0 242 060 501	UR 2 CC	0,6
ST 125	01.82→		1	0 241 256 515	W 3 CS	0,5
Strada 125	01.83-12.88		1	0 241 256 515	W 3 CS	0,6
			1	0 242 255 502	WR 3 CC	0,7
STX 125	01.82→		1	0 241 256 515	W 3 CS	0,5
SX 125	01.08→	LEN	1	0 242 274 501	WR 07 CS	0,7
		LET	1	0 242 250 503	WR 4 CC	0,7
Tuareg 125	01.86-12.94		1	0 241 256 522	W 3 CC	0,5
Tuareg 125 Rally	06.89-12.94		1	0 241 274 505	W 07 CS	
Tuareg 125 Wind	07.88-12.94		1	0 241 256 522	W 3 CC	0,6
Tuono 125	01.03→	LEN	1	0 242 274 501	WR 07 CS	0,7
		LET	1	0 242 250 503	WR 4 CC	0,7
TX 125	01.85-12.95		1	0 242 229 656	WR 8 DC+	0,7
250 cc						
MX 250	01.85-12.89			0 241 274 505	W 07 CS	0,6
RX 250	01.85-04.86		1	0 241 274 505	W 07 CS	
Tuareg 250 Rally	01.85-12.92		1	0 241 274 505	W 07 CS	
250 GP	01.80-12.99		2	0 241 274 505	W 07 CS	
280 cc						
Climber 280	01.89-12.91		1	0 241 229 715	W 8 DC	0,7
TX 300	01.80-12.90		1	0 241 229 715	W 8 DC	0,7
TX 311 M	01.80-12.90		1	0 241 229 715	W 8 DC	0,7
TXR 312 M	01.80-12.90		1	0 241 229 715	W 8 DC	0,5
320 cc						
TL 320	01.80-12.86		1	0 241 229 715	W 8 DC	0,5
Trial 320 SC	01.83-12.88		1	0 241 274 505	W 07 CS	
350 cc						
ETX 350	01.85-12.90		1	0 241 150 504	X 4 CC	0,5
Tuareg Wind 350	01.87-12.93		1	0 241 150 504	X 4 CC	0,5
Tuareg 350	01.87-12.91		1	0 241 150 504	X 4 CC	0,5
450 cc						
RXV 4.5	01.06-12.07		2	0 242 065 500	UR 09 CC	0,7
SXV 4.5	01.06-12.07		2	0 242 065 500	UR 09 CC	0,7
550 cc						
RXV 5.5	01.06-12.07		2	0 242 065 500	UR 09 CC	0,7
SXV 5.5	01.06-12.07		2	0 242 065 500	UR 09 CC	0,7
600 cc						
ETX 600 Tuareg	01.85-12.90		1	0 241 150 504	X 4 CC	
Pegaso 600	03.90-12.94		1	0 241 150 504	X 4 CC	0,6
Tuareg 600 Wind	01.87-12.93		1	0 241 150 504	X 4 CC	0,6
650 cc						
Moto 6.5	01.95-12.03		1	0 241 150 504	X 4 CC	0,6
Pegaso 650	04.92-12.00		1	0 242 150 507	XR 4 CC	0,7
	01.05-12.09		1	0 242 060 501	UR 2 CC	0,6



A



◀ APRILIA

1000 cc						
ETV 1000 Caponord	01.01-12.07	2	0 242 150 506	YR 4 DE	0,7	
RST 1000 Futura	01.01-12.06	2	0 242 150 506	YR 4 DE	0,7	
RSV Mille /R	09.98-12.03	2	0 242 150 506	YR 4 DE	0,7	
RSV Mille R	01.04-12.08	2	0 242 150 506	YR 4 DE	0,7	
RSV Mille R Factory	01.04-12.08	2	0 242 150 506	YR 4 DE	0,7	
RSV4 Factory	01.09→	4	0 242 068 500	UR 08 CC	0,7	
SL 1000 Falco	09.99-12.04	2	0 242 150 506	YR 4 DE	0,7	
Tuono 1000 /Fighter /R	01.03-12.09	2	0 242 150 506	YR 4 DE	0,7	
1000 V4 RSR	01.07→	4	0 242 150 506	YR 4 DE	0,7	

ASPES

125 cc					
SK 125	11.85-12.95		0 242 250 503	WR 4 CC	0,5
Yuma 125 Monoscoocca	01.81-12.84	1	0 242 250 503	WR 4 CC	0,5
Yuma 125 TSB	01.83-12.84	1	0 242 250 503	WR 4 CC	0,5

ATK

125 cc					
125 Enduro	01.03-12.09	1	0 241 150 504	X 4 CC	0,7
250 cc					
250 AC	01.88-12.96	1	0 241 248 538	W 4 CC	0,5
250 LC	01.95-12.03	1	0 241 248 538	W 4 CC	0,5
260 LC	01.95-12.02	1	0 241 248 538	W 4 CC	0,5
350 cc					
350 Cross	01.91-12.99	1	0 241 150 504	X 4 CC	0,5
350 Enduro	01.91-12.02	1	0 241 150 504	X 4 CC	0,7
400 cc					
406	01.88-12.99	1	0 241 248 538	W 4 CC	0,5
450 cc					
450	01.03→	1	0 241 248 538	W 4 CC	0,5
500 cc					
500 DT	01.99-12.03	1	0 241 150 504	X 4 CC	0,5
500 Enduro	01.98-12.03	1	0 241 150 504	X 4 CC	0,7
500 Supermotard	01.01→	1	0 241 150 504	X 4 CC	0,5
560 cc					
604 MX	01.88→	1	0 241 150 504	X 4 CC	0,7
600 cc					
600 DT	01.98→	1	0 241 150 504	X 4 CC	0,7
600 Supermotard	01.01-12.02	1	0 241 150 504	X 4 CC	0,5
	01.03-12.09	1	0 242 074 500	UR 07 CDC	0,8
605 Cross	01.93→	1	0 241 150 504	X 4 CC	0,5
605 Enduro	01.93→	1	0 241 150 504	X 4 CC	0,7

BENELLI

125 cc					
BX 125 E	10.86-06.89	1	0 242 255 502	WR 3 CC	0,6
Custom 125	01.86-06.89	2	0 241 248 538	W 4 CC	0,5
		2	0 241 256 515	W 3 CS	0,5



Enduro 125	02.76-09.86	1	0 241 245 581	W 5 CC	0,7
Jarno 125	01.88-12.93	1	0 241 248 538	W 4 CC	0,5
Turismo 125	02.76-09.86	1	0 241 248 538	W 4 CC	0,5
		1	0 241 256 515	W 3 CS	0,5
125 BX	10.86-06.89	1	0 242 255 502	WR 3 CC	0,5
125 SE	01.77-06.80	2	0 241 248 538	W 4 CC	0,5
		2	0 241 256 515	W 3 CS	0,5
125 2C Twin	01.76-12.82	2	0 241 245 581	W 5 CC	0,5
230 cc					
304	09.82-12.93	4	0 241 245 580	W 5 AC	0,6
250 cc					
250 Quattro	10.77-06.80	4	0 241 245 580	W 5 AC	0,6
254	01.80-07.82	4	0 241 245 580	W 5 AC	0,6
600 cc					
654	01.80-12.86	4	0 241 150 504	X 4 CC	0,5
900 cc					
Tornado Limited Edition	01.00-12.05	3	0 242 068 500	UR 08 CC	0,7
Tornado 900	01.00→	3	0 242 068 500	UR 08 CC	0,7
1130 cc					
TnT 1130	01.04-12.08	3	0 242 068 500	UR 08 CC	0,7
TnT 1130 Cafe Racer	01.06→	3	0 242 068 500	UR 08 CC	0,7
TnT 1130 Sport EVO	05.06→	3	0 242 068 500	UR 08 CC	0,7
Tornado Tre 1130	01.06→	3	0 242 068 500	UR 08 CC	0,7
Trek 1130	01.06→	3	0 242 068 500	UR 08 CC	0,7
Trek 1130 Amazonas	01.07→	3	0 242 068 500	UR 08 CC	0,7

BETA-INTERMOTOR

80 cc					
REV 80	01.03-12.08	1	0 241 256 522	W 3 CC	0,5
125 cc					
Alp 125	01.04-12.06	1	0 242 065 501	UR 09 AC	0,8
	01.07→	1	0 242 055 501	UR 3 AC	0,8
Alp 125 4T	01.99-12.03	1	0 242 150 507	XR 4 CC	0,6
REV 3 125	01.00-12.08	1	0 241 235 755	W 7 DC	0,6
		1	0 242 245 521	WR 5 CC	0,6
RR 125	01.06→	1	0 242 065 501	UR 09 AC	0,8
TR 32	10.84-12.94	1	0 241 229 579	W 8 CC	0,5
TR 34	01.87-12.89	1	0 241 248 538	W 4 CC	0,5
Zero 125	01.92-12.94	1	0 241 248 538	W 4 CC	0,5
125 Custom	07.81-12.82	1	0 241 248 538	W 4 CC	0,5
	01.83-12.91	1	0 241 235 089	W 7 CC	0,6
125 KR	06.85-12.95	1	0 241 248 538	W 4 CC	0,5
125 Rally	11.84-12.94	1	0 241 229 579	W 8 CC	0,5
125 RXA	10.83-11.84	1	0 241 248 538	W 4 CC	0,5
125 SC	11.79-04.84	1	0 241 274 505	W 07 CS	0,5
125 Scrambler	04.81-11.84	1	0 241 248 538	W 4 CC	0,5
125 Trial	01.81-01.83	1	0 241 229 579	W 8 CC	0,5
200 cc					
Alp 200 /4T	01.99→	1	0 242 150 507	XR 4 CC	0,7
REV 3 200	01.06→	1	0 241 235 755	W 7 DC	0,6
		1	0 242 245 521	WR 5 CC	0,6
240 cc					
Super Trail 250	01.92-12.94	1	0 241 248 538	W 4 CC	0,5



◀ BETA-INTERMOTOR

240 Custom	01.79-02.83		0 241 248 538	W 4 CC	0,5
240 Trial	07.81-10.83	1	0 241 229 579	W 8 CC	0,5
250 CR	10.79-02.83	1	0 241 274 505	W 07 CS	0,6
250 GS	10.79-02.83	1	0 241 274 505	W 07 CS	0,6
250 KR	06.85-12.95	1	0 241 248 538	W 4 CC	0,5
250 cc					
Alp 250	01.97-12.01	1	0 241 248 538	W 4 CC	0,5
REV 3 250	01.00-12.08	1	0 241 235 755	W 7 DC	0,6
RR 250	01.05-12.07	1	0 242 140 519	YR 6 DES	0,9
250 Afrika	01.86-12.96	1	0 241 248 538	W 4 CC	0,5
260 cc					
Alp 260	01.90-12.02	1	0 241 248 538	W 4 CC	0,5
Synt 260	01.92-12.96	1	0 241 248 538	W 4 CC	0,5
TR 34	01.87-12.89	1	0 241 248 538	W 4 CC	0,5
Zero 260	01.90-12.96	1	0 241 248 538	W 4 CC	0,5
275 cc					
REV 3 270	01.05-12.08	1	0 241 235 755	W 7 DC	0,6
		1	0 242 245 521	WR 5 CC	0,6
350 cc					
Alp 4.0	01.04→	1	0 242 074 500	UR 07 CDC	0,7
Euro 350	01.01→	1	0 242 074 500	UR 07 CDC	0,7
Jonathan 350	01.01→	1	0 242 074 500	UR 07 CDC	0,7
Motard 4.0	01.03→	1	0 242 074 500	UR 07 CDC	0,7
M4 350	01.04→	1	0 242 074 500	UR 07 CDC	0,8
350 GS	10.79-02.83	1	0 241 274 505	W 07 CS	0,6
400 cc					
RR 400	01.05→	1	0 242 140 519	YR 6 DES	0,9
450 cc					
RR 450	01.05→	1	0 242 140 519	YR 6 DES	0,9
500 cc					
RR 525	01.05→	1	0 242 140 519	YR 6 DES	0,9

BIG DOG

1340 cc					
Aeroglide 1340	01.97-12.97	2	0 242 229 687	WR 8 DCX+	1,1
Coyote 1340	01.96-12.96	2	0 242 229 687	WR 8 DCX+	1,1
Proglide 1340	01.95-12.97	2	0 242 229 687	WR 8 DCX+	1,1
Vintage 1340	01.95-12.97	2	0 242 229 687	WR 8 DCX+	1,1
1440 cc					
Aerosport 1440	01.98-12.98	2	0 242 229 687	WR 8 DCX+	1,1
Bulldog 1440	01.98-12.98	2	0 242 229 687	WR 8 DCX+	1,1
Pitbull 1440	01.98-12.99	2	0 242 229 687	WR 8 DCX+	1,1
Prosport 1440	01.98-12.98	2	0 242 229 687	WR 8 DCX+	1,1
Vintage 1440	01.98-12.98	2	0 242 229 687	WR 8 DCX+	1,1
1570 cc					
Vintage 1570	01.99-12.99	2	0 242 229 687	WR 8 DCX+	1,1
1900 cc					
Bulldog 1900	01.05-12.07	2	0 242 135 515	YR 7 DC+	0,8
Chopper 1900	01.05-12.07	2	0 242 135 515	YR 7 DC+	0,8
Coyote 1900	01.09→	2	0 242 135 515	YR 7 DC+	0,8
K-9 EFI 1900	01.08→	2	0 242 135 515	YR 7 DC+	0,8
K-9 1900	01.06→	2	0 242 135 515	YR 7 DC+	0,8
Mastiff EFI 1900	01.08→	2	0 242 135 515	YR 7 DC+	0,8



Typ



Mastiff 1900	01.05→	2	0 242 135 515	YR 7 DC+	0,8
Mutt 1900	01.08-12.08	2	0 242 135 515	YR 7 DC+	0,8
Pitbull EFI 1900	01.09→	2	0 242 135 515	YR 7 DC+	0,8
Pitbull 1900	01.05→	2	0 242 135 515	YR 7 DC+	0,8
Ridgeback 1900	01.05→	2	0 242 135 515	YR 7 DC+	0,8
Wolf 1900	01.09→	2	0 242 135 515	YR 7 DC+	0,8

BIMOTA

600 cc					
YB9 Bellaria 600	01.90-12.93	4	0 242 068 500	UR 08 CC	0,7
YB9 SR 600	01.95-12.98	4	0 242 068 500	UR 08 CC	0,7
650 cc					
BB1 650	01.95-12.97	1	0 241 150 504	X 4 CC	0,7
750 cc					
DB1 S 750	01.86-12.86	2	0 241 245 656	W 5 BC	0,5
SB7 750	01.94-12.95	4	0 242 074 500	UR 07 CDC	0,7
YB4 750	01.88-12.89	4	0 242 150 507	XR 4 CC	0,7
900 cc					
DB2 SR 900	01.94-12.96	2	0 242 145 516	XR 5 DC	0,9
DB2 900	01.93-12.95	2	0 242 145 516	XR 5 DC	0,9
DB3 Mantra 900	01.95-12.98	2	0 242 145 516	XR 5 DC	0,9
1000 cc					
DB 5 Mille 1000	01.05→	2	0 242 140 519	YR 6 DES	0,9
SB8 R 1000	01.98-12.00	2	0 242 074 500	UR 07 CDC	0,7
YB6 1000	01.88-12.90	4	0 242 150 507	XR 4 CC	0,7
YB8 1000	01.90-12.92	4	0 242 150 507	XR 4 CC	0,7
YB11 1000	01.96-12.01	4	0 242 150 507	XR 4 CC	0,7
1100 cc					
DB6 R 1100	01.07→	2	0 242 140 519	YR 6 DES	0,9
SB5 1100	01.85-12.86	4	0 242 150 505	XR 4 DC	0,9
SB6 R 1100	01.96-12.98	4	0 242 068 500	UR 08 CC	0,7
SB6 1100	01.94-12.96	4	0 242 068 500	UR 08 CC	0,7
1200 cc					
YB5 1200	01.87-12.88	4	0 242 145 516	XR 5 DC	0,9

BMW

475 cc					
R 45/N	06.78-07.85	2	0 241 235 755	W 7 DC	0,7
650 cc					
F 650	09.93-04.03	1	0 241 150 504	X 4 CC	0,7
F 650 GS	09.99-11.03	1	0 241 150 504	X 4 CC	0,6
	03.08-06.12	2	0 242 140 519	YR 6 DES	0,9
F 650 GS Dakar	09.99-11.03	1	0 241 150 504	X 4 CC	
F 650 ST	11.96-09.00	1	0 241 150 504	X 4 CC	0,6
750 cc					
R 75/7	09.76-08.79	2	0 241 235 755	W 7 DC	0,6
800 cc					
F 800 GS	03.08-07.12	2	0 242 140 519	YR 6 DES	0,9
F 800 R	04.09→	2	0 242 140 519	YR 6 DES	
F 800 S	05.06-05.10	2	0 242 140 519	YR 6 DES	0,9
F 800 ST	09.06-07.12	2	0 242 140 519	YR 6 DES	0,9



Typ



◀ BMW

R 80	01.84-12.95		2	0 241 235 755	W 7 DC	0,7
R 80 GS	09.80-12.95		2	0 241 235 755	W 7 DC	0,7
R 80 R	01.91-12.94		2	0 241 235 755	W 7 DC	0,7
R 80 RT	01.84-12.95		2	0 241 235 755	W 7 DC	0,7
R 80 ST	11.82-12.84		2	0 241 235 755	W 7 DC	0,7
R 80/7 N	09.77-08.80		2	0 241 235 755	W 7 DC	0,7
R 80/7 S	09.77-08.80		2	0 241 235 755	W 7 DC	0,7
980 cc						
R 100 GS Dakar	09.87-12.90		2	0 241 235 755	W 7 DC	0,7
R 100 R	01.91-12.95		2	0 241 235 755	W 7 DC	0,7
R 100 R Mystic	01.93-01.96		2	0 241 235 755	W 7 DC	0,7
R 100 RS	09.86-10.92		2	0 241 235 755	W 7 DC	0,7
R 100/7	09.76-08.84		2	0 241 235 755	W 7 DC	0,6
1200 cc						
K 1200 GT	09.02-07.05		4	0 242 135 515	YR 7 DC+	0,8
K 1200 LT	09.98-07.08		4	0 242 135 515	YR 7 DC+	0,8
K 1200 RS	10.96-07.05		4	0 242 135 515	YR 7 DC+	0,8

BOOM TRIKE

1600 cc

Classic Trike Chopper 1.6	01.05-12.08	ERL	4	0 241 245 580	W 5 AC	0,6
		LEN	4	0 241 235 607	W 7 AC	0,6
Classic Trike Family 1.6	01.05-12.08	ERL	4	0 241 245 580	W 5 AC	0,6
		LEN	4	0 241 235 607	W 7 AC	0,6
Classic Trike Low Rider 1.6	01.05-12.08	ERL	4	0 241 245 580	W 5 AC	0,6
		LEN	4	0 241 235 607	W 7 AC	0,6

BSA

125 cc

Tracker 125	01.75-12.90		1	0 241 248 538	W 4 CC	0,5
-------------	-------------	--	---	---------------	--------	-----

175 cc

Tracker 175	01.75-12.90		1	0 241 248 538	W 4 CC	0,5
-------------	-------------	--	---	---------------	--------	-----

BSM

100 cc

Thunderbike 2 100	01.99-12.09		1	0 242 240 561	WR 6 BC	0,6
-------------------	-------------	--	---	---------------	---------	-----

125 cc

Thunderbike 4 125	01.99-12.09		1	0 242 065 501	UR 09 AC	0,7
-------------------	-------------	--	---	---------------	----------	-----

BUELL

1000 cc

RR 1000 BattleTwin	01.86-12.88		2	0 242 135 515	YR 7 DC+	1,0
XB9R 1000 Firebolt	01.01-12.07		2	0 242 150 506	YR 4 DE	0,9
XB9S 1000 Lightning	01.03-12.07		2	0 242 150 506	YR 4 DE	0,9
XB9SX 1000 Lightning CityX	01.05→		2	0 242 150 506	YR 4 DE	0,9

1200 cc

M2 1200 Cyclone	01.97-12.03		2	0 242 140 519	YR 6 DES	1,0
-----------------	-------------	--	---	---------------	----------	-----



Typ



RSS 1200 /RS/RR	01.88-12.94	2	0 242 140 519	YR 6 DES	1,0
S1 1200 Lightning/White Lightning	01.96-12.99	2	0 242 140 519	YR 6 DES	1,0
S2 1200 Thunderbolt	01.94-12.97	2	0 242 140 519	YR 6 DES	1,0
S3 1200 Thunderbolt	01.97-12.02	2	0 242 140 519	YR 6 DES	1,0
XB12R 1200 Firebolt	01.04→	2	0 242 150 506	YR 4 DE	0,9
XB12S TT 1200 Lightning Super	01.07-12.08	2	0 242 150 506	YR 4 DE	0,9
XB12S 1200 Lightning	01.04→	2	0 242 150 506	YR 4 DE	0,9
XB12Scg 1200 Lightning Short	01.07→	2	0 242 150 506	YR 4 DE	0,9
XB12Ss 1200 Lightning Long	01.06→	2	0 242 150 506	YR 4 DE	0,9
XB12X 1200 Ulysses	01.05→	2	0 242 150 506	YR 4 DE	0,9
XB12XT 1200 Ulysses	01.09→	2	0 242 150 506	YR 4 DE	0,9
X1 1200 Lightning	01.99-12.02	2	0 242 140 519	YR 6 DES	1,0

BULTACO

75 cc						
Frontera 74	01.76-12.81	1	0 241 256 512	W 3 AC	0,5	
Sherpa T 74	01.76-12.82	1	0 241 235 607	W 7 AC	0,5	
Streaker 74	01.77-12.84	1	0 241 235 607	W 7 AC	0,5	
125 cc						
Sherco 125	01.99-12.01	1	0 242 229 656	WR 8 DC+	0,6	
Sherpa T 125	01.76-12.80	1	0 241 235 607	W 7 AC	0,5	
Streaker 125	01.77-12.79	1	0 241 235 607	W 7 AC	0,5	
175 cc						
Mercurio 175 GT	01.76-12.83	1	0 241 229 715	W 8 DC	0,5	
200 cc						
Sherco 200	01.99-12.01	1	0 242 229 656	WR 8 DC+	0,6	
250 cc						
Frontera 250	01.75-12.81	1	0 241 248 538	W 4 CC	0,5	
Metrala 250 GTS	01.82-12.92	1	0 241 229 715	W 8 DC	0,5	
Sherco 250	01.99-12.01	1	0 242 229 656	WR 8 DC+	0,6	
270 cc						
Sherco 290	01.99-12.01	1	0 242 229 656	WR 8 DC+	0,6	
350 cc						
Matador 350	01.75-12.79	1	0 241 229 715	W 8 DC	0,5	
360 cc						
Frontera 370	01.75-12.81	1	0 241 248 538	W 4 CC	0,5	
Pursang 370	01.76-12.79	DOV	1	0 241 248 538	W 4 CC	0,5
			1	0 241 256 515	W 3 CS	0,5
420 cc						
Pursang 420	01.79-12.80	1	0 241 248 538	W 4 CC	0,5	

CAGIVA

80 cc					
Cocis 75	01.89-12.92	1	0 241 248 538	W 4 CC	0,5
W 4	01.92-12.94	1	0 241 248 538	W 4 CC	0,5
		1	0 241 248 538	W 4 CC	0,5
125 cc					
Aletta Electra 125	01.84-12.88	1	0 241 256 522	W 3 CC	0,5
Aletta Low Rider 125	01.82-12.86	1	0 241 248 538	W 4 CC	0,5
Aletta Oro 125	01.85-12.85	1	0 241 256 515	W 3 CS	0,5
	01.86-12.87	1	0 241 256 522	W 3 CC	0,6



◀ CAGIVA

Aletta Rossa 125	01.83-12.87	1	0 241 256 515	W 3 CS	0,5
Blues 125	10.87-12.93	1	0 241 256 522	W 3 CC	0,5
Cruiser 125	01.87-12.89	1	0 241 256 522	W 3 CC	0,5
Elefant 125	01.84-12.85	1	0 241 256 515	W 3 CS	0,5
	01.86-12.91	1	0 241 256 522	W 3 CC	0,5
Freccia C9 125	01.87-12.90	1	0 241 256 522	W 3 CC	0,6
Freccia C10 125 /R	01.87-12.90	1	0 241 256 522	W 3 CC	0,6
Freccia C12 125 R /SP	06.87-12.91	1	0 241 256 522	W 3 CC	0,6
Mito 125	01.99-12.07	1	0 242 255 504	WR 3 CS	0,5
Mito 125 Evolution	01.95-12.98	1	0 242 274 501	WR 07 CS	0,6
Mito 125 SP525	01.08 →	1	0 242 255 504	WR 3 CS	0,5
N90 125	01.88-12.92	1	0 241 256 522	W 3 CC	0,5
Planet 125	01.98-12.04	1	0 242 255 504	WR 3 CS	0,5
Raptor 125	01.03 →	1	0 242 255 504	WR 3 CS	0,5
Roadster 125	01.94-12.00	1	0 242 255 502	WR 3 CC	0,6
RX 125 Rally	01.81-12.82	1	0 241 256 515	W 3 CS	0,5
SST 125	01.82-12.82	1	0 241 248 538	W 4 CC	0,5
SuperCity 125 Ev	01.97-12.01	1	0 242 255 504	WR 3 CS	0,5
SX 125	01.82-11.83	1	0 241 248 538	W 4 CC	0,5
SXT 125	01.75-12.84	1	0 241 256 522	W 3 CC	0,5
Tamanaco 125	01.88-12.93	1	0 241 256 522	W 3 CC	0,6
W 8 125	01.96-12.97	1	0 241 256 522	W 3 CC	0,5
	01.98-12.01	1	0 242 255 502	WR 3 CC	0,6
WR 125	01.02 →	1	0 242 255 504	WR 3 CS	0,5
WRE 125	01.02 →	1	0 242 255 504	WR 3 CS	0,5
WRX 125	01.82-12.83	1	0 241 256 515	W 3 CS	0,5
WSXT 125	01.82-12.88	1	0 241 256 515	W 3 CS	0,5
175 cc					
Blues 175	08.91-12.01		0 241 245 581	W 5 CC	0,5
SS 175	01.79-11.81		0 241 248 538	W 4 CC	0,5
SX 175	01.79-11.81		0 241 248 538	W 4 CC	0,5
200 cc					
Elefant 200	01.84-12.86	1	0 241 256 522	W 3 CC	0,5
Roadster 200	01.96-12.97	1	0 241 256 522	W 3 CC	0,5
WMX 190/200	01.82-12.84	1	0 241 256 522	W 3 CC	0,5
250 cc					
MXR 250	01.79-12.84	1	0 241 256 522	W 3 CC	0,5
RX 250 Rally	01.79-12.84	1	0 241 256 515	W 3 CS	0,5
SS 250/RL	01.83-12.93	1	0 241 248 538	W 4 CC	0,5
SST 250	01.83-12.85	1	0 241 248 538	W 4 CC	0,5
SX 250	01.82-12.84	1	0 241 248 538	W 4 CC	0,5
SXT 250	01.75-12.85	1	0 241 248 538	W 4 CC	0,5
WMX 250	01.88-12.91	1	0 241 256 522	W 3 CC	0,5
WRX 250	01.83-12.84	1	0 241 274 505	W 07 CS	0,6
350 cc					
Ala Azzurra 350, GT	01.84-12.94	1	0 242 245 531	WR 5 BC	0,6
Ala Blu 350	01.83-12.86	1	0 241 248 538	W 4 CC	0,5
Ala Rossa 350	01.83-12.88	1	0 241 248 538	W 4 CC	0,5
Ala Verde 350	01.86-12.87	1	0 241 248 538	W 4 CC	0,5
Alazzurra 350	01.84-12.88	2	0 241 245 656	W 5 BC	0,5
Cresta 350	01.82-12.92	1	0 242 229 656	WR 8 DC+	0,6
Elefant 350	01.85-12.89	1	0 241 245 656	W 5 BC	0,5
SST 350	01.78-12.86	1	0 241 248 538	W 4 CC	0,5
SX 350	01.79-12.83	1	0 241 248 538	W 4 CC	0,5
SXT 350	01.83-12.93	1	0 241 248 538	W 4 CC	0,5



TR 350	01.82-12.88	1	0 242 229 656	WR 8 DC+	0,6
Trial 350	01.82-12.88	1	0 241 229 715	W 8 DC	0,6
500 cc					
Canyon 500	01.97-12.02	1	0 242 135 515	YR 7 DC+	0,8
650 cc					
Alazzurra 650	01.84-12.88	2	0 241 245 656	W 5 BC	0,6
Elefant 650	01.85-12.89	2	0 241 245 656	W 5 BC	0,6
Raptor 650	01.01-12.04	2	0 242 065 500	UR 09 CC	0,7
V-Raptor 650	01.01-12.04	2	0 242 065 500	UR 09 CC	0,7
900 cc					
Elefant 900 AC	01.93-12.98	2	0 242 150 505	XR 4 DC	0,9
Elefant 900 ie	01.90-12.93	2	0 242 150 505	XR 4 DC	0,9
1000 cc					
Navigator 1000	01.00-12.05	2	0 242 060 505	UR 2 CDC	0,7
Raptor 1000	01.00-12.05	2	0 242 060 505	UR 2 CDC	0,7
V-Raptor 1000	01.00-12.05	2	0 242 060 505	UR 2 CDC	0,7
X-tra Raptor 1000	01.00-12.06	2	0 242 060 505	UR 2 CDC	0,7

CAN-AM

125 cc					
MX L C 125	01.83-12.86	1	0 241 256 522	W 3 CC	0,5
MX 6 125	06.80-12.82	1	0 241 248 538	W 4 CC	0,5
Qualifier IV 125	01.80-12.82	1	0 241 248 538	W 4 CC	0,5
175 cc					
Qualifier 175	01.77-12.81	1	0 241 256 522	W 3 CC	0,5
200 cc					
200 ASE	01.85-12.87	1	0 241 256 522	W 3 CC	0,5
250 cc					
Military 250	06.78-12.88	1	0 241 248 538	W 4 CC	0,4
MX 2 250	01.75-12.76	1	0 241 256 522	W 3 CC	0,5
MX 3 250	01.77-12.77	1	0 241 256 522	W 3 CC	0,5
MX 4 250	01.78-12.79	1	0 241 256 522	W 3 CC	0,5
MX 5 250	01.79-12.79	1	0 241 256 522	W 3 CC	0,5
MX 6 250	01.80-12.81	1	0 241 256 522	W 3 CC	0,5
MX 250 L C	09.83-12.87	1	0 241 256 522	W 3 CC	0,5
Qualifier 250	01.77-12.82	1	0 241 256 522	W 3 CC	0,5
240 Trials	01.85-12.86	1	0 241 256 522	W 3 CC	0,5
250 ASE	01.83-12.87	1	0 241 256 522	W 3 CC	0,5
275 cc					
Qualifier 280	06.80-12.83	1	0 241 256 522	W 3 CC	0,5
300 cc					
Trials 310	01.83-12.84	1	0 241 229 715	W 8 DC	0,5
350 cc					
Qualifier 350	06.80-12.83	1	0 241 256 522	W 3 CC	0,5
Trials 350	01.85-12.85	1	0 241 256 522	W 3 CC	0,5
370 cc					
MX 370	01.78-12.79	1	0 241 256 522	W 3 CC	0,5
Qualifier 370	01.79-12.79	1	0 241 256 522	W 3 CC	0,5
400 cc					
MX 400	01.80-12.81	1	0 241 256 522	W 3 CC	0,5
Qualifier 400	01.80-12.82	1	0 241 256 522	W 3 CC	0,5
500 cc					
MX 500	01.83-12.87	1	0 241 256 522	W 3 CC	0,5



◀ CAN-AM

Sonic 500	01.82-12.86	1	0 241 150 504	X 4 CC	0,5
500 ASE	01.83-12.87	1	0 241 256 522	W 3 CC	0,5
560 cc					
Sonic 560	01.84-12.86	1	0 241 150 504	X 4 CC	0,5

CANNONDALE

440 cc					
EX 400	01.01-12.03	1	0 242 074 500	UR 07 CDC	0,7
MX 400	01.00-12.03	1	0 242 074 500	UR 07 CDC	0,7
XC 400	01.01-12.03	1	0 242 074 500	UR 07 CDC	0,7

CARABELA

60 cc					
Ciclo Motor Ciao 60	01.80→	1	0 241 235 607	W 7 AC	0,5
Merida 60	01.83→	1	0 241 235 607	W 7 AC	0,5
100 cc					
Mini Marquesa 100 Enduro	01.77-12.87	1	0 241 235 089	W 7 CC	0,5
Mini moto 100	01.75-12.87	1	0 241 235 089	W 7 CC	0,5
Motorcarro 100	01.79-12.87	1	0 241 235 089	W 7 CC	0,5
Panthera 100 Enduro	01.77-12.87	1	0 241 235 607	W 7 AC	0,5
Torero 100 Flat Track	01.77-12.87	1	0 241 248 538	W 4 CC	0,6
125 cc					
De Luxe 125	01.77-12.82	1	0 241 235 089	W 7 CC	0,5
Torero Flat Track 125	01.77-12.82	1	0 241 248 538	W 4 CC	0,6
175 cc					
Marquesa 175 Enduro	01.75-12.77	1	0 241 248 538	W 4 CC	0,6
Marquesa 175 MK-II	01.75-12.77	1	0 241 248 538	W 4 CC	0,6
Rally 175 Enduro	01.75-12.77	1	0 241 235 089	W 7 CC	0,5
Strada 175	01.75-12.77	1	0 241 235 089	W 7 CC	0,5
Torero 175 Flat Track	01.77-12.78	1	0 241 248 538	W 4 CC	0,6
250 cc					
Centauro 250 Enduro	01.76-12.77	1	0 241 248 538	W 4 CC	0,6
Centauro 250 MX	01.76-12.77	1	0 241 248 538	W 4 CC	0,6
Torero 250 Flat Track	01.77-12.87	1	0 241 248 538	W 4 CC	0,6
360 cc					
Centauro 360 MX	01.78-12.82	1	0 241 248 538	W 4 CC	0,6
400 cc					
Enduro 400	01.76-12.86	1	0 241 235 089	W 7 CC	0,5
MX 400	01.76-12.86	1	0 241 248 538	W 4 CC	0,6
450 cc					
Centauro 450 MX II	01.77-12.78	1	0 241 248 538	W 4 CC	0,6
Enduro 450	01.77→	1	0 241 235 089	W 7 CC	0,5

CARREFOUR

125 cc					
PFM 125	01.00→	1	0 242 150 507	XR 4 CC	0,7



Typ



CCM

125 cc						
CMX 125	01.83-12.85	1	0 241 256 515	W 3 CS	0,5	
Moto X 125 Hiro	01.79-12.80	1	0 241 274 505	W 07 CS	0,5	
240 cc						
CMT Trails 240	01.82-12.82	1	0 241 229 715	W 8 DC	0,7	
250 cc						
CMT Trails 250	01.82-12.82	1	0 241 229 715	W 8 DC	0,7	
CMX 250	01.82-12.82	1	0 241 248 538	W 4 CC	0,5	
	01.83-12.85	1	0 241 256 515	W 3 CS	0,5	
Moto 250 Hiro	01.79-12.81	1	0 241 256 515	W 3 CS	0,5	
310 cc						
CMT Trails 310	01.82-12.82	1	0 241 229 715	W 8 DC	0,7	
320 cc						
CMT Trails 320	01.81-12.87	1	0 241 229 715	W 8 DC	0,7	
350 cc						
CMT Trails 350	01.81-12.87	1	0 241 229 715	W 8 DC	0,7	
Trails 350	01.78-12.80	1	0 241 235 089	W 7 CC	0,7	
500 cc						
CMX 500	01.82-12.82	1	0 242 150 507	XR 4 CC	0,7	
560 cc						
CCM 560 4T	01.89-12.91	1	0 242 150 507	XR 4 CC	0,7	
600 cc						
604 Roadster RS	01.01-12.01	1	0 242 150 507	XR 4 CC	0,7	
604 R/RS/R30	01.99-12.02	1	0 242 150 507	XR 4 CC	0,7	
604 Supermoto Dual Sport	01.01-12.01	1	0 242 150 507	XR 4 CC	0,7	
604 Trial Dual Sport	01.01-12.01	1	0 242 150 507	XR 4 CC	0,7	
650 cc						
R 30 SuperMoto	01.02-12.08	1	0 242 074 500	UR 07 CDC	0,7	
640 RS	01.99-12.02	1	0 242 150 507	XR 4 CC	0,7	
644 Dual Sport	01.01-12.08	1	0 242 080 500	UR 06 CDC	0,7	

CLIPIC

80 cc						
Trial R 80	01.00-12.05	1	0 241 256 522	W 3 CC	0,5	

CZ (MOTOKOV)

125 cc						
CZ 125	01.82-12.94	1	0 242 245 517	WR 5 AC	0,5	
CZ 488	01.94-12.01	1	0 241 235 607	W 7 AC	0,6	
175 cc						
CZ 175	01.82-12.91	1	0 242 235 533	WR 7 AC	0,5	
CZ 487	01.93-12.97	1	0 241 235 607	W 7 AC	0,6	
Enduro 175	01.77-12.87	1	0 242 235 533	WR 7 AC	0,5	
Trial 175	01.77-12.87	1	0 242 235 533	WR 7 AC	0,5	
250 cc						
CZ 485	01.81-12.90	1	0 241 235 607	W 7 AC	0,6	
Enduro 250	01.76-12.87	1	0 241 256 512	W 3 AC	0,5	



Typ



◀ CZ

350 cc

CZ 472	01.85-12.90	2	0 241 235 607	W 7 AC	0,6
--------	-------------	---	---------------	--------	-----

DAELIM

100 cc

Altino 100	01.98→	1	0 242 055 508	UHR 3 CC	0,9
------------	--------	---	---------------	----------	-----

125 cc

Roadwin 125	01.04→	1	0 242 068 501	UHR 08 CC	0,9
-------------	--------	---	---------------	-----------	-----

	03.09→	1	0 242 055 508	UHR 3 CC	0,9
--	--------	---	---------------	----------	-----

VC 125 Advance	01.97-12.01	1	0 242 055 508	UHR 3 CC	0,9
----------------	-------------	---	---------------	----------	-----

VL 125 Classic	01.00→	1	0 242 055 508	UHR 3 CC	0,9
----------------	--------	---	---------------	----------	-----

VL 125 Daystar	01.00-12.01	1	0 242 055 508	UHR 3 CC	0,9
----------------	-------------	---	---------------	----------	-----

VS 125 Advance	01.97→	1	0 242 055 508	UHR 3 CC	0,9
----------------	--------	---	---------------	----------	-----

VS 125 Evolution	01.97-12.01	1	0 242 055 508	UHR 3 CC	0,9
------------------	-------------	---	---------------	----------	-----

VT 125 Evolution	01.01→	1	0 242 055 508	UHR 3 CC	0,9
------------------	--------	---	---------------	----------	-----

DERBI

75 cc

Bi 3	01.91-12.95	1	0 241 248 538	W 4 CC	0,6
------	-------------	---	---------------	--------	-----

Coppa 75	01.85-12.85	1	0 241 248 538	W 4 CC	0,5
----------	-------------	---	---------------	--------	-----

Europa 75 RD	01.82-12.83	1	0 241 248 538	W 4 CC	0,5
--------------	-------------	---	---------------	--------	-----

Scoot 75	01.82-12.83	1	0 241 248 538	W 4 CC	0,5
----------	-------------	---	---------------	--------	-----

125 cc

GPR 125 Nude/Racing	01.04→	1	0 242 250 503	WR 4 CC	0,8
---------------------	--------	---	---------------	---------	-----

Mulhacen 125	01.06→	1	0 242 065 500	UR 09 CC	0,6
--------------	--------	---	---------------	----------	-----

Terra 125	01.02→	1	0 242 065 500	UR 09 CC	0,6
-----------	--------	---	---------------	----------	-----

650 cc

Mulhacen 659	01.06→	1	0 242 060 501	UR 2 CC	0,6
--------------	--------	---	---------------	---------	-----

DNEPR

650 cc

MT 11 650	01.81-12.92	2	0 241 235 754	W 7 BC	0,6
-----------	-------------	---	---------------	--------	-----

MT 16 650	01.81-12.92	2	0 241 235 754	W 7 BC	0,6
-----------	-------------	---	---------------	--------	-----

DUCATI

250 cc

F3 350	01.86-12.89	2	0 241 235 607	W 7 AC	0,5
--------	-------------	---	---------------	--------	-----

350 cc

GTL 350	01.75-12.84	2	0 241 235 607	W 7 AC	0,5
---------	-------------	---	---------------	--------	-----

GTV 350	01.79-12.82	2	0 242 245 517	WR 5 AC	0,5
---------	-------------	---	---------------	---------	-----

Indiana 350	01.86-06.90	2	0 242 245 517	WR 5 AC	0,5
-------------	-------------	---	---------------	---------	-----

Pantah 350 XL	01.82-12.84	2	0 242 240 561	WR 6 BC	0,6
---------------	-------------	---	---------------	---------	-----

S Desmo	01.79-01.80	2	0 242 245 517	WR 5 AC	0,5
---------	-------------	---	---------------	---------	-----

S 350	01.92-12.93	2	0 242 245 531	WR 5 BC	0,6
-------	-------------	---	---------------	---------	-----

Sport 350	01.91-12.92	2	0 241 229 715	W 8 BC	0,7
-----------	-------------	---	---------------	--------	-----

Sport 350 Desmo	01.77-12.81	2	0 242 245 517	WR 5 AC	0,5
-----------------	-------------	---	---------------	---------	-----

SS 350 Junior	01.91-12.94	1	0 241 245 656	W 5 BC	0,6
---------------	-------------	---	---------------	--------	-----



Vento 350	01.80-12.82	1	0 241 235 607	W 7 AC	0,5
350 SL	06.82-12.84	2	0 242 245 531	WR 5 BC	0,6
350 TL	07.83-12.84	2	0 242 245 531	WR 5 BC	0,6
400 cc					
Monster 400	01.01-12.02	2	0 242 140 519	YR 6 DES	0,9
SS 400 Junior	01.91-12.95	2	0 242 240 561	WR 6 BC	0,6
400 Supersport	03.92-12.94	2	0 242 245 531	WR 5 BC	0,6
500 cc					
Desmo 500 Sport	01.79-12.83	2	0 241 235 607	W 7 AC	0,5
Pantah 500	01.78-12.80	2	0 241 245 580	W 5 AC	0,5
Pantah 500 SL	01.81-12.83	2	0 242 240 561	WR 6 BC	0,6
500 Sport Twin	01.78-12.78	2	0 241 245 580	W 5 AC	0,5
600 cc					
Monster 600	08.93-12.01	2	0 242 140 519	YR 6 DES	0,9
Pantah 600 SL	05.81-12.84	2	0 242 240 561	WR 6 BC	0,6
Pantah 600 TL	01.82-12.83	2	0 242 240 561	WR 6 BC	0,6
SS 600	01.94-12.98	2	0 242 140 519	YR 6 DES	0,9
600 Supersport Carenata	08.93-12.99	2	0 242 150 505	XR 4 DC	0,9
600 Supersport Nuda	08.93-12.99	2	0 242 150 505	XR 4 DC	0,9
620 cc					
Multistrada 620	01.05-12.06	2	0 242 140 519	YR 6 DES	0,9
Supersport 620 S	01.03-12.04	2	0 242 140 519	YR 6 DES	0,9
650 cc					
Indiana 650	06.86-12.92	2	0 241 245 656	W 5 BC	0,6
Pantah 650 Replica	01.87-12.93	2	0 242 245 531	WR 5 BC	0,6
Pantah 650 SL	07.83-12.83	2	0 242 245 531	WR 5 BC	0,6
700 cc					
Monster 695	01.07-12.08	2	0 242 140 519	YR 6 DES	0,9
Monster 696	01.08→	2	0 242 140 519	YR 6 DES	0,9
750 cc					
Indiana 750	01.87-12.90	2	0 242 240 561	WR 6 BC	0,6
Monster 750	01.95-12.01	2	0 242 140 519	YR 6 DES	0,6
750 F1 /Desmo /LS	01.85-12.88	2	0 242 140 519	YR 6 DES	0,6
750 Montjuich	03.86-12.87	2	0 241 245 656	W 5 BC	0,6
750 Paso	01.86-12.92	2	0 242 140 519	YR 6 DES	0,6
750 Sport	01.88-12.92	2	0 242 240 561	WR 6 BC	0,6
800 cc					
Monster S2R 800	01.05-12.07	2	0 242 140 519	YR 6 DES	0,9
Monster 800 S /Dark	01.03-12.04	2	0 242 140 519	YR 6 DES	0,9
Supersport 800	01.03-12.04	2	0 242 140 519	YR 6 DES	0,9
800 Sport	01.03-12.03	2	0 242 140 519	YR 6 DES	0,9
900 cc					
Monster 900	01.93-12.98	2	0 242 140 519	YR 6 DES	0,9
Monster 900 i.e.	01.99-12.02	2	0 242 140 519	YR 6 DES	0,9
900 S	01.80-12.87	2	0 241 245 656	W 5 BC	0,6
900 SD Darmah	01.77-12.83	2	0 241 235 607	W 7 AC	0,6
900 SS	01.75-12.84	2	0 241 245 656	W 5 BC	0,6
900 SS Hailwood Replica	01.80-12.85	2	0 241 245 656	W 5 BC	0,6
900 SS i.e.	01.91-12.98	2	0 242 140 519	YR 6 DES	0,9
900 SS Supersport	01.88-12.90	2	0 242 140 519	YR 6 DES	0,9
900 SuperLight	01.91-12.98	2	0 242 140 519	YR 6 DES	0,9
900 Supersport	01.90-12.98	2	0 242 140 519	YR 6 DES	0,9
900 S2	01.82-06.84	2	0 241 245 656	W 5 BC	0,6
906 Paso	01.89-12.93	2	0 242 140 519	YR 6 DES	0,9
907 i.e.	01.90-12.94	2	0 242 140 519	YR 6 DES	0,9





◀ DUCATI

950 cc						
Sporttouring 944 ST2	01.97-12.03	2	0 242 140 519	YR 6 DES		0,9
1000 cc						
GT 1000	01.07-12.10	2	0 242 140 519	YR 6 DES		0,9
Monster S2R 1000	01.06-12.08	2	0 242 140 519	YR 6 DES		0,9
Monster 1000/S	01.03-12.05	2	0 242 140 519	YR 6 DES		0,9
Multistrada 1000 DS/S	01.03-12.06	2	0 242 140 519	YR 6 DES		0,9
Paul Smart 1000	01.06-12.06	2	0 242 140 519	YR 6 DES		0,9
Sport 1000	01.06-12.08	2	0 242 140 519	YR 6 DES		0,9
Supersport 1000	01.03-12.04	2	0 242 140 519	YR 6 DES		0,9
996	01.99-12.01	2	0 242 060 501	UR 2 CC		0,7
1000 S2	01.84-12.86	2	0 242 240 561	WR 6 BC		0,6
1100 cc						
Hypermotard 1100/S/SP	01.07-12.09	2	0 242 140 519	YR 6 DES		0,9
Multistrada 1100/S	01.07-12.09	2	0 242 140 519	YR 6 DES		0,9

DUNSTALL

750 cc						
Suzuki 750 GS	01.77-12.79	3	0 242 250 503	WR 4 CC		0,7

EPELLA

125 cc						
Chopper 2Z	01.07→	2	0 242 065 501	UR 09 AC		0,6

FANTIC

75 cc						
Caballero 75	01.80-12.84	1	0 241 260 507	W 2 AC		0,5
Caballero 80 RC	01.93-12.99	1	0 241 274 505	W 07 CS		0,6
Koala 80	01.93-12.96	1	0 241 248 538	W 4 CC		0,5
Oasis 75	01.90-12.93	1	0 241 248 538	W 4 CC		0,5
Trial K R00 80	02.92-12.02	1	0 241 256 522	W 3 CC		0,5
Trial 75	05.81→	1	0 241 256 512	W 3 AC		0,5
Trial 78.9	06.91-12.01	1	0 241 256 522	W 3 CC		0,5
80.9	02.92-12.02	1	0 241 260 507	W 2 AC		0,5
380 Caballero 80	02.81-01.83	1	0 241 260 507	W 2 AC		0,5
80 cc						
Caballero 80 Reg.	01.81-12.84	1	0 241 256 515	W 3 CS		0,5
Enduro 80	01.80→	1	0 241 256 515	W 3 CS		0,5
RSX 80	01.82-12.84	1	0 241 256 515	W 3 CS		0,5
125 cc						
Caballero 125	07.95→	1	0 241 256 515	W 3 CS		0,5
Caballero 125 Reg. Competizione	07.81-08.84	1	0 241 274 505	W 07 CS		0,6
Cross 125	01.78→	1	0 241 256 515	W 3 CS		0,5
Professional 125	01.83→	1	0 241 235 607	W 7 AC		0,5
Raider 125 LC	10.84-12.85	1	0 241 256 515	W 3 CS		0,6
		1	0 242 255 502	WR 3 CC		0,6
		1	0 242 255 504	WR 3 CS		0,6
RSX 125	01.82-07.83	1	0 241 256 515	W 3 CS		0,5



Sport HP 1	01.87-12.88	1	0 241 256 515	W 3 CS	0,6
		1	0 242 255 502	WR 3 CC	0,6
		1	0 242 255 504	WR 3 CS	0,6
Strada 125 HP 1	07.85-12.95	1	0 241 256 515	W 3 CS	0,6
		1	0 242 255 502	WR 3 CC	0,6
		1	0 242 255 504	WR 3 CS	0,6
Strada 125 LC	01.85-12.95	1	0 241 256 515	W 3 CS	0,6
		1	0 242 255 502	WR 3 CC	0,5
		1	0 242 255 504	WR 3 CS	0,5
Strada 125 Sport	11.83-06.85	1	0 241 256 515	W 3 CS	0,6
		1	0 242 255 502	WR 3 CC	0,5
		1	0 242 255 504	WR 3 CS	0,5
Trial K R00 125	02.92-12.02	1	0 241 256 515	W 3 CS	0,6
		1	0 242 255 502	WR 3 CC	0,5
		1	0 242 255 504	WR 3 CS	0,5
Trial 125	01.82-12.92	1	0 241 235 607	W 7 AC	0,5
Trial 125 Competition	01.79→	1	0 241 245 580	W 5 AC	0,5
Trial 125 Professional	10.83-12.85	1	0 242 245 517	WR 5 AC	0,5
	04.87-06.87	1	0 242 235 533	WR 7 AC	0,6
Trial 125 Progress 2	04.86-06.87	1	0 242 235 533	WR 7 AC	0,6
Trial 125.1	01.86-12.96	1	0 242 235 533	WR 7 AC	0,6
TX 250 Trial 125	01.78-12.84	1	0 241 256 515	W 3 CS	0,5
250 Trial	01.80-12.84	1	0 242 235 533	WR 7 AC	0,5
250 Trial 125	02.77-12.84	1	0 242 235 533	WR 7 AC	0,6
250 Trial 125.5	01.89-12.99	1	0 242 235 533	WR 7 AC	0,6
160 cc					
FM 350 Trial 200	03.81-12.84	1	0 242 245 531	WR 5 BC	0,6
Trial 201	01.85-02.87	1	0 241 245 656	W 5 BC	0,5
TX 160	01.75→	1	0 241 256 515	W 3 CS	0,5
350 Trial 200	01.80-12.84	1	0 242 245 531	WR 5 BC	0,6
175 cc					
Enduro 175	01.79→	1	0 241 256 515	W 3 CS	0,5
200 cc					
Trial 201	01.86-12.96	1	0 241 235 607	W 7 AC	0,5
210 cc					
Seven Days 241	09.86-12.87	1	0 242 245 517	WR 5 AC	0,6
Trial 240	01.82-12.84	1	0 242 245 517	WR 5 AC	0,6
Trial 241	09.86-12.96	1	0 242 245 517	WR 5 AC	0,6
Trial 243 Professional	04.87-06.87	1	0 242 245 517	WR 5 AC	0,6
250 cc					
Coach Weekend	01.91-12.01	1	0 242 255 502	WR 3 CC	0,7
		1	0 242 255 504	WR 3 CS	0,7
Raider 250 LC	08.84-12.86	1	0 242 255 502	WR 3 CC	0,6
		1	0 242 255 504	WR 3 CS	0,6
Trial Coach	06.89→	1	0 241 248 538	W 4 CC	0,5
Trial K R00 249	06.90-12.01	1	0 241 248 538	W 4 CC	0,5
Trial 240	01.81→	1	0 241 235 607	W 7 AC	0,5
Trial 300	12.83-04.86	1	0 242 250 503	WR 4 CC	0,6
Trial 301	07.85-12.95	1	0 241 248 538	W 4 CC	0,5
Trial 303 Professional	04.87-06.87	1	0 241 256 515	W 3 CS	0,5
Trial 305	06.89→	1	0 241 248 538	W 4 CC	0,5
Trial 307	06.90-12.01	1	0 241 248 538	W 4 CC	0,5





Typ

**GABBIANO****125 cc**

125 Reg. CRS Spec.	05.81-01.83	1	0 242 235 533	WR 7 AC	0,5
--------------------	-------------	---	---------------	---------	-----

GARELLI (AGRATI-GARELLI)**75 cc**

Sahel 80	01.88-12.91	1	0 241 256 522	W 3 CC	0,5
----------	-------------	---	---------------	--------	-----

125 cc

Tiger 125 XR	01.84-12.88	1	0 242 255 502	WR 3 CC	0,6
--------------	-------------	---	---------------	---------	-----

		1	0 242 255 504	WR 3 CS	0,6
--	--	---	---------------	---------	-----

Tiger 125 XRD	01.84-12.88	1	0 242 255 502	WR 3 CC	0,6
---------------	-------------	---	---------------	---------	-----

		1	0 242 255 504	WR 3 CS	0,6
--	--	---	---------------	---------	-----

XR 125	06.84-12.88	1	0 242 255 502	WR 3 CC	0,6
--------	-------------	---	---------------	---------	-----

		1	0 242 255 504	WR 3 CS	0,6
--	--	---	---------------	---------	-----

320 cc

Trial 323	01.85-12.87	1	0 241 229 715	W 8 DC	0,5
-----------	-------------	---	---------------	--------	-----

GAS-GAS**125 cc**

Contact T 12	01.94-12.98	1	0 241 229 715	W 8 DC	0,5
--------------	-------------	---	---------------	--------	-----

Enduro 125	01.97-12.04	1	0 242 255 504	WR 3 CS	0,6
------------	-------------	---	---------------	---------	-----

Pampera 125	01.04-12.05	1	0 242 235 663	WR 7 DC+	0,8
-------------	-------------	---	---------------	----------	-----

TT 125	01.97-12.01	1	0 241 256 515	W 3 CS	0,6
--------	-------------	---	---------------	--------	-----

	01.02→	1	0 242 255 504	WR 3 CS	0,6
--	--------	---	---------------	---------	-----

TXT 125	01.99→	1	0 242 229 656	WR 8 DC+	0,6
---------	--------	---	---------------	----------	-----

140 cc

Contact T 16	01.94→	1	0 241 229 715	W 8 DC	0,5
--------------	--------	---	---------------	--------	-----

160 cc

Pampera 160	01.97→	1	0 242 235 663	WR 7 DC+	0,8
-------------	--------	---	---------------	----------	-----

175 cc

TXT 200	01.99→	1	0 242 229 656	WR 8 DC+	0,6
---------	--------	---	---------------	----------	-----

200 cc

TT 200 Enduro	01.02→	1	0 242 255 504	WR 3 CS	0,6
---------------	--------	---	---------------	---------	-----

250 cc

Contact JT 25	01.94-12.94	1	0 241 229 715	W 8 DC	0,5
---------------	-------------	---	---------------	--------	-----

Cross TT 250	01.97-12.01	1	0 241 256 515	W 3 CS	0,5
--------------	-------------	---	---------------	--------	-----

	01.02→	1	0 242 255 504	WR 3 CS	0,6
--	--------	---	---------------	---------	-----

GT 25	01.91-12.94	1	0 241 229 715	W 8 DC	0,5
-------	-------------	---	---------------	--------	-----

JT 25	01.95-12.97	1	0 242 229 656	WR 8 DC+	0,6
-------	-------------	---	---------------	----------	-----

Pampera 250	01.04-12.05	1	0 242 235 663	WR 7 DC+	0,8
-------------	-------------	---	---------------	----------	-----

TXT 250	01.99→	1	0 242 229 656	WR 8 DC+	0,6
---------	--------	---	---------------	----------	-----

300 cc

Cross 300	01.02→	1	0 242 255 504	WR 3 CS	0,6
-----------	--------	---	---------------	---------	-----

TXT 280	01.98-12.99	1	0 241 229 715	W 8 DC	0,5
---------	-------------	---	---------------	--------	-----

	01.00-12.05	1	0 242 229 656	WR 8 DC+	0,6
--	-------------	---	---------------	----------	-----

350 cc

GT 32	01.91-12.93	1	0 241 229 715	W 8 DC	0,5
-------	-------------	---	---------------	--------	-----

Pampera 320	01.98→	1	0 242 235 663	WR 7 DC+	0,8
-------------	--------	---	---------------	----------	-----

Trial Halley 325	01.86-12.87	1	0 241 256 522	W 3 CC	0,5
------------------	-------------	---	---------------	--------	-----



Typ



Trial 327	01.87-12.90	1	0 241 229 715	W 8 DC	0,5
TXT 321	01.99-12.03	1	0 242 229 656	WR 8 DC+	0,6
400 cc					
EC 400 FSE	01.02→	1	0 242 065 500	UR 09 CC	0,7
450 cc					
450 FSE	01.02→	1	0 242 065 500	UR 09 CC	0,7

GILERA (PIAGGIO)

80 cc					
80 TG 2 3	03.82-12.82	1	0 241 256 522	W 3 CC	0,5
80 TT	05.81-12.82	1	0 241 248 538	W 4 CC	0,5
125 cc					
Arizona 125	01.84-12.88	1	0 241 256 515	W 3 CS	0,5
Crono 125	01.91-12.93	1	0 241 274 505	W 07 CS	0,6
CX 125	03.91-12.93	1	0 241 274 505	W 07 CS	0,6
DNA 125	01.00-12.00	1	0 242 065 500	UR 09 CC	0,7
	01.01-12.04	1	0 242 068 500	UR 08 CC	0,6
ER 125	12.87-03.88	1	0 241 256 522	W 3 CC	0,5
Fast Bike 125	02.87-12.89	1	0 241 256 522	W 3 CC	0,5
Freestyle 125	05.91-12.93	1	0 241 274 505	W 07 CS	0,6
Hawk 125	11.85-12.86	1	0 241 256 522	W 3 CC	0,5
KK 125	09.86-12.89	1	0 241 256 522	W 3 CC	0,5
KZ 125	03.86-12.89	1	0 241 256 522	W 3 CC	0,5
Nexus 125	01.07→	1	0 242 065 500	UR 09 CC	0,6
RC 125 Rally	04.87-12.88	1	0 241 256 522	W 3 CC	0,5
RTX 125	02.86-12.86	1	0 241 256 515	W 3 CS	0,5
RV 125	05.84-12.86	1	0 241 256 515	W 3 CS	0,5
RX 125	01.84-06.85	1	0 241 256 515	W 3 CS	0,5
R1 125/S	12.87-12.89	1	0 241 256 515	W 3 CS	0,5
SP 01	03.89-12.89	1	0 241 274 505	W 07 CS	0,6
SP 02 125	01.90-12.90	1	0 241 274 505	W 07 CS	0,6
Top Rally 125 RC	01.88-12.90	1	0 241 274 505	W 07 CS	0,5
XR1 125	03.88-12.89	1	0 241 256 515	W 3 CS	0,5
XR2 125	01.89-12.95	1	0 241 256 515	W 3 CS	0,5
125 GR1	01.76-03.81	1	0 241 245 581	W 5 CC	0,5
125 TG1	01.76-12.81	1	0 241 245 581	W 5 CC	0,5
125 TG2	12.81-12.83	1	0 241 248 538	W 4 CC	0,5
125 TG3	12.81-12.83	1	0 241 248 538	W 4 CC	0,5
180 cc					
DNA 180	01.00-12.00	1	0 242 065 500	UR 09 CC	0,7
	01.01-12.04	1	0 242 068 500	UR 08 CC	0,6
200 cc					
Arizona 200	11.85-12.88	1	0 241 256 515	W 3 CS	0,5
ER 200	01.87-03.88	1	0 241 274 505	W 07 CS	0,6
RV 200	01.85-12.86	1	0 241 256 515	W 3 CS	0,5
RX 200	01.85-12.88	1	0 241 256 515	W 3 CS	0,5
200 Custom	03.82-06.84	1	0 241 248 538	W 4 CC	0,5
200 RTX	02.86-12.86	1	0 241 256 515	W 3 CS	0,5
200 T4	01.79-12.85	1	0 241 248 538	W 4 CC	0,5
250 cc					
Arizona 250	11.85-12.86	1	0 241 256 522	W 3 CC	0,5
NGR 250	05.85-12.89	1	0 241 256 522	W 3 CC	0,5



◀ GILERA

600 cc						
Nordcape 600 FB	01.92-12.93	1	0 241 150 504	X 4 CC		0,5
Nordwest 600	01.91-12.94	1	0 242 150 506	YR 4 DE		0,7
RC 600	01.89-12.90	1	0 241 150 504	X 4 CC		0,5
RC 600 C	01.91-12.93	1	0 241 150 504	X 4 CC		0,5
600 SuperSport	01.02-12.03	4	0 242 068 500	UR 08 CC		0,7

HARLEY-DAVIDSON

125 cc						
SS 125	01.75-12.77	1	0 241 256 522	W 3 CC		0,5
SXT 125	01.75-12.77	1	0 241 256 522	W 3 CC		0,5
175 cc						
SS 175	01.75-12.77	1	0 241 256 522	W 3 CC		0,5
250 cc						
SST 250	01.75-12.78	1	0 241 248 538	W 4 CC		0,5
1000 cc						
Roadster 1000	08.78-08.85	2	0 242 245 531	WR 5 BC		1,0
XLX-61	09.82-08.85	2	0 242 245 531	WR 5 BC		1,0
1100 cc						
XL 1100	01.79-12.85	2	0 242 235 665	WR 7 BC+		1,0
XR 1100	01.83-12.85	2	0 242 235 707	WR 7 DCX+		1,1
1130 cc						
V-Rod 1130	01.01-12.06	2	0 242 140 519	YR 6 DES		1,0
XLH 1100 Sportster	01.86-12.90	2	0 242 135 515	YR 7 DC+		1,0
1200 cc						
Electra Glide 1200	01.75-12.76	2	0 242 235 663	WR 7 DC+		0,6
ShovelHead 1200	01.75-08.81	2	0 242 229 687	WR 8 DCX+		1,1
Softail 1200	09.77-12.78	2	0 242 229 687	WR 8 DCX+		1,0
Sportster 1200	01.80-12.80	2	0 242 229 687	WR 8 DCX+		1,0
XL 1200 Nightster	01.08→	2	0 242 140 519	YR 6 DES		1,0
XL 1200R Sportster	01.04-12.08	2	0 242 135 515	YR 7 DC+		1,0
XR 1200 /X	01.08→	2	0 242 140 519	YR 6 DES		1,0
1250 cc						
VRSCAW 1250 V-Rod	01.08→	2	0 242 140 519	YR 6 DES		1,0
1340 cc						
Bad Boy 1340	09.84-12.89	2	0 242 229 687	WR 8 DCX+		1,0
Dyna Low Rider 1340	09.83-12.84	2	0 242 229 687	WR 8 DCX+		1,0
Dyna Wide Glide 1340	09.84-12.84	2	0 242 229 687	WR 8 DCX+		1,0
	01.85-12.85	2	0 242 229 687	WR 8 DCX+		1,0
Electra Glide 1340	09.83-12.98	2	0 242 229 687	WR 8 DCX+		1,0
Fat Boy 1340	01.90-12.98	2	0 242 229 656	WR 8 DC+		0,9
FL 1340 ShovelHead	01.78-12.84	2	0 242 229 687	WR 8 DCX+		1,1
FX 1340 ShovelHead	01.78-12.84	2	0 242 229 687	WR 8 DCX+		1,1
Sport Glide 1340	09.83-12.84	2	0 242 229 687	WR 8 DCX+		1,0
Tour Glide 1340	09.83-12.84	2	0 242 229 687	WR 8 DCX+		1,0
1580 cc						
Dyna 1580 Fat Bob	01.08→	2	0 242 140 519	YR 6 DES		1,0
Softail 1580 Rocker	01.08→	2	0 242 140 519	YR 6 DES		1,0





Typ



HERCULES (SACHS)

80 cc

RX 9	01.88-12.98	1	0 241 256 512	W 3 AC	0,5
Ultra RS 80 AC	01.82-12.92	1	0 241 245 580	W 5 AC	0,5
Ultra 80 AC	06.82-12.92	1	0 241 245 580	W 5 AC	0,5

HESKETH

1000 cc

V 1000	01.80-12.82	2	0 242 160 503	XR 2 CE 0	0,7
--------	-------------	---	---------------	-----------	-----

HIGHLAND

450 cc

450 MX	01.06-12.09	1	0 242 065 500	UR 09 CC	0,6
--------	-------------	---	---------------	----------	-----

950 cc

Allroad 950	01.04-12.09	2	0 242 065 500	UR 09 CC	0,6
Desert Storm 950	01.06-12.09	2	0 242 065 500	UR 09 CC	0,6
Dirt Track 950	01.07-12.09	2	0 242 065 500	UR 09 CC	0,6
Outback 950	01.03-12.09	2	0 242 065 500	UR 09 CC	0,6
Super Motard 950	01.07-12.09	2	0 242 065 500	UR 09 CC	0,6

HMZ

125 cc

Cruise 125	01.96→	1	0 241 150 504	X 4 CC	0,6
------------	--------	---	---------------	--------	-----

HONDA

70 cc

CRF 70 F	01.04→	1	0 242 055 501	UR 3 AC	0,7
CT 70	01.91-12.94	1	0 242 055 501	UR 3 AC	0,7
ST 70	01.90-12.96	1	0 242 055 501	UR 3 AC	0,7
XR 70 R	01.97-12.03	1	0 242 055 501	UR 3 AC	

75 cc

CRF 70 F	01.04→	1	0 242 055 501	UR 3 AC	
NSR 75	01.90-12.00	1	0 242 250 503	WR 4 CC	0,6

80 cc

CR 80	01.80-12.85	1	0 242 255 502	WR 3 CC	0,8
	01.86-12.95	1	0 242 274 501	WR 07 CS	0,6
CR 80 RB	01.96-12.02	1	0 242 274 501	WR 07 CS	0,6
CRF 80 F	01.04→	1	0 242 065 501	UR 09 AC	0,7
CY 80	01.80-12.81	1	0 242 060 506	UR 2 AC	0,7
MB 80	01.80-12.84	1	0 242 260 500	WR 2 AC	0,7
MBX 80	01.82-12.87	1	0 242 255 502	WR 3 CC	0,8
MCX 80	01.80-12.83	1	0 242 255 502	WR 3 CC	0,8
MT 80 F	01.80-12.85	1	0 242 268 500	WR 08 AC	0,7
MT 80 S	01.80-12.85	1	0 242 260 500	WR 2 AC	0,7
MTX 80 C	01.82-12.84	1	0 242 268 500	WR 08 AC	0,7



H



◀ HONDA

MTX 80 R	01.83-12.87	1	0 242 250 503	WR 4 CC	0,7
		1	0 242 255 502	WR 3 CC	0,7
NSR 80	01.87-12.99	1	0 242 250 503	WR 4 CC	0,8
XR 80	01.79-12.00	1	0 242 065 501	UR 09 AC	0,7
85 cc					
CR 85 R	01.03-12.07	1	0 242 274 501	WR 07 CS	0,6
CR 85 RB	01.03-12.07	1	0 242 274 501	WR 07 CS	
90 cc					
EZ 90 Cub	01.90-12.96	1	0 242 245 517	WR 5 AC	0,7
100 cc					
CRF 100 F	01.04→	1	0 242 065 501	UR 09 AC	0,7
XR 100	01.85-12.03	1	0 242 065 501	UR 09 AC	0,7
110 cc					
CG 110	01.77-12.81	1	0 242 150 507	XR 4 CC	0,7
125 cc					
CA 125 Rebel	01.95-12.99	2	0 242 055 501	UR 3 AC	0,7
CBR 125 R/RS/RW	01.04-12.06	1	0 242 068 500	UR 08 CC	0,7
	01.07-12.11	1	0 242 065 500	UR 09 CC	0,7
CG 125	01.76-12.97	1	0 242 150 507	XR 4 CC	0,6
	01.98-12.08	1	0 242 145 516	XR 5 DC	0,9
CLR 125 CityFly	01.98-12.03	1	0 242 145 516	XR 5 DC	0,9
CM 125 C	01.82-12.93	2	0 242 060 506	UR 2 AC	0,7
	01.94-12.99	2	0 242 065 501	UR 09 AC	0,7
CR 125 R	01.84-12.07	1	0 242 255 504	WR 3 CS	0,6
CRM 125	01.90-12.00	1	0 242 250 503	WR 4 CC	0,7
		1	0 242 255 504	WR 3 CS	0,7
MBX 125 F	01.83-12.86	1	0 242 255 502	WR 3 CC	0,7
MTX 125	01.83-12.95	1	0 242 255 502	WR 3 CC	0,7
NS 125 F	01.85-12.90	1	0 242 255 502	WR 3 CC	0,6
NS 125 R	01.87-12.93	1	0 242 255 502	WR 3 CC	0,6
NX 125	01.89-12.99	1	0 242 150 507	XR 4 CC	0,7
TL 125 S	01.76-12.79	1	0 242 150 507	XR 4 CC	0,6
VT 125 C Shadow	01.99-12.08	2	0 242 055 508	UHR 3 CC	0,9
VT 125 C2 Shadow	01.00-12.01	2	0 242 055 508	UHR 3 CC	0,9
XL 125 R	01.79-12.00	1	0 242 150 507	XR 4 CC	0,6
XL 125 Varadero	01.01→	2	0 242 055 508	UHR 3 CC	0,9
XLR 125 R	01.98-12.01	1	0 242 145 516	XR 5 DC	0,9
XR 125	01.98-12.98	1	0 242 150 507	XR 4 CC	0,7
XR 125 L	01.03-12.08	1	0 242 145 516	XR 5 DC	0,9
150 cc					
CRF 150 RB	01.07→	1	0 242 055 508	UHR 3 CC	0,9
185 cc					
CD 185 T	01.78-12.82	2	0 242 060 506	UR 2 AC	0,7
CM 185 T	01.77-12.85	2	0 242 060 506	UR 2 AC	0,7
XL 185 S	01.79-12.84	1	0 242 150 507	XR 4 CC	0,6
200 cc					
CD 200 T	01.79-12.86	2	0 242 060 506	UR 2 AC	0,7
CM 200	01.79-12.86	2	0 242 060 506	UR 2 AC	0,7
MTX 200 RW	01.83-12.88	1	0 242 255 502	WR 3 CC	0,7
TLM 220 R	08.88-12.98	1	0 242 250 503	WR 4 CC	0,7
		1	0 242 255 504	WR 3 CS	0,7
TR 200 Fat Cat	01.86-12.87	1	0 242 150 507	XR 4 CC	0,6
XL 200 R	01.79-12.86	1	0 242 150 507	XR 4 CC	0,7
XR 200	01.79-12.83	1	0 242 150 507	XR 4 CC	0,6
	01.86-12.02	1	0 242 150 507	XR 4 CC	0,6





Typ



250 cc						
CB 250	01.80-12.84		1	0 242 160 503	XR 2 CE 0	0,7
	01.91-12.08		2	0 242 055 501	UR 3 AC	0,7
CB 250 N	01.78-12.86		2	0 242 160 503	XR 2 CE 0	0,7
CB 250 T	01.77-12.78		2	0 242 150 507	XR 4 CC	0,7
CBF 250	01.04-12.08	WW	1	0 242 055 508	UHR 3 CC	0,9
CBX 250 RS	01.83-12.86		1	0 242 145 516	XR 5 DC	0,9
CD 250 U	01.88-12.93		2	0 242 055 501	UR 3 AC	0,7
CJ 250 T	01.76-12.79		2	0 241 248 538	W 4 CC	0,5
CM 250 C	01.82-12.85		2	0 242 060 506	UR 2 AC	0,7
CM 250 T	01.80-12.84		2	0 242 160 503	XR 2 CE 0	0,7
CMX 250 Rebel	01.96-12.03		2	0 242 055 501	UR 3 AC	0,7
CR 250 R	01.81-12.07		1	0 242 255 504	WR 3 CS	0,6
CRM 250 R	01.93-12.04		1	0 242 245 521	WR 5 CC	0,6
MVX 250	01.86-12.96			0 242 250 503	WR 4 CC	0,7
				0 242 255 504	WR 3 CS	0,7
NX 250	01.87-12.95		1	0 242 068 501	UHR 08 CC	0,9
VT 250	01.83-12.97		2	0 242 145 516	XR 5 DC	0,9
XL 250 R	01.82-12.83		1	0 242 150 507	XR 4 CC	0,7
XR 250 R	01.81-12.83		1	0 242 150 507	XR 4 CC	0,6
	01.96-12.04		1	0 242 068 501	UHR 08 CC	0,9
350 cc						
XL 350 R	01.84-12.88		1	0 242 145 516	XR 5 DC	0,9
XR 350 R	01.83-12.85		1	0 242 145 516	XR 5 DC	0,9
400 cc						
CB 400	01.78-12.85		2	0 242 160 503	XR 2 CE 0	0,7
CB-1	01.89-12.90		4	0 242 055 508	UHR 3 CC	0,9
CM 400 T	01.79-12.84		2	0 242 160 503	XR 2 CE 0	0,7
CX 400	01.81-12.83		2	0 242 150 507	XR 4 CC	0,7
NS 400 R	01.85-12.87		3	0 242 255 502	WR 3 CC	0,8
VF 400 F	01.82-12.86		4	0 242 145 516	XR 5 DC	0,9
XL 400 Transalp	01.82-12.98		2	0 242 150 507	XR 4 CC	0,7
450 cc						
CB 450 N	01.84-12.88		2	0 242 160 503	XR 2 CE 0	0,7
CB 450 S	01.86-12.90		2	0 242 150 507	XR 4 CC	0,7
CMX 450 Rebel	01.86-12.87		2	0 242 145 516	XR 5 DC	0,9
480 cc						
CR 480 R	01.82-12.83		1	0 242 255 504	WR 3 CS	0,5
500 cc						
CB 500	01.93-12.02		2	0 242 055 508	UHR 3 CC	0,9
CBR 500 F	01.87-12.90		4	0 242 145 516	XR 5 DC	0,9
CR 500 R	01.90-12.01		1	0 242 255 504	WR 3 CS	0,5
CX 500	01.77-12.84		2	0 242 150 507	XR 4 CC	0,7
FT 500	01.82-12.85		1	0 242 150 507	XR 4 CC	0,7
GB 500	01.86-12.92		1	0 242 145 516	XR 5 DC	0,9
GL 500	01.79-12.84		2	0 242 150 507	XR 4 CC	0,6
NX 500	01.88-12.99		1	0 242 145 516	XR 5 DC	0,9
VF 500	01.84-12.84		4	0 242 145 516	XR 5 DC	0,9
	01.85-12.87		4	0 242 150 505	XR 4 DC	0,9
VT 500	01.83-12.88		2	0 242 145 516	XR 5 DC	0,9
XBR 500 F	01.85-12.87		1	0 242 145 516	XR 5 DC	0,9
XBR 500 S	01.87-12.88		1	0 242 145 516	XR 5 DC	0,9
XL 500 R	01.82-08.85		1	0 242 150 507	XR 4 CC	0,7
XL 500 S	01.79-12.82		1	0 242 150 507	XR 4 CC	0,7





◀ HONDA

XR 500	01.79-12.80	1	0 242 150 507	XR 4 CC	0,7
	01.81-12.85	1	0 242 145 516	XR 5 DC	0,9
550 cc					
CBX 550	01.82-12.84	4	0 242 160 503	XR 2 CE 0	0,7
600 cc					
CB 600 F Hornet	01.07→	4	0 242 068 501	UHR 08 CC	0,9
CB 600 Hornet	01.98-12.06	4	0 242 068 501	UHR 08 CC	0,9
CBF 600	01.04-12.07	4	0 242 068 501	UHR 08 CC	0,9
	01.08→	4	0 242 055 508	UHR 3 CC	0,9
CBR 600 F	01.87-12.88	4	0 242 145 516	XR 5 DC	0,9
	01.89-12.90	4	0 242 150 505	XR 4 DC	0,9
	01.91-12.00	4	0 242 068 501	UHR 08 CC	0,9
CBX 600 E	01.83-12.87	4	0 242 145 516	XR 5 DC	0,9
NTV 600 Revere	01.88-12.92	2	0 242 145 516	XR 5 DC	0,9
NX 600	01.88-12.88	1	0 242 145 516	XR 5 DC	0,9
VT 600 C Shadow	01.88-12.04	2	0 242 145 516	XR 5 DC	0,9
XL 600 LM	01.85-12.87	1	0 242 145 516	XR 5 DC	0,9
XL 600 R	01.83-12.87	1	0 242 145 516	XR 5 DC	0,9
XL 600 RM	01.86-12.87	1	0 242 145 516	XR 5 DC	0,9
XL 600 V Transalp	01.87-12.00	2	0 242 145 516	XR 5 DC	0,9
XR 600	01.85-12.00	1	0 242 145 516	XR 5 DC	0,9
650 cc					
CB 650 Nighthawk	01.78-12.83	4	0 242 150 507	XR 4 CC	0,7
CB 650 SC Nighthawk	01.81-12.85	4	0 242 145 516	XR 5 DC	0,9
CBX 650	01.83-12.87	4	0 242 150 505	XR 4 DC	0,9
CX 650	01.83-12.85	2	0 242 145 516	XR 5 DC	0,9
FMX 650	01.05-12.06	1	0 242 145 516	XR 5 DC	0,9
FX 650 Vigor	01.99-12.03	1	0 242 145 516	XR 5 DC	0,9
GL 650	01.83-12.86	2	0 242 145 516	XR 5 DC	0,9
NT 650 V Deauville	01.98-12.05	2	0 242 145 516	XR 5 DC	0,9
NTV 650	01.88-12.97	2	0 242 145 516	XR 5 DC	0,9
NX 650 Dominator	01.88-12.99	1	0 242 145 516	XR 5 DC	0,9
SLR 650	01.97-12.99	1	0 242 145 516	XR 5 DC	0,9
XL 650 V Transalp	01.00-12.06	2	0 242 145 516	XR 5 DC	0,9
XR 650 Africa Twin	01.88-12.89	2	0 242 145 516	XR 5 DC	0,9
750 cc					
CB 750	01.92-12.03	4	0 242 145 516	XR 5 DC	0,9
CB 750 C	01.80-12.83	4	0 242 160 503	XR 2 CE 0	0,7
CB 750 F	01.79-12.84	4	0 242 160 503	XR 2 CE 0	0,7
CB 750 FZ	01.78-12.80	4	0 242 150 507	XR 4 CC	0,7
CB 750 F2	01.77-12.79	4	0 242 160 503	XR 2 CE 0	0,7
CB 750 K	01.80-12.83	4	0 242 160 503	XR 2 CE 0	0,7
CB 750 KZ	01.78-12.82	4	0 242 150 507	XR 4 CC	0,7
CBX 750	01.84-12.86	4	0 242 145 516	XR 5 DC	0,9
	01.87-12.01	4	0 242 150 505	XR 4 DC	0,9
NR 750	01.87-12.92	4	0 242 068 501	UHR 08 CC	0,9
VF 750	01.82-12.84	4	0 242 145 516	XR 5 DC	0,9
	01.85-12.88	4	0 242 150 505	XR 4 DC	0,9
	01.93-12.02	4	0 242 055 508	UHR 3 CC	0,9
VFR 750 F	01.86-12.87	4	0 242 145 516	XR 5 DC	0,9
	01.88-12.89	4	0 242 150 505	XR 4 DC	0,9
	01.90-12.97	4	0 242 055 508	UHR 3 CC	0,9
VFR 750 R	01.88-12.95	4	0 242 068 501	UHR 08 CC	0,9
VT 750 C Shadow	01.83-12.96	2	0 242 145 516	XR 5 DC	0,9
VT 750 DC Black Widow	01.01-12.03	2	0 242 145 516	XR 5 DC	0,9



XLV 750 R	01.83-12.89	2	0 242 145 516	XR 5 DC	0,9
XRV 750 Africa Twin	01.90-12.00	2	0 242 145 516	XR 5 DC	0,9
800 cc					
VFR 800	01.98-12.01	4	0 242 068 501	UHR 08 CC	0,9
900 cc					
CB 900	01.78-12.83	4	0 242 160 503	XR 2 CE 0	0,7
CB 900 Hornet	01.02-12.07	4	0 242 055 508	UHR 3 CC	0,9
CBR 900 RR Fireblade	01.92-12.99	4	0 242 068 501	UHR 08 CC	0,9
1000 cc					
CB 1000	01.93-12.96	4	0 242 150 505	XR 4 DC	0,9
CBF 1000	01.06→	4	0 242 055 508	UHR 3 CC	0,9
CBR 1000	01.87-12.99	4	0 242 150 505	XR 4 DC	0,9
CBX 1000	01.78-12.82	6	0 242 150 507	XR 4 CC	0,7
GL 1000 GoldWing	01.75-12.80	4	0 242 150 507	XR 4 CC	0,7
VF 1000 F	01.84-12.86	4	0 242 150 505	XR 4 DC	0,9
	01.87-12.87	4	0 242 145 516	XR 5 DC	0,9
VF 1000 F2	01.85-12.87	4	0 242 150 505	XR 4 DC	0,9
VF 1000 R	01.84-12.86	4	0 242 145 516	XR 5 DC	0,9
1100 cc					
CB 1100 F	01.81-12.84	4	0 242 160 503	XR 2 CE 0	0,7
CB 1100 R	01.81-12.84	4	0 242 160 503	XR 2 CE 0	0,7
GL 1100 GoldWing	01.80-12.81	4	0 242 150 507	XR 4 CC	0,7
	01.82-12.83	4	0 242 145 516	XR 5 DC	0,9
ST 1100 Pan-European	01.90-12.02	4	0 242 055 508	UHR 3 CC	0,9
VF 1100	01.83-12.86	4	0 242 145 516	XR 5 DC	0,9
1200 cc					
GL 1200 Gold Wing	01.84-12.88	4	0 242 145 516	XR 5 DC	0,9
1300 cc					
CB 1300	01.03→	4	0 242 145 516	XR 5 DC	0,9
CB 1300 X4	01.97-12.03	4	0 242 150 505	XR 4 DC	0,9
ST 1300 Pan-European	01.02→	4	0 242 055 508	UHR 3 CC	0,9

HRD

125 cc					
Cabriollet 125	01.99-12.02	1	0 242 068 500	UR 08 CC	0,7

HUSABERG

400 cc					
FE 400E	01.00-12.03	1	0 242 140 519	YR 6 DES	0,6
FS 400	01.00-12.03	1	0 242 140 519	YR 6 DES	0,6
450 cc					
FE 450E	01.00-12.08	1	0 242 140 519	YR 6 DES	0,6
470 cc					
FC 470	01.00-12.02	1	0 242 140 519	YR 6 DES	0,6
FX 470E	01.00-12.02	1	0 242 140 519	YR 6 DES	0,6
500 cc					
FE 501E	01.00-12.04	1	0 242 140 519	YR 6 DES	0,6
550 cc					
FC 550	01.00-12.05	1	0 242 140 519	YR 6 DES	0,6
FE 550E	01.03-12.08	1	0 242 140 519	YR 6 DES	0,6
FS 550E	01.00-12.08	1	0 242 140 519	YR 6 DES	0,6



◀ HUSABERG

650 cc					
FE 650 E	01.00-12.08	1	0 242 140 519	YR 6 DES	0,6
FS 650	01.00-12.08	1	0 242 140 519	YR 6 DES	0,6
FX 650 E	01.00-12.07	1	0 242 140 519	YR 6 DES	0,6

HUSQVARNA (CAGIVA)

125 cc					
CR 125	01.99→	1	0 242 255 504	WR 3 CS	0,5
SM 125	01.99→	1	0 242 255 504	WR 3 CS	0,5
TC 125	01.00→	1	0 242 255 504	WR 3 CS	0,5
WR 125	01.01→	1	0 242 255 504	WR 3 CS	0,5
WRE 125	01.95-12.02	1	0 241 256 515	W 3 CS	0,7
250 cc					
CR 250	01.01→	1	0 242 255 502	WR 3 CC	0,8
Military 250	01.81-12.91	1	0 241 248 538	W 4 CC	0,5
TC 250	01.01→	1	0 242 065 500	UR 09 CC	0,6
TE 250	01.01→	1	0 242 065 500	UR 09 CC	0,6
WR 250	01.99-12.10	1	0 241 256 515	W 3 CS	0,5
WRK 250/89	01.89-12.89	1	0 241 248 538	W 4 CC	0,5
350 cc					
WR 350	01.91-12.95	1	0 241 274 505	W 07 CS	0,5
360 cc					
WR 360	01.98→	1	0 241 256 515	W 3 CS	0,5
WXC 360	01.92→	1	0 241 256 515	W 3 CS	0,5
400 cc					
AE 420	01.81-12.84	1	0 241 248 538	W 4 CC	0,5
MX 390	01.78→	1	0 241 256 522	W 3 CC	0,5
SM 400 R	01.01→	1	0 242 065 500	UR 09 CC	0,6
TE 400	01.01-12.02	1	0 242 065 500	UR 09 CC	0,6
WR 400	01.85-08.89	1	0 241 248 538	W 4 CC	0,5
430 cc					
CR 430	01.86→	1	0 241 256 522	W 3 CC	0,5
WR 430 GS	01.83-12.93	1	0 241 248 538	W 4 CC	0,5
450 cc					
SM 450 R	01.03→	1	0 242 065 500	UR 09 CC	0,6
SMR 450	01.03-12.03	1	0 242 060 501	UR 2 CC	0,6
	01.04→	1	0 242 065 500	UR 09 CC	0,6
TC 450	01.02→	1	0 242 065 500	UR 09 CC	0,6
TE 450	01.03→	1	0 242 065 500	UR 09 CC	0,6
500 cc					
AE 500	01.84-12.84	1	0 241 248 538	W 4 CC	0,5
SM 510 R	01.05→	1	0 242 065 500	UR 09 CC	0,6
TC 510	01.05→	1	0 242 065 500	UR 09 CC	0,6
TE 510	01.03→	1	0 242 065 500	UR 09 CC	0,6
WR 500	01.84-12.84	1	0 241 248 538	W 4 CC	0,5
580 cc					
SMR 570	01.01-12.04	1	0 242 060 501	UR 2 CC	0,6
TC 570	07.01→	1	0 242 060 501	UR 2 CC	0,7
TE 570	07.01→	1	0 242 060 501	UR 2 CC	0,7
610 cc					
SM 610	01.07→	1	0 242 055 509	UR 3 DC	0,7
TC 610 Dual	01.05→	1	0 242 055 509	UR 3 DC	0,7





Typ



HYOSUNG

100 cc					
Cab 100	01.04→	1	0 241 245 656	W 5 BC	
EZ 100	01.04-12.05	1	0 241 245 656	W 5 BC	
Supercab 100	01.99-12.03	1	0 241 245 656	W 5 BC	
125 cc					
Cruise I 125	01.96-12.96	1	0 241 150 504	X 4 CC	0,6
	01.97-12.97	1	0 242 150 507	XR 4 CC	0,6
Cruise II 125 /Classic	01.97-12.03	1	0 242 055 508	UHR 3 CC	0,7
GF 125	01.98→	1	0 242 055 508	UHR 3 CC	0,8
GS 125	01.97-12.99	1	0 242 150 507	XR 4 CC	0,6
	01.00-12.05	1	0 242 150 507	XR 4 CC	0,7
GT 125 Naked	01.00→	2	0 242 065 500	UR 09 CC	0,6
GT 125R TTC	01.07→	2	0 242 065 500	UR 09 CC	0,6
GV 125 Aquila/M Cruiser	01.00→	2	0 242 065 500	UR 09 CC	0,6
Karion 125 /Citytrail	01.02→	1	0 242 055 508	UHR 3 CC	0,8
RX/XRX 125	01.99→	1	0 242 055 508	UHR 3 CC	0,8
250 cc					
GT 250	01.02-12.07	2	0 242 065 500	UR 09 CC	0,7
GV 250 Aquila	01.00-12.07	2	0 242 065 500	UR 09 CC	0,6
650 cc					
GT 650	01.04→	2	0 242 065 500	UR 09 CC	0,6
GV 650 /Aquila/Cruiser	01.04→	2	0 242 065 500	UR 09 CC	0,7
GV 650i	01.07→	2	0 242 065 500	UR 09 CC	0,6

INDIAN

1450 cc					
Chief 1450	01.99→	2	0 242 229 687	WR 8 DCX+	1,1
Scout 1450	01.01→	2	0 242 229 687	WR 8 DCX+	1,1
Spirit 1450	01.01→	2	0 242 229 687	WR 8 DCX+	1,1
1650 cc					
Chief 1650	01.02→	2	0 242 229 687	WR 8 DCX+	1,1

ITALJET

125 cc					
Buccaneer 125	01.75-12.78		0 241 245 581	W 5 CC	0,5
Super Ranger 120	01.89-12.89	1	0 241 245 580	W 5 AC	0,5
250 cc					
Trial T 250 Piuma	01.79-12.87	1	0 242 229 656	WR 8 DC+	0,6
330 cc					
HCH 350	01.83-12.93	1	0 241 235 089	W 7 CC	0,6
Roadmaster 350	12.82-12.85	1	0 241 235 089	W 7 CC	0,6
Trial T 350 Piuma	01.79-12.89	1	0 242 229 656	WR 8 DC+	0,6



Typ

**IZHMASH****350 cc**

6.113	01.90→	2	0 241 235 754	W 7 BC	0,7
7.107	01.04→	2	0 241 245 656	W 5 BC	0,7

JAWA**125 cc**

Dakar 125	01.03→	1	0 241 150 504	X 4 CC	0,7
Dandy 125	01.99→	1	0 241 150 504	X 4 CC	0,7
		1	0 242 160 503	XR 2 CE 0	0,8
Sport 125	01.03→	1	0 241 150 504	X 4 CC	0,7

350 cc

TS 350	09.86-12.98	2	0 241 235 607	W 7 AC	0,5
TS 350 Gespann	01.87-12.98	2	0 241 235 607	W 7 AC	0,5
638 350	01.84-12.86	2	0 241 235 607	W 7 AC	0,6
638.5 Gespann 350	01.85-12.86	2	0 241 235 607	W 7 AC	0,5
639 350	01.89-12.93	2	0 241 235 607	W 7 AC	0,6
639.2 Chopper	01.95-12.06	2	0 241 256 512	W 3 AC	0,5
640 Black Style 350	01.93-12.05	2	0 241 256 512	W 3 AC	0,5
640 Style 350	01.94-12.05	2	0 241 256 512	W 3 AC	0,5
500 cc					
500 R	09.86-12.90	1	0 241 150 504	X 4 CC	0,5
650 cc					
Classic 650	01.04→	1	0 242 150 507	XR 4 CC	0,7
Dakar 650	01.06→	1	0 242 150 507	XR 4 CC	0,7
Style 650	01.04→	1	0 242 150 507	XR 4 CC	0,7

JCM**125 cc**

125 Trial	01.87-12.95	1	0 241 235 755	W 7 DC	0,7
-----------	-------------	---	---------------	--------	-----

JINCHENG**70 cc**

CJ 70 A	01.94-12.99	1	0 242 055 501	UR 3 AC	0,7
90 cc					
JC 90	01.07→	1	0 242 055 501	UR 3 AC	0,7
100 cc					
JC 100-7	01.98-12.04	1	0 241 056 502	U 3 AC	0,6
125 cc					
JC 125-3A	01.97-12.04	1	0 241 150 504	X 4 CC	0,7
JC 125-7B	01.97-12.04	1	0 241 150 504	X 4 CC	0,7



Typ



KAWASAKI

60 cc						
KX 60	01.92-12.92	1	0 241 256 515	W 3 CS	0,6	
	01.93-12.03	1	0 242 255 504	WR 3 CS	0,7	
KX 65	01.00→	1	0 242 274 501	WR 07 CS	0,6	
80 cc						
KD 80	01.80-12.89	1	0 241 245 581	W 5 CC	0,7	
KDX 80	01.82-12.97	1	0 241 248 538	W 4 CC	0,8	
KMX 80	01.90-12.93	1	0 242 250 503	WR 4 CC	0,8	
KX 80	01.79-12.80	1	0 241 248 538	W 4 CC	0,8	
	01.81-12.82	1	0 241 256 522	W 3 CC	0,6	
	01.83-12.91	1	0 241 256 515	W 3 CS	0,6	
100 cc						
KC 100	01.79-12.86	1	0 241 248 538	W 4 CC	0,8	
KD 100	01.87-12.92	1	0 241 245 580	W 5 AC	0,7	
KE 100	01.76-12.79	1	0 241 248 538	W 4 CC	0,8	
	01.86-12.01	1	0 242 250 503	WR 4 CC	0,8	
KH 100 EX	01.81-12.93	1	0 241 248 538	W 4 CC	0,8	
KLX 110	01.02→	1	0 242 055 501	UR 3 AC		
KM 100	01.79-12.81	1	0 241 245 580	W 5 AC	0,7	
125 cc						
AR 125	01.82-12.94	1	0 242 250 503	WR 4 CC	0,8	
BN 125A Eliminator	01.98-12.07	1	0 242 065 500	UR 09 CC	0,6	
KDX 125 SR	01.90-12.94	1	0 242 250 503	WR 4 CC	0,8	
KE 125	01.76-12.83	1	0 241 256 512	W 3 AC	0,8	
	01.85-12.87	1	0 242 255 502	WR 3 CC	0,8	
KH 125	01.77-12.81	1	0 242 250 503	WR 4 CC	0,8	
	01.83-12.98	1	0 242 250 503	WR 4 CC	0,8	
KLX 125	12.09→	1	0 242 065 501	UR 09 AC	0,7	
KLX 125 D-Tracker	03.10→	1	0 242 065 501	UR 09 AC	0,7	
KMX 125	01.86-12.03	1	0 242 250 503	WR 4 CC	0,7	
175 cc						
KD 175	01.76-12.78	1	0 241 260 507	W 2 AC	0,7	
KE 175	01.75-12.80	1	0 241 260 507	W 2 AC	0,7	
	01.81-08.83	1	0 241 245 581	W 5 CC	0,8	
200 cc						
KDX 200	01.83-12.94	1	0 242 255 502	WR 3 CC	0,8	
	01.95-12.06	1	0 242 250 503	WR 4 CC	0,8	
KMX 200	01.87-12.92	1	0 242 250 503	WR 4 CC	0,8	
Z 200	01.77-12.79	1	0 241 248 538	W 4 CC	0,8	
250 cc						
BJ 250 Estrella	01.93-12.99	1	0 242 160 503	XR 2 CE 0	0,7	
EL 250 Eliminator	01.89-12.93	2	0 242 074 501	UR 07 AC	0,7	
EL 252 Eliminator	01.96-12.03	2	0 242 074 501	UR 07 AC	0,7	
GPX 250 R	01.88-12.95	2	0 242 074 501	UR 07 AC	0,7	
GPZ 250	01.83-12.85	2	0 242 145 516	XR 5 DC	0,9	
KDX 250	01.81-12.85	1	0 242 250 503	WR 4 CC	0,8	
KDX 250 D	01.91-12.94	1	0 242 255 502	WR 3 CC	0,8	
KDX 250 SR	01.89-12.92	1	0 242 250 503	WR 4 CC	0,8	
KE 250	01.77-12.79	2	0 241 248 538	W 4 CC	0,8	
KL 250	01.79-12.83	1	0 242 245 521	WR 5 CC	0,8	
KLR 250	01.84-12.91	1	0 242 150 505	XR 4 DC	0,9	
KLX 250	01.80-12.84	1	0 241 245 581	W 5 CC	0,8	



◀ KAWASAKI

KLX 250	01.93-12.98	1	0 242 065 500	UR 09 CC	0,8
	01.09→	1	0 242 065 500	UR 09 CC	0,7
KR-1 R/S	01.89-12.92	2	0 242 265 500	WR 09 CC	0,8
KT 250	01.75-12.80	1	0 241 245 580	W 5 AC	0,7
KX 250 F	01.04-12.10	1	0 242 065 500	UR 09 CC	0,7
Ninja 250 R	01.08→	2	0 242 065 500	UR 09 CC	0,7
Z 250 /A	01.79-12.79	2	0 242 245 521	WR 5 CC	0,8
	01.80-12.82	2	0 242 160 503	XR 2 CE 0	0,7
Z 250 B	01.80-12.83	2	0 242 160 503	XR 2 CE 0	0,7
Z 250 C	01.80-12.83	1	0 241 245 581	W 5 CC	0,8
Z 250 G	01.81-12.83	1	0 241 245 581	W 5 CC	0,8
Z 250 J	01.81-12.83	2	0 242 160 503	XR 2 CE 0	0,7
Z 250 LTD	01.81-12.83	1	0 242 250 503	WR 4 CC	0,8
Z 250 LTD Belt Drive	01.83-12.83	1	0 242 145 516	XR 5 DC	0,9
Z 250 T Scorpion	01.83-12.90	2	0 242 150 505	XR 4 DC	0,9
ZR 250 Balius	01.89-12.96	4	0 242 068 500	UR 08 CC	0,8
ZXR 250	01.89-12.96	4	0 242 068 500	UR 08 CC	0,8
ZZ-R 250	01.93-12.03	2	0 242 074 501	UR 07 AC	0,7
300 cc					
KLX 300	01.97-12.03	1	0 242 065 500	UR 09 CC	
	01.04-12.08	1	0 242 068 500	UR 08 CC	0,6
305 cc					
GPZ 305 Belt Drive	01.83-12.96	2	0 242 150 505	XR 4 DC	0,9
Z 305	01.81-12.81	2	0 241 150 504	X 4 CC	0,7
400 cc					
EN 400 Vulcan	01.85-12.92	2	0 242 160 503	XR 2 CE 0	0,7
GPX 400 R	01.87-12.97	4	0 242 150 505	XR 4 DC	0,9
GPZ 400	01.82-12.90	4	0 242 150 505	XR 4 DC	0,9
KH 400	01.75-12.81	3	0 241 256 512	W 3 AC	0,7
KLE 400	01.91-12.01	2	0 242 150 507	XR 4 CC	0,7
LTD 400	01.79-12.82	2	0 242 160 503	XR 2 CE 0	0,7
Xanthus ZR 400	01.92-12.95	4	0 242 074 500	UR 07 CDC	0,8
Z 400	01.79-12.83	2	0 241 245 581	W 5 CC	0,8
Z 400 F	01.83-12.83	4	0 242 160 503	XR 2 CE 0	0,7
	01.84-12.85	4	0 242 150 505	XR 4 DC	0,9
Z 400 J	01.80-12.83	4	0 241 150 504	X 4 CC	0,7
		4	0 242 150 507	XR 4 CC	0,7
Zephyr ZR 400	01.89-12.96	4	0 242 150 505	XR 4 DC	0,9
ZL 400 Eliminator	01.86-12.93	4	0 242 160 503	XR 2 CE 0	0,7
ZR 400	01.84-12.85	4	0 242 150 507	XR 4 CC	0,7
ZXR 400	01.89-12.03	4	0 242 074 500	UR 07 CDC	0,8
440 cc					
Z 440	01.80-12.85	2	0 242 245 521	WR 5 CC	0,8
450 cc					
EN 450 A	01.85-12.90	2	0 242 160 503	XR 2 CE 0	0,7
Z 450 LTD	01.85-12.90	2	0 242 160 503	XR 2 CE 0	0,7
500 cc					
EN 500	01.90-12.04	2	0 242 160 503	XR 2 CE 0	0,7
ER-5	08.96-12.05	2	0 242 160 503	XR 2 CE 0	0,7
GPX 500 R	01.88-12.00	4	0 242 160 503	XR 2 CE 0	0,7
GPZ 500 R	01.85-12.91	4	0 242 160 503	XR 2 CE 0	0,7
GPZ 500 S	09.86-12.89	2	0 242 160 503	XR 2 CE 0	0,7
	01.91-12.04	2	0 242 160 503	XR 2 CE 0	0,7
KLE 500	09.90-12.07	2	0 242 160 503	XR 2 CE 0	0,7
KLR 500	01.87-01.90	1	0 242 145 516	XR 5 DC	0,9



KX 500	01.83-12.03	1	0 242 255 504	WR 3 CS	0,6
Z 500	01.79-12.80	4	0 242 150 507	XR 4 CC	0,7
ZL 500 Eliminator	01.86-12.94	4	0 242 160 503	XR 2 CE 0	0,7
ZZ-R 500	01.91-12.91	4	0 242 068 500	UR 08 CC	0,8
550 cc					
GPZ 550	01.80-12.91	4	0 242 150 505	XR 4 DC	0,9
GT 550	01.83-12.01	4	0 242 160 503	XR 2 CE 0	0,7
KZ 550	01.80-12.83	4	0 241 150 504	X 4 CC	0,7
LTD 550	01.80-12.85	4	0 242 160 503	XR 2 CE 0	0,7
Z 550	01.80-12.97	4	0 242 160 503	XR 2 CE 0	0,7
ZR 550 Zephyr	01.90-12.99	4	0 242 160 503	XR 2 CE 0	0,7
ZX 550	01.84-12.86	4	0 242 150 505	XR 4 DC	0,9
600 cc					
GPX 600 R	01.88-12.90	4	0 242 160 503	XR 2 CE 0	0,8
GPZ 600 R	01.84-12.90	4	0 242 160 503	XR 2 CE 0	0,7
KLR 600	01.83-12.84	1	0 242 160 503	XR 2 CE 0	0,7
	01.85-12.90	1	0 242 145 516	XR 5 DC	0,9
ZL 600 Eliminator	01.86-03.90	4	0 242 160 503	XR 2 CE 0	0,7
	01.95-12.98	4	0 242 160 503	XR 2 CE 0	0,7
ZX-6R Ninja	01.95-12.01	4	0 242 068 500	UR 08 CC	0,8
	01.07→	4	0 242 068 500	UR 08 CC	0,8
ZX-6R 600	01.94-12.94	4	0 242 068 500	UR 08 CC	
ZX-6RR Ninja	01.02-12.06	4	0 242 068 500	UR 08 CC	0,8
ZZ-R 600	01.90-12.09	4	0 242 068 500	UR 08 CC	0,8
650 cc					
KLR 650	09.86→	1	0 242 145 516	XR 5 DC	0,9
KLR 650 Tengai	09.88-12.93	1	0 242 145 516	XR 5 DC	0,9
KLX 650	01.92-12.96	1	0 242 145 516	XR 5 DC	0,9
KLX 650 R	01.96-12.01	1	0 242 145 516	XR 5 DC	0,9
W 650	01.99-12.06	2	0 242 068 500	UR 08 CC	0,8
Z 650	01.76-12.80	4	0 242 245 521	WR 5 CC	0,8
Z 650 F	01.81-12.83	4	0 241 248 538	W 4 CC	0,7
ZX-6R Ninja	01.02-12.06	4	0 242 068 500	UR 08 CC	0,8
700 cc					
Z 700	01.84-12.84	4	0 242 250 503	WR 4 CC	0,8
ZN 700 LTD	01.83-12.86	4	0 242 250 503	WR 4 CC	0,8
750 cc					
GPX 750 R	01.87-12.91	4	0 242 150 507	XR 4 CC	0,7
		4	0 242 160 503	XR 2 CE 0	0,7
GPZ 750	01.82-12.88	4	0 242 255 502	WR 3 CC	0,8
GPZ 750 R	01.85-12.86	4	0 242 160 503	XR 2 CE 0	0,7
GPZ 750 Turbo	01.85-12.87	4	0 242 250 503	WR 4 CC	0,8
		4	0 242 255 504	WR 3 CS	0,8
GT 750	01.82-12.91	4	0 242 250 503	WR 4 CC	0,8
	01.92-12.96	4	0 242 160 503	XR 2 CE 0	0,7
Z 750	01.80-12.87	4	0 242 250 503	WR 4 CC	0,8
	01.04→	4	0 242 074 500	UR 07 CDC	0,7
Z 750 Belt Drive	01.82-12.84	2	0 242 235 663	WR 7 DC+	0,8
Z 750 D	01.76-12.76	2	0 241 248 538	W 4 CC	0,8
Z 750 Twin	01.77-12.82	2	0 242 250 503	WR 4 CC	0,8
Zephyr 750	01.91-12.99	4	0 242 160 503	XR 2 CE 0	0,7
ZL 750 Eliminator	01.86-12.89	4	0 241 150 504	X 4 CC	
ZR 750 S	01.05-12.07	4	0 242 074 500	UR 07 CDC	0,7
ZR-7 F	01.99-12.04	4	0 242 160 503	XR 2 CE 0	0,7
ZR-7 S	01.01-12.04	4	0 242 160 503	XR 2 CE 0	0,7



◀ KAWASAKI

ZXR 750	09.88-12.90	4	0 242 068 500	UR 08 CC	0,8
ZXR 750 R	01.91-12.95	4	0 242 068 500	UR 08 CC	0,8
ZX-7R Ninja	01.96-12.03	4	0 242 068 500	UR 08 CC	0,8
ZX-7RR Ninja 800 cc	01.96-12.00	4	0 242 068 500	UR 08 CC	0,8
VN 800 A/B	01.95-12.06	2	0 242 060 501	UR 2 CC	0,8
VN 800 Drifter	01.99-12.03	2	0 242 060 501	UR 2 CC	0,8
VN 800 Vulcan	01.95-12.01	2	0 242 065 500	UR 09 CC	0,8
W 800 900 cc	01.11→	2	0 242 065 500	UR 09 CC	0,7
GPZ 900 R	01.84-12.96	4	0 242 160 503	XR 2 CE 0	0,7
ZX-9R Ninja 1000 cc	09.93-12.03	4	0 242 074 500	UR 07 CDC	0,7
GPZ 1000 R/RX	01.86-12.89	4	0 242 160 503	XR 2 CE 0	0,7
GTR 1000	01.86-12.01	4	0 242 160 503	XR 2 CE 0	0,7
KLV 1000	01.04-12.08	2	0 242 060 505	UR 2 CDC	0,7
KZ 1000 Police	01.82-12.05	4	0 242 250 503	WR 4 CC	0,8
Z 1-R	01.78-12.80	4	0 241 248 538	W 4 CC	0,7
Z 1000	01.03-12.06	4	0 242 074 500	UR 07 CDC	
Z 1000 A	01.77-12.80	4	0 241 248 538	W 4 CC	0,8
Z 1000 J	01.81-12.83	4	0 242 250 503	WR 4 CC	0,8
Z 1000 ST	01.79-12.82	4	0 242 250 503	WR 4 CC	0,8
ZL 1000 Eliminator	09.86-12.90	4	0 242 160 503	XR 2 CE 0	0,7
ZX-10 1100 cc	01.88-12.90	4	0 242 068 500	UR 08 CC	0,8
GPZ 1100	01.81-12.88	4	0 242 250 503	WR 4 CC	0,8
	01.95-12.98	4	0 242 074 500	UR 07 CDC	0,8
LTD 1100	01.81-12.85	4	0 242 250 503	WR 4 CC	0,8
Z 1100	01.81-12.85	4	0 242 250 503	WR 4 CC	0,8
Zephyr 1100	01.91-12.97	4	0 242 068 500	UR 08 CC	0,8
ZRX 1100	01.97-12.00	4	0 242 074 500	UR 07 CDC	0,8
ZX-11 Ninja	01.97-12.01	4	0 242 068 500	UR 08 CC	
ZZ-R 1100 1200 cc	01.90-12.01	4	0 242 068 500	UR 08 CC	0,8
ZG 1200 A Voyager XII	01.86-12.03	4	0 242 145 516	XR 5 DC	0,9
ZRX 1200	01.01-12.06	4	0 242 074 500	UR 07 CDC	0,7
ZZ-R 1200 1300 cc	01.02-12.05	4	0 242 068 500	UR 08 CC	0,7
Z 1300	01.79-12.83	6	0 241 248 538	W 4 CC	0,8
Z 1300 DFI	01.80-12.88	6	0 242 235 663	WR 7 DC+	0,8
ZG 1300	01.85-12.90	6	0 242 235 663	WR 7 DC+	0,7

KREIDLER

80 cc

Florett 80	01.81-06.82	1	0 241 256 512	W 3 AC	0,4
Mustang 80 125 cc	01.81-06.82	1	0 241 256 512	W 3 AC	0,4
Enduro 125 D	01.07→	1	0 242 065 500	UR 09 CC	0,7
Mustang 125	01.82-12.84	1	0 242 150 507	XR 4 CC	0,7
Supermoto 125	01.07→	1	0 242 065 500	UR 09 CC	0,7



Typ



KTM

80 cc						
Bora 80	10.81-12.91		1	0 241 256 512	W 3 AC	0,6
Chopper 80	01.82-12.87		1	0 241 260 507	W 2 AC	0,6
Enduro 80	01.80-12.89		1	0 241 274 505	W 07 CS	0,6
PL	06.83-12.84		1	0 241 256 512	W 3 AC	0,6
RL 80	10.81-12.91		1	0 241 256 512	W 3 AC	0,6
RLS 80	10.81-12.91		1	0 241 260 507	W 2 AC	0,6
RLW 80	10.81-12.91		1	0 241 260 507	W 2 AC	0,6
RS 80	10.81-12.91		1	0 241 256 512	W 3 AC	0,6
125 cc						
125 Enduro	01.91-12.01		1	0 241 274 505	W 07 CS	0,6
125 EXE	01.00→		1	0 242 260 500	WR 2 AC	0,6
125 LC 2	01.96-12.99		1	0 242 255 502	WR 3 CC	0,6
	01.00→		1	0 242 260 500	WR 2 AC	0,6
125 Sting	01.97-12.00		1	0 242 250 503	WR 4 CC	0,7
125 Supermoto	01.99→		1	0 242 260 500	WR 2 AC	0,6
125 SX	01.96-08.97		1	0 242 274 501	WR 07 CS	0,6
200 cc						
200 EGS	01.98-12.05		1	0 242 255 504	WR 3 CS	0,6
200 EXC	01.98→		1	0 242 255 504	WR 3 CS	0,6
200 MXC	01.98→		1	0 242 255 504	WR 3 CS	0,6
250 cc						
250 Enduro	01.87→		1	0 241 274 505	W 07 CS	0,6
250 EXC Enduro Competition	01.03→		1	0 242 245 521	WR 5 CC	0,6
250 EXC Racing	01.02-12.02		1	0 242 060 505	UR 2 CDC	0,6
	01.03→		1	0 242 140 519	YR 6 DES	0,6
250 MC	01.77→	XJB	1	0 241 260 507	W 2 AC	0,6
		XJC	1	0 241 256 515	W 3 CS	0,6
250 SX	01.96-12.96		1	0 242 255 504	WR 3 CS	0,6
300 cc						
300 EXC Enduro Competition	01.03→		1	0 242 245 521	WR 5 CC	0,6
300 GS	01.84-12.95	XJB	1	0 241 260 507	W 2 AC	0,6
300 LC	01.90-12.98		1	0 241 274 505	W 07 CS	0,6
300 MXC	01.03→		1	0 242 245 521	WR 5 CC	0,6
350 cc						
350 EGS LC4	01.93→		1	0 241 150 504	X 4 CC	0,6
350 EXC LC4	01.93→		1	0 241 150 504	X 4 CC	0,6
350 LC 4	01.91-12.03		1	0 241 150 504	X 4 CC	0,6
360 cc						
360 SX	01.96-12.96		1	0 242 255 504	WR 3 CS	0,6
390 cc						
390	01.80→		1	0 241 256 515	W 3 CS	0,6
400 cc						
LC4 400 EXC	01.93-12.97		1	0 241 150 504	X 4 CC	0,6
400 EGS	01.93→		1	0 241 150 504	X 4 CC	0,6
400 EGS-E	01.97-12.98		1	0 242 150 507	XR 4 CC	0,6
400 Enduro-E	01.92→		1	0 241 150 504	X 4 CC	0,6
400 EXC Racing	01.99-04.02		1	0 242 060 505	UR 2 CDC	0,7
	05.02→		1	0 242 140 519	YR 6 DES	0,6
400 GS	01.75→		4	0 241 260 507	W 2 AC	0,6
400 LC 4	01.94-04.02		4	0 242 150 507	XR 4 CC	0,7
	05.02→		4	0 242 140 519	YR 6 DES	0,6





◀ KTM

400 LC 4 Competition	01.95-12.99	1	0 242 150 507	XR 4 CC	0,7
400 LC 4 Enduro	01.95→	4	0 242 150 507	XR 4 CC	0,7
400 LSE	01.97-12.98	1	0 242 150 507	XR 4 CC	0,6
400 MC	01.75→	4	0 241 260 507	W 2 AC	0,6
400 SC	01.95→	4	0 241 150 504	X 4 CC	0,6
400 Super Competition	01.95-12.00	1	0 241 150 504	X 4 CC	0,6
400 SX	01.98-04.02	4	0 241 150 504	X 4 CC	0,6
400 SX Racing	01.00-04.02	4	0 242 060 505	UR 2 CDC	0,7
	05.02→	4	0 242 140 519	YR 6 DES	0,6
400 SXC	01.97-04.02	4	0 241 150 504	X 4 CC	0,6
420 cc					
420	01.79→	1	0 241 256 515	W 3 CS	0,6
450 cc					
450 EXC Racing	01.03→	1	0 242 140 519	YR 6 DES	0,6
450 MXC	01.03→	1	0 242 140 519	YR 6 DES	0,6
450 SMR	01.04→	1	0 242 140 519	YR 6 DES	0,6
450 SX Racing	01.03→	1	0 242 140 519	YR 6 DES	0,6
495 cc					
495	01.82→	1	0 241 256 515	W 3 CS	0,6
500 cc					
500 DXC	01.89→	1	0 241 256 522	W 3 CC	0,6
500 EXC	01.00→	1	0 241 256 522	W 3 CC	0,6
500 GS 2T	01.82→	1	0 241 274 505	W 07 CS	0,6
500 GS 4T	01.82→	1	0 241 150 504	X 4 CC	0,6
510 cc					
525 XC Desert Racing	01.07-12.07	1	0 242 140 519	YR 6 DES	0,6
520 cc					
520 EXC Racing	01.99-04.02	1	0 242 060 505	UR 2 CDC	0,7
	05.02→	1	0 242 140 519	YR 6 DES	0,6
520 SX Racing	01.99-04.02	1	0 242 060 505	UR 2 CDC	0,7
	05.02→	1	0 242 140 519	YR 6 DES	0,6
525 cc					
525 EXC Racing	01.03→	1	0 242 140 519	YR 6 DES	0,6
525 MXC	01.03→	1	0 242 140 519	YR 6 DES	0,6
525 SMR	01.04→	1	0 242 140 519	YR 6 DES	0,6
525 SX Racing	01.03→	1	0 242 140 519	YR 6 DES	0,6
540 cc					
540 MX	01.90→	1	0 241 256 522	W 3 CC	0,6
540 SXC	01.98→	1	0 241 150 504	X 4 CC	0,6
540 SXC Racing	01.02→	1	0 242 060 505	UR 2 CDC	0,7
565 cc					
560 SMR	01.07→	1	0 242 140 519	YR 6 DES	0,6
600 cc					
600 LC 4 EXC	01.88→	1	0 241 150 504	X 4 CC	0,6
600 LC4 EGS	01.89→	1	0 241 150 504	X 4 CC	0,6
600 LC4 Enduro	01.87-12.93	1	0 241 150 504	X 4 CC	0,6
600 MX	01.87→	1	0 241 150 504	X 4 CC	0,6
620 LC 4 Super Competition	05.02→	1	0 242 140 519	YR 6 DES	0,6
620 Super Competition	01.95-12.00	1	0 241 150 504	X 4 CC	0,6
	01.01-04.02	1	0 242 150 507	XR 4 CC	0,7
612 cc					
612 LC 4 EGS	01.93→	1	0 241 150 504	X 4 CC	0,6
612 LC 4 EXC	01.93→	1	0 241 150 504	X 4 CC	0,6



620 cc						
620 Duke	01.93-12.98	1	0 241 150 504	X 4 CC	0,6	
620 E Duke	01.96-12.98	1	0 242 150 507	XR 4 CC	0,6	
620 EGS	01.94→	1	0 241 150 504	X 4 CC	0,6	
620 EGS-E	01.97→	1	0 242 150 507	XR 4 CC	0,6	
620 EXC	01.94→	1	0 241 150 504	X 4 CC	0,6	
620 LC 4 Supermoto	01.98-12.00	1	0 241 150 504	X 4 CC	0,6	
	01.01→	1	0 242 150 507	XR 4 CC	0,7	
620 LS E	01.97→	1	0 242 150 507	XR 4 CC	0,6	
620 LS4 Rally	01.97→	1	0 241 150 504	X 4 CC	0,6	
620 SC	01.96→	1	0 241 150 504	X 4 CC	0,6	
620 SX	01.94→	1	0 241 150 504	X 4 CC	0,6	
625 cc						
625 SMC	01.05→	1	0 242 140 519	YR 6 DES	0,6	
625 SXC	01.02→	1	0 242 140 519	YR 6 DES	0,6	
640 Duke I	01.98-12.01	1	0 242 150 507	XR 4 CC	0,7	
	01.02→	1	0 242 140 519	YR 6 DES	0,6	
640 Duke II	01.99-12.01	1	0 242 150 507	XR 4 CC	0,7	
	05.02→	1	0 242 140 519	YR 6 DES	0,6	
640 LC 4	01.98-12.01	1	0 242 150 507	XR 4 CC	0,7	
640 LC 4 Adventure	01.01-12.01	1	0 242 150 507	XR 4 CC	0,7	
	05.02→	1	0 242 140 519	YR 6 DES	0,6	
640 LC 4 Adventure R	01.98-12.01	1	0 242 150 507	XR 4 CC	0,7	
	01.02→	1	0 242 140 519	YR 6 DES	0,6	
640 LC 4 Hard Enduro	01.03→	1	0 242 140 519	YR 6 DES	0,6	
640 LC 4 Prestige Supermoto	01.03→	1	0 242 140 519	YR 6 DES	0,6	
640 LC 4 SM	01.05→	1	0 242 140 519	YR 6 DES	0,6	
640 LC 4-E	01.02→	1	0 242 140 519	YR 6 DES	0,6	
640 LC 4-E Enduro	01.99→	1	0 242 150 507	XR 4 CC	0,7	
640 LC 4-E Supermoto	01.99-12.01	1	0 242 150 507	XR 4 CC	0,7	
	05.02→	1	0 242 140 519	YR 6 DES	0,6	
660 cc						
660 LC4 Rallye	01.96-12.99	1	0 242 150 507	XR 4 CC	0,6	
	01.02-04.02	1	0 242 160 503	XR 2 CE 0	0,6	
	05.02-12.02	1	0 242 140 519	YR 6 DES	0,6	
	01.03→	1	0 242 160 503	XR 2 CE 0	0,6	
660 SMC Supermoto	01.03-12.04	1	0 242 160 503	XR 2 CE 0	0,6	
	01.05→	1	0 242 140 519	YR 6 DES	0,6	
950 cc						
LC8 950 Rally	01.02→	2	0 242 060 505	UR 2 CDC	0,7	
950 Adventure	01.03→	2	0 242 060 505	UR 2 CDC	0,7	
950 Adventure S	01.03→	2	0 242 060 505	UR 2 CDC	0,7	
950 Super Enduro R	01.05→	2	0 242 060 505	UR 2 CDC	0,7	
950 Supermoto	01.05→	2	0 242 060 505	UR 2 CDC	0,7	
950 Supermoto R	01.06→	2	0 242 060 505	UR 2 CDC	0,7	
990 cc						
990 Duke	09.04→	2	0 242 140 519	YR 6 DES	0,6	
1000 cc						
990 Adventure	01.06→	2	0 242 140 519	YR 6 DES	0,6	
990 Superduke	01.05-12.06	2	0 242 140 519	YR 6 DES	0,6	



Typ



KYMCO

100 cc					
Cobra 100	01.95-12.04	1	0 242 245 577	WR 5 BC 0	
125 cc					
Hipster 125 2V	01.01-12.06	1	0 242 150 507	XR 4 CC	0,7
Hipster 125 4V	01.99-12.06	1	0 242 065 500	UR 09 CC	0,7
Pulsar 125	01.01→	1	0 242 150 507	XR 4 CC	0,7
Quannon 125	01.06→	1	0 242 065 500	UR 09 CC	0,7
Stryker 125 Offroad	01.99→	1	0 242 150 507	XR 4 CC	0,7
Stryker 125 Onroad	01.99→	1	0 242 150 507	XR 4 CC	0,7
150 cc					
Stryker 150	01.99-12.05	1	0 242 150 507	XR 4 CC	

LAVERDA

125 cc					
CU Ride	12.85-12.88	1	0 241 248 538	W 4 CC	0,5
GS Lesmo	02.86-12.88	1	0 241 248 538	W 4 CC	0,5
GSR 125	01.88-12.98	1	0 241 256 515	W 3 CS	0,5
		1	0 242 255 502	WR 3 CC	0,5
LB Custom	11.83-11.87	1	0 241 256 522	W 3 CC	0,5
LB Sport	11.83-11.85	1	0 242 250 503	WR 4 CC	0,6
LB Standard	11.83-11.85	1	0 242 250 503	WR 4 CC	0,6
LB Strada 125	11.83-11.87	1	0 241 256 522	W 3 CC	0,5
LB UNO	01.87-12.97	1	0 241 248 538	W 4 CC	0,5
LB 1 Custom	10.84-12.94	1	0 242 250 503	WR 4 CC	0,6
LB 1 Sport	10.84-12.94	1	0 242 250 503	WR 4 CC	0,6
LZ 125	12.77-01.84	1	0 241 256 515	W 3 CS	0,6
		1	0 242 255 502	WR 3 CC	0,7
Navarro 125	01.90-06.92	1	0 241 256 515	W 3 CS	0,6
		1	0 242 255 502	WR 3 CC	0,6
Toledo 125	01.90-06.92	1	0 242 250 503	WR 4 CC	0,6
250 cc					
T 2 250	01.78-12.88	1	0 242 250 503	WR 4 CC	0,7
600 cc					
OR 600 Atlas	06.86-12.88	2	0 241 150 504	X 4 CC	0,6
660 cc					
Sport 668	01.95-12.98	2	0 242 150 506	YR 4 DE	0,6
668	01.95-12.98	2	0 242 150 506	YR 4 DE	0,6
668 Ghost	01.96-12.98	2	0 242 150 506	YR 4 DE	0,6
750 cc					
750 Cafe Racer	01.97-12.02	2	0 242 150 506	YR 4 DE	
750 Formula S	01.97-12.02	2	0 242 150 506	YR 4 DE	0,6
750 S	01.97-12.02	2	0 242 150 506	YR 4 DE	
750 SF 3	10.75-10.76	2	0 241 248 538	W 4 CC	0,5
750 Strike	01.97-12.02	2	0 242 150 506	YR 4 DE	
1000 cc					
Jota Executiv	05.83-12.90	3	0 242 250 503	WR 4 CC	0,6
M-BTZ 1000	08.77-06.80	3	0 242 250 503	WR 4 CC	0,6
RGS	03.82-12.90	3	0 241 248 538	W 4 CC	0,6
RGS Corsa	05.83-12.93	3	0 242 250 503	WR 4 CC	0,6
RGS Jarama	03.82→	3	0 241 248 538	W 4 CC	0,6



RGS Jota	01.85-12.95	3	0 241 248 538	W 4 CC	0,6
RGS/2	01.85-12.95	3	0 242 250 503	WR 4 CC	0,6
SFC 1000	06.85-12.95	3	0 241 256 515	W 3 CS	0,5
		3	0 242 255 502	WR 3 CC	0,5
	01.04→	2	0 241 256 522	W 3 CC	0,5
3 CL	10.75-03.82	3	0 241 248 538	W 4 CC	0,6
1200 cc					
Mirage 1200	01.79-03.82	3	0 241 248 538	W 4 CC	0,6
TS 1200	01.79-03.82	3	0 241 248 538	W 4 CC	0,6
1200	01.76-12.89	4	0 241 248 538	W 4 CC	0,6

LIFAN

70 cc					
LF 70 GY	01.04-12.06	1	0 241 056 502	U 3 AC	0,6
90 cc					
LF 90 GY	01.06→	1	0 241 056 502	U 3 AC	0,6
100 cc					
LF 100 GY	01.04→	1	0 241 056 502	U 3 AC	0,6
110 cc					
LF 110 GY	01.06→	1	0 241 056 502	U 3 AC	0,6
125 cc					
LF 125 GY	01.04→	1	0 242 145 516	XR 5 DC	0,9
LF 125 T	01.04→	1	0 241 056 502	U 3 AC	0,6
150 cc					
LF 150 GY	01.06→	1	0 242 145 516	XR 5 DC	0,9
200 cc					
LF 200	01.06→	1	0 242 145 516	XR 5 DC	0,9
LF 200 B	01.08→	1	0 242 145 516	XR 5 DC	0,9
LF 200 GY	01.06→	1	0 242 145 516	XR 5 DC	0,9
250 cc					
LF 250	01.06→	2	0 242 055 501	UR 3 AC	0,7
LF 250 B	01.07→	2	0 242 055 501	UR 3 AC	0,7

MAGNI

1000 cc					
Sfida 1000	01.89-12.97	2	0 241 235 755	W 7 DC	0,6

MAICO

250 cc					
GM Star 250	01.85-12.95	1	0 241 256 522	W 3 CC	0,5
GM Star 250 E	01.85-12.95	1	0 241 256 522	W 3 CC	0,5
GS 250	01.92-12.02	1	0 241 256 522	W 3 CC	0,5
320 cc					
320	01.89-12.03	1	0 241 256 522	W 3 CC	0,6
450 cc					
440	01.94→	1	0 241 256 522	W 3 CC	0,6



Typ



◀ MAICO

500 cc					
GM Star 500	01.85-12.95	1	0 241 256 522	W 3 CC	0,5
GM Star 500 E	01.85-12.95	1	0 241 256 522	W 3 CC	0,5
GP 500 E	01.85-12.97	1	0 241 256 522	W 3 CC	0,5

MALAGUTI

75 cc					
Dune 75	01.96-12.06	1	0 241 245 581	W 5 CC	0,5
80 cc					
Cavalcone	12.81-08.92	1	0 241 248 538	W 4 CC	0,5
Chopper	01.82-12.02	1	0 241 248 538	W 4 CC	0,5
Cross 80	01.82-12.92	1	0 241 248 538	W 4 CC	0,5
125 cc					
Cross 125	01.75-12.79	1	0 241 248 538	W 4 CC	0,5
Runner 125 Rally	06.86-12.96	1	0 241 256 522	W 3 CC	0,5
Runner 125 YLC	06.86-12.96	1	0 241 248 538	W 4 CC	0,5

MALANCA

125 cc					
ob one M 6 Racing	01.85-12.95	2	0 241 260 507	W 2 AC	0,5
125 GTI Strada	01.80-12.90		0 241 260 507	W 2 AC	0,5
125 Mark	01.85-12.95	2	0 241 260 507	W 2 AC	0,5
125 Sport	01.78-12.82	2	0 242 245 517	WR 5 AC	0,5
150 cc					
150 GT Strada	12.81-12.83	2	0 242 245 517	WR 5 AC	0,5
150 3 GTI	01.78-12.81	2	0 242 245 517	WR 5 AC	0,5
150 3 GTS	01.78-12.81	2	0 242 245 517	WR 5 AC	0,5

MBK

80 cc					
Evolis 80	01.92→	1	0 242 245 517	WR 5 AC	0,7

MECATECNO

330 cc					
Dragon Fly 330	01.86-12.90	1	0 241 229 715	W 8 DC	0,5
MR 326	01.85-12.90	1	0 241 229 715	W 8 DC	0,5
Sky Walker 330	01.88-12.93	1	0 241 229 715	W 8 DC	0,5

MERLIN

125 cc					
DG 7 125	09.86-12.91	1	0 241 229 715	W 8 DC	0,5
350 cc					
DG 3.50	09.83-12.88	1	0 241 229 715	W 8 DC	0,5
DG3 FIUS 350	09.86-12.91	1	0 241 229 715	W 8 DC	0,5



450 cc						
Nomada 500	09.87-12.97	1	0 241 150 504	X 4 CC		0,5

MIDWEST

70 cc						
JC70Y	01.00→	1	0 242 055 501	UR 3 AC		0,7
JS70Y	01.00→	1	0 242 055 501	UR 3 AC		0,7
90 cc						
JS90Y	01.00→	1	0 242 055 501	UR 3 AC		0,7

MINSK

125 cc						
MMVZ 3.112	01.76-12.87	1	0 241 245 656	W 5 BC		0,7
MMVZ 3.113	01.76-12.87	1	0 241 245 656	W 5 BC		0,7
MMVZ 3.901	01.76-12.87	1	0 241 245 656	W 5 BC		0,7

MONTESA

125 cc						
Crono 125	01.78-12.85	1	0 241 248 538	W 4 CC		0,5
Enduro 125	01.76-12.85	1	0 241 248 538	W 4 CC		0,5
MH 123	01.80-12.85	1	0 242 245 552	WR 5 DC+		0,6
175 cc						
Impala 2 175	01.82-12.86	1	0 241 245 580	W 5 AC		0,5
MH 200	01.80-12.85	1	0 242 245 552	WR 5 DC+		0,6
250 cc						
Cota 248	01.80-12.85	1	0 241 229 715	W 8 DC		0,5
Enduro 250 H6	01.77-12.83	1	0 241 248 538	W 4 CC		0,5
Enduro 250 H7	01.84-12.89	1	0 241 274 505	W 07 CS		0,5
260 cc						
Cota 309	01.88-12.93	1	0 242 245 552	WR 5 DC+		0,6
Cota 310	01.91-12.95	1	0 242 245 552	WR 5 DC+		0,6
Cota 311	01.93-12.98	1	0 242 229 656	WR 8 DC+		0,6
300 cc						
Cota 348	01.76-12.85	1	0 241 229 715	W 8 DC		0,5
330 cc						
Cota 330	01.80-12.85	1	0 241 229 715	W 8 DC		0,5
Cota 335	01.86-12.91	1	0 241 229 715	W 8 DC		0,5
350 cc						
Cota 349	01.80-12.85	1	0 241 229 715	W 8 DC		0,5
Cota 350	01.83-12.88	1	0 241 229 715	W 8 DC		0,5
MH 349	01.82-12.86	1	0 242 229 656	WR 8 DC+		0,6
410 cc						
Cappra 414	01.81-12.86	1	0 241 248 538	W 4 CC		0,5



Typ



MOTO GUZZI

125 cc						
125 C	01.84-12.94		1	0 242 255 502	WR 3 CC	0,5
			1	0 242 255 504	WR 3 CS	0,5
350 cc						
V 35 C	01.82-12.87		2	0 242 245 552	WR 5 DC+	0,6
V 35 II	12.80-01.87		2	0 241 245 581	W 5 CC	0,5
V 35 Imola	11.79-01.87		2	0 241 245 581	W 5 CC	0,5
V 35 Nevada	01.92→		2	0 241 248 538	W 4 CC	0,6
V 35 Polizia NT	05.91-12.01		2	0 242 245 552	WR 5 DC+	0,6
V 35 TT	06.84-12.87		2	0 242 245 552	WR 5 DC+	0,5
350 Trentacinque GT	05.87-12.91		2	0 242 245 552	WR 5 DC+	0,6
500 cc						
V 50 C	01.82-12.87		2	0 242 245 552	WR 5 DC+	0,6
650 cc						
V 65 California	01.85-12.87		2	0 242 245 552	WR 5 DC+	0,6
V 65 Florida	02.86-12.91		2	0 241 248 538	W 4 CC	0,6
V 65 II	01.85-12.95		2	0 242 245 552	WR 5 DC+	0,6
V 65 NTX	01.90-12.96		2	0 241 248 538	W 4 CC	0,6
V 65 Sessantacinque	01.88-12.98		2	0 242 245 552	WR 5 DC+	0,6
750 cc						
Breva 750	01.03→		2	0 242 250 503	WR 4 CC	0,6
Breva 750 Touring	01.06→		2	0 242 250 503	WR 4 CC	0,6
Nevada Classic 750 i.e.	01.04→		2	0 242 250 503	WR 4 CC	0,6
V 7 Classic	01.08→		2	0 242 250 503	WR 4 CC	0,6
V 75 SP	09.90-12.00		2	0 242 250 503	WR 4 CC	0,6
			2	0 242 255 504	WR 3 CS	0,6
750 Nevada	02.91-12.01		2	0 241 248 538	W 4 CC	0,6
750 NTX	01.91-12.94		2	0 241 248 538	W 4 CC	0,6
750 NTX Polizia	07.88-12.98		2	0 241 248 538	W 4 CC	0,6
750 PA	05.91-12.01		2	0 242 250 503	WR 4 CC	0,6
			2	0 242 255 504	WR 3 CS	0,6
750 S 3	01.77-12.78		2	0 241 245 581	W 5 CC	0,5
750 SP	01.91-12.94		2	0 241 248 538	W 4 CC	0,6
750 Targa	07.88-12.94		2	0 241 248 538	W 4 CC	0,6
850 cc						
Breva 850	01.06→	DOV	2	0 242 235 663	WR 7 DC+	0,8
Griso 850	01.07→	DOV	2	0 242 235 663	WR 7 DC+	0,8
Norge 850	01.07→	DOV	2	0 242 235 663	WR 7 DC+	0,8
V 85	06.84-12.85		2	0 242 229 656	WR 8 DC+	0,6
V 85 TS Polizia	03.90-12.00		2	0 242 229 656	WR 8 DC+	0,6
850 Le Mans	01.75-12.77		2	0 242 245 552	WR 5 DC+	0,6
850 T 3	01.75-12.84		2	0 241 245 581	W 5 CC	0,6
850 T 3 California	07.79-12.81		2	0 242 235 663	WR 7 DC+	0,5
950 cc						
Bellagio 950	01.07→	DOV	2	0 242 235 663	WR 7 DC+	0,6
V 1000 California II	01.82-07.88		2	0 242 235 663	WR 7 DC+	0,6
V 1000 California III, C	02.91-07.93		2	0 242 235 663	WR 7 DC+	0,7
V 1000 GS	11.77-12.84		2	0 241 245 581	W 5 CC	0,6
V 1000 I Convert	01.75-12.83		2	0 241 245 581	W 5 CC	0,6
V 1000 Le Mans III	01.83-12.84		2	0 242 245 552	WR 5 DC+	0,6
V 1000 SP II	01.85-12.95		2	0 242 235 663	WR 7 DC+	0,7
1000 CI	01.88-12.89		2	0 242 245 552	WR 5 DC+	0,6



1000 CX Le Mans	01.78-12.81		2	0 241 245 581	W 5 CC	0,7
1000 Le Mans	03.85-12.94		2	0 242 245 552	WR 5 DC+	0,6
1000 SP	11.77-06.84		2	0 241 245 581	W 5 CC	0,6
1000 SP II	06.84-12.88		2	0 242 235 663	WR 7 DC+	0,6
1000 cc						
V 10 Centauro	03.96-12.00		2	0 242 160 503	XR 2 CE 0	0,7
1000 Daytona RS	01.97-12.00		2	0 242 160 503	XR 2 CE 0	
1100 cc						
California	01.94→		2	0 242 235 663	WR 7 DC+	0,6
Daytona 1100 RS	01.96→		2	0 242 150 507	XR 4 CC	0,7
Quota 1100 KM	06.98→	DOV	2	0 242 235 663	WR 7 DC+	0,6
Sport 1100i	01.96→		2	0 242 235 663	WR 7 DC+	0,6
Stone 1100 Touring	01.03→	DOV	2	0 242 235 663	WR 7 DC+	0,6
V 11 Cafe Sport	01.04→		2	0 242 235 663	WR 7 DC+	0,6
V 11 Le Mans	01.02→		2	0 242 235 663	WR 7 DC+	0,6
V 11 Le Mans Nero Corsa	01.03→		2	0 242 235 663	WR 7 DC+	0,6
V 11 Le Mans Rosso Corsa	01.03→		2	0 242 235 663	WR 7 DC+	0,6
V 11 Rosso Mandello	01.01→		2	0 242 235 663	WR 7 DC+	0,6
V 11 Scura	01.99→		2	0 242 235 663	WR 7 DC+	0,6
V 11 Sport	01.01→		2	0 242 235 663	WR 7 DC+	0,6
V 11 Sport Ballabio	01.04→		2	0 242 235 663	WR 7 DC+	0,6
1100 Sport	10.94-12.00		2	0 242 235 663	WR 7 DC+	0,6
	01.95→	DOV	2	0 242 235 663	WR 7 DC+	0,6
1150 cc						
GT 1150	01.06→	DOV	2	0 242 235 663	WR 7 DC+	0,6
Norge 1200	01.06→	DOV	2	0 242 235 663	WR 7 DC+	0,6
1200 Sport	01.07→	DOV	2	0 242 235 663	WR 7 DC+	0,6

MOTO MORINI

250 cc						
250	01.79-12.81		1	0 242 245 552	WR 5 DC+	0,6
500 cc						
500 T/S	01.77-12.83		2	0 242 245 552	WR 5 DC+	0,6
1200 cc						
Corsaro 1200	01.05→		2	0 242 068 500	UR 08 CC	0,7

MOTOBECANE

80 cc						
Enduro	01.82-07.83		1	0 241 256 522	W 3 CC	0,4

MOTO-SPEZIAL

1100 cc						
Bassa Lunga 1100	01.99→		2	0 241 235 755	W 7 DC	0,8
Sportiva 1100i	01.99→		2	0 241 235 755	W 7 DC	0,8



Typ



MV AGUSTA

125 cc					
125 Sport	01.76-12.78	1	0 241 256 512	W 3 AC	0,5
350 cc					
350 Sport	01.76-12.80	2	0 241 248 538	W 4 CC	0,5
800 cc					
800 S	06.75-06.80	4	0 241 248 538	W 4 CC	0,5
900 cc					
900 S	02.77-06.80	4	0 241 248 538	W 4 CC	0,5
910 cc					
910 Brutale R/S	01.06→	4	0 242 068 500	UR 08 CC	0,7
990 cc					
Brutale 990 R	01.08→	4	0 242 068 500	UR 08 CC	0,7
1100 cc					
F4 1078 RR	01.09→	4	0 242 068 500	UR 08 CC	0,7

MZ (MOTORRADWERKE ZSCHOPAU)

70 cc					
S 70	01.83-12.88	1	0 241 245 580	W 5 AC	
125 cc					
ETZ 125 Saxon Roadstar	01.93-12.98	1	0 241 256 512	W 3 AC	0,6
ETZ 125 Saxon Sportstar	01.93-12.98	1	0 241 256 512	W 3 AC	0,6
ETZ 125 Saxon Standard	01.91-12.98	1	0 241 256 512	W 3 AC	0,6
Gangsta 125	01.05→	1	0 242 065 500	UR 09 CC	0,6
RT 125	01.00→	1	0 242 065 500	UR 09 CC	0,6
Supermoto 125	01.05→	1	0 242 065 500	UR 09 CC	0,6
TS 125	01.75-12.85	1	0 241 256 512	W 3 AC	0,6
125 SX/SM	01.01-12.08	1	0 242 065 500	UR 09 CC	0,6
150 cc					
ETZ 150	01.84-12.90	1	0 241 256 512	W 3 AC	0,6
Saxon Sportstar 150	01.93-12.98	1	0 241 256 512	W 3 AC	0,6
TS 150	01.75-12.85	1	0 241 256 512	W 3 AC	0,6
250 cc					
ETZ 250	09.81-12.90	1	0 241 256 512	W 3 AC	0,6
ETZ 251	01.87-12.90	1	0 241 256 512	W 3 AC	0,5
ETZ 251 Gespann	01.91-12.97	1	0 241 256 512	W 3 AC	
ETZ 251 Saxon Fun	01.91-12.97	1	0 241 256 512	W 3 AC	0,6
ETZ 251 Saxon Tour	01.91-12.97	1	0 241 256 512	W 3 AC	0,6
TS 250	01.75-12.85	1	0 241 256 512	W 3 AC	0,6
300 cc					
ETZ 301 Saxon Fun	08.90-12.98	1	0 241 256 512	W 3 AC	0,6
ETZ 301 Saxon Tour	08.90-12.98	1	0 241 256 512	W 3 AC	0,6
500 cc					
ETZ 500 Saxon Country	01.93-12.98	1	0 241 150 504	X 4 CC	0,7
ETZ 500 Saxon Fun	01.93-12.98	1	0 241 150 504	X 4 CC	0,7
ETZ 500 Saxon Tour	01.91-12.98	1	0 241 150 504	X 4 CC	0,7
ETZ 500 Saxon Voyager	01.93-12.98	1	0 241 150 504	X 4 CC	0,7
Silver Star Classic	01.93-12.98	1	0 241 150 504	X 4 CC	0,7
Silver Star Gespann	01.95-12.98	1	0 241 150 504	X 4 CC	0,7
660 cc					
660 Baghira Black Panther	05.97→	1	0 242 150 505	XR 4 DC	0,9



660 Baghira Enduro	05.97→	1	0 242 150 505	XR 4 DC	0,9
660 Baghira Forest	05.97→	1	0 242 150 505	XR 4 DC	0,9
660 Baghira Streetmoto	05.97→	1	0 242 150 505	XR 4 DC	0,9
660 Baghira Trail	01.98→	1	0 242 150 505	XR 4 DC	
660 Mastiff	05.97→	1	0 242 150 505	XR 4 DC	0,9
660 Skorpion Cup	01.94-12.05	1	0 242 150 505	XR 4 DC	0,9
660 Skorpion Gespann	01.94-12.05	1	0 242 150 505	XR 4 DC	
660 Skorpion Replica	01.94-12.05	1	0 242 150 505	XR 4 DC	0,9
660 Skorpion Sport	01.94-12.05	1	0 242 150 505	XR 4 DC	0,9
660 Skorpion Sport Replica	01.94-12.05	1	0 242 150 505	XR 4 DC	
660 Skorpion Tour	01.94-12.05	1	0 242 150 505	XR 4 DC	0,9
660 Skorpion Traveller	01.94-12.05	1	0 242 150 505	XR 4 DC	0,9
660 Supermoto	01.05→	1	0 242 150 505	XR 4 DC	0,9

NORTON

650 cc					
C 652 SM	01.98-12.01	1	0 241 150 504	X 4 CC	0,6

OSCAR

80 cc					
XR Enduro	01.82-12.92	1	0 241 235 755	W 7 DC	0,8

OSSA

175 cc					
Super Pioneer 175	01.76-12.78	1	0 241 248 538	W 4 CC	0,5
250 cc					
Copa 250	01.79-12.81	1	0 241 256 522	W 3 CC	0,5
Desert 250	01.79-12.81	1	0 241 256 522	W 3 CC	0,5
F3 250	01.81-12.82	1	0 241 256 522	W 3 CC	0,5
Super Pioneer 250	01.76-12.78	1	0 241 256 522	W 3 CC	0,5
T 250	01.76-12.77	1	0 241 256 522	W 3 CC	0,5
TE 250	01.80-12.83	1	0 241 256 522	W 3 CC	0,5
TR 80 250	01.79-12.81	1	0 241 229 715	W 8 DC	0,5
Tu-Yo 250	01.81-12.83	1	0 241 229 715	W 8 DC	0,5
Urbe 250	01.82-12.83	1	0 241 256 522	W 3 CC	0,5
350 cc					
Desert 350	01.79-12.81	1	0 241 248 538	W 4 CC	0,5
Super Pioneer 350	01.79-12.81	1	0 241 248 538	W 4 CC	0,5
TR 80 350	01.79-12.81	1	0 241 229 715	W 8 DC	0,5
Tu-Yo 350	01.81-12.83	1	0 241 229 715	W 8 DC	0,5
303 Trial 350	01.82-12.83	1	0 241 229 715	W 8 DC	0,5
500 cc					
Yankee 500	01.75-12.76	1	0 241 248 538	W 4 CC	0,5



Typ

**PEUGEOT****80 cc**

SX 8 T	02.78-12.82		1	0 241 245 580	W 5 AC	0,5
TLX 80	01.79-12.89		1	0 241 235 607	W 7 AC	0,5
125 cc						
TLX 125	01.79-12.89		1	0 241 235 607	W 7 AC	0,5
XPS CT 125	01.06→		1	0 242 065 501	UR 09 AC	

PGO**80 cc**

Star 80	01.93-12.05		1	0 241 235 754	W 7 BC	0,6
100 cc						
T-Rex 110	01.99-12.05		1	0 241 245 656	W 5 BC	

PUCH (STEYR-DAIMLER-PUCH AG)**80 cc**

Cobra 80	01.81-12.87	XJB	1	0 241 260 507	W 2 AC	0,5
		XJC	1	0 241 256 522	W 3 CC	0,5

125 cc

MC 125	01.75→		1	0 241 256 522	W 3 CC	0,5
--------	--------	--	---	---------------	--------	-----

250 cc

GS 250 F3 Rotax	12.80-12.90		1	0 241 248 538	W 4 CC	0,5
GS 250 F5	01.85-12.95		1	0 241 248 538	W 4 CC	0,5
GS 250 HF	01.86-12.96		1	0 241 248 538	W 4 CC	0,5
MC 250	12.80-12.90		1	0 241 256 522	W 3 CC	0,5
350 cc						
GS 350	01.85-12.95		1	0 241 274 505	W 07 CS	0,6
370 cc						
GS 366	12.80-12.90		1	0 241 248 538	W 4 CC	0,5

REGENT**125 cc**

Roadster 125	01.95-12.98		1	0 241 245 580	W 5 AC	0,6
Roadster 125 Deluxe	01.95-12.98		1	0 241 245 580	W 5 AC	0,6
RT 125	01.95-12.98		1	0 241 245 580	W 5 AC	0,6

150 cc

Roadster 150	01.95-12.98		1	0 241 245 580	W 5 AC	0,6
Roadster 150 Deluxe	01.95-12.98		1	0 241 245 580	W 5 AC	0,6
RT 150	01.95-12.98		1	0 241 245 580	W 5 AC	0,6

175 cc

Roadster 175	01.95-12.98		1	0 241 245 580	W 5 AC	0,6
Roadster 175 Deluxe	01.95-12.98		1	0 241 245 580	W 5 AC	0,6
RT 175	01.95-12.98		1	0 241 245 580	W 5 AC	0,6



Typ



REX

125 cc

Chopper 125	01.98→	1	0 242 150 507	XR 4 CC	0,7
Cruiser 125	01.99→	1	0 242 150 507	XR 4 CC	0,7
Rexy 125	01.97→	1	0 242 065 501	UR 09 AC	0,5

RIEJU

75 cc

TT 406	01.78→	1	0 241 235 607	W 7 AC	0,5
--------	--------	---	---------------	--------	-----

125 cc

MRX 125	01.02→	1	0 242 065 501	UR 09 AC	0,6
		1	0 242 250 503	WR 4 CC	0,8
SMX 125	01.02→	1	0 242 065 501	UR 09 AC	0,6
	01.03→	1	0 242 250 503	WR 4 CC	0,8

ROYAL ENFIELD

350 cc

India 350	01.77-12.87	1	0 241 245 580	W 5 AC	0,5
-----------	-------------	---	---------------	--------	-----

500 cc

Bullet Electra 500	01.05-12.07	1	0 241 256 522	W 3 CC	0,5
Bullet Sixty-5 500	01.04-12.06	1	0 242 250 503	WR 4 CC	0,7
Bullet 500	01.91-12.07	1	0 242 250 503	WR 4 CC	0,7
India 500	01.77-12.87	1	0 241 248 538	W 4 CC	0,5

SACHS (FICHTEL & SACHS AG)

80 cc

RX 9 80	01.82-12.85	1	0 241 256 512	W 3 AC	0,5
Ultra 80 AC	01.82-12.83	1	0 241 245 580	W 5 AC	0,5
Ultra 80 LC	01.81-12.83	1	0 241 256 512	W 3 AC	0,5
XE 9 80	01.82-12.93	1	0 241 256 512	W 3 AC	0,5

110 cc

Dirty Devil 110	01.05→	1	0 241 056 502	U 3 AC	0,6
-----------------	--------	---	---------------	--------	-----

125 cc

MadAss 125	01.05→	2	0 242 065 501	UR 09 AC	0,8
Roadster 125 V2	01.98-12.05	2	0 242 055 501	UR 3 AC	0,8
RS 125	01.97-12.04	1	0 242 250 503	WR 4 CC	0,7
X-Road 125	01.04→	1	0 242 065 500	UR 09 CC	0,6
XT.C 125 2T	01.98-12.02	1	0 242 255 502	WR 3 CC	0,8
XTC-N 125	01.98-12.01	1	0 242 250 503	WR 4 CC	0,8
ZX 125	01.97→	1	0 242 250 503	WR 4 CC	0,7
	05.97-12.08	1	0 242 255 502	WR 3 CC	0,6
ZZ 125	01.97→	1	0 242 250 503	WR 4 CC	0,8
	01.98→	1	0 242 255 502	WR 3 CC	0,8

650 cc

Roadster 650	01.99→	1	0 242 068 500	UR 08 CC	0,8
--------------	--------	---	---------------	----------	-----



Typ

**SANGLAS**

400 cc					
400 E	01.76-12.78	1	0 241 235 755	W 7 DC	0,5
400 F	01.78-12.81	1	0 242 235 663	WR 7 DC+	0,6
500 cc					
500	12.77-12.87	1	0 241 235 755	W 7 DC	0,5

SCORPA

250 cc					
Easy Trial 250	01.94-01.00	1	0 241 229 715	W 8 DC	0,7
280 cc					
Easy Trial 280	01.94-01.00	1	0 241 229 715	W 8 DC	0,7

SHERCO

80 cc					
Trial 0.8	01.08→	1	0 241 229 715	W 8 DC	0,7
125 cc					
CityCorp 125 Enduro	01.03-12.07	1	0 242 065 501	UR 09 AC	0,5
	01.08→	1	0 242 055 501	UR 3 AC	0,5
CityCorp 125 Supermotard	01.03-12.07	1	0 242 065 501	UR 09 AC	0,5
	01.08→	1	0 242 055 501	UR 3 AC	0,5
Trial 1.25	01.00→	1	0 241 229 715	W 8 DC	0,6
200 cc					
Trial 2.0	01.01→	1	0 241 229 715	W 8 DC	0,6
250 cc					
Trial 2.5	01.00→	1	0 241 229 715	W 8 DC	0,6
290 cc					
Trial 2.9	01.00→	1	0 241 229 715	W 8 DC	0,5
450 cc					
Enduro 4.5i	01.05→	1	0 242 060 505	UR 2 CDC	0,6
Supermotard 4.5i	01.05→	1	0 242 060 505	UR 2 CDC	0,6
510 cc					
Enduro 5.1i	01.08→	1	0 242 060 505	UR 2 CDC	0,6
Supermotard 5.1i	01.08→	1	0 242 060 505	UR 2 CDC	0,6

SIMSON

70 cc					
GS 75 1	01.75-12.90	1	0 241 256 512	W 3 AC	0,6
Habicht 80	01.96-12.02	1	0 241 256 512	W 3 AC	0,4
Habicht 80 Basic	01.96-12.02	1	0 241 256 512	W 3 AC	0,4
S 70	01.80-12.90	1	0 241 256 512	W 3 AC	0,4
S 80	01.96-12.98	1	0 241 256 512	W 3 AC	0,6
S 83 B	01.93-12.95	1	0 241 256 512	W 3 AC	0,6
S 83 CX	01.93-12.94	1	0 241 256 512	W 3 AC	0,6
S 83 OR	01.93-12.94	1	0 241 256 512	W 3 AC	0,6



Typ



S 83-80 alpha B	01.95-12.02	1	0 241 256 512	W 3 AC	0,6
S 83-80 alpha C	01.95-12.02	1	0 241 256 512	W 3 AC	0,6
Sperber 80	01.96-12.02	1	0 241 256 512	W 3 AC	0,4

STEYR (STEYR-DAIMLER-PUCH AG)

80 cc					
Cobra 80 GT	01.82-12.87	1	0 241 256 522	W 3 CC	0,5
Cobra 80 6	01.81-12.81	1	0 241 260 507	W 2 AC	0,5
250 cc					
GS 250 F3	12.80-12.90	1	0 241 256 515	W 3 CS	0,5
		1	0 242 255 502	WR 3 CC	0,5
MC 250 U.H.S	12.80-12.90	1	0 241 256 515	W 3 CS	0,5
		1	0 242 255 502	WR 3 CC	0,5
370 cc					
GS 366 F3	12.80-12.90	1	0 241 256 515	W 3 CS	0,5
		1	0 242 255 502	WR 3 CC	0,5
470 cc					
MC 500 U.H.S	12.80-12.90	1	0 241 274 505	W 07 CS	0,6

SUNDIRO

125 cc					
Phoenix XDZ 125TN	01.96→	1	0 242 150 507	XR 4 CC	0,6

SUZUKI

65 cc					
RM 65	01.04-12.09	1	0 242 274 501	WR 07 CS	0,6
80 cc					
FR 80	01.95-12.02	1	0 242 235 665	WR 7 BC+	0,7
GT 80 EL	01.82-12.92	1	0 241 248 538	W 4 CC	0,7
JR 80	01.02→	1	0 242 245 521	WR 5 CC	0,8
RG 80 WF	01.85-12.91	1	0 242 245 552	WR 5 DC+	0,8
RM 80 H	01.83→	1	0 242 255 502	WR 3 CC	0,8
RM 80 X	01.83-12.90	1	0 242 255 502	WR 3 CC	0,8
	01.91→	1	0 242 265 500	WR 09 CC	0,7
85 cc					
RM 85	01.02→	1	0 242 265 500	WR 09 CC	0,8
100 cc					
A 100	01.95→	1	0 241 235 754	W 7 BC	0,6
FB 100	01.91→	1	0 241 150 504	X 4 CC	0,6
GP 100	01.83-12.93	1	0 241 256 512	W 3 AC	0,7
110 cc					
DR-Z 110	01.02-12.09	1	0 242 055 501	UR 3 AC	0,7
125 cc					
DR 125 S	01.87-12.94	1	0 242 150 507	XR 4 CC	0,7
DR 125 SE	01.95-12.02	1	0 242 150 507	XR 4 CC	0,6
DR 125 SM	01.09→	1	0 242 065 500	UR 09 CC	
DR-Z 125	01.08-12.12	1	0 242 150 507	XR 4 CC	
GN 125	01.89-12.01	1	0 242 150 507	XR 4 CC	0,7
GP 125	01.79-12.89	1	0 241 256 512	W 3 AC	0,7



Typ



◀ SUZUKI

GS 125	01.91-12.05		1	0 242 150 507	XR 4 CC	0,9
GT 125	01.75-12.89		2	0 241 256 512	W 3 AC	0,7
GZ 125 Marauder	01.99-12.03		1	0 242 150 507	XR 4 CC	0,7
	01.04-12.05		1	0 242 065 500	UR 09 CC	
	01.08-12.11		1	0 242 065 500	UR 09 CC	
RG 125	01.85-12.96		1	0 242 255 502	WR 3 CC	0,7
RV 125 Van Van	01.03-12.06		1	0 242 065 500	UR 09 CC	0,6
TS 125	01.76-12.77		1	0 241 256 512	W 3 AC	0,5
	01.78-12.78		1	0 242 250 503	WR 4 CC	0,8
TS 125 ER	01.80-12.83		1	0 241 248 538	W 4 CC	0,8
TS 125 R	01.89-12.96		1	0 242 255 502	WR 3 CC	0,8
TU 125 XT	01.99→		1	0 242 150 507	XR 4 CC	0,7
VL 125 Intruder 125 ccm	01.00-12.07		2	0 242 065 500	UR 09 CC	0,6
RV 125 Van Van 200 cc	01.07→		1	0 242 065 500	UR 09 CC	0,6
DR 200 SZ	01.95→		1	0 242 150 507	XR 4 CC	0,6
GT 200	01.80→		2	0 241 248 538	W 4 CC	0,8
TS 200 R 250 cc	01.91-12.93		1	0 242 255 502	WR 3 CC	0,8
DR 250	01.90→		1	0 242 150 505	XR 4 DC	0,9
DR 250 S / SZ-H	01.82-12.89		1	0 242 150 507	XR 4 CC	0,7
GN 250	01.86-11.99		1	0 242 150 507	XR 4 CC	0,7
GNX 250 E	01.82-12.84		1	0 242 150 507	XR 4 CC	0,7
GSX 250 E	01.81-12.83		2	0 242 160 503	XR 2 CE 0	0,7
GW 250 Inazuma	01.12→		2	0 242 060 501	UR 2 CC	0,7
GZ 250 Marauder	01.99-12.07	STT	1	0 242 150 507	XR 4 CC	0,7
RG 250	01.83-12.89		2	0 242 255 502	WR 3 CC	0,7
RGV 250	01.89-12.90		2	0 242 255 502	WR 3 CC	0,8
RM 250	01.01→		1	0 242 255 504	WR 3 CS	0,6
RM-Z 250	01.04-12.06		1	0 242 065 500	UR 09 CC	0,6
TS 250 X	01.86-12.89		1	0 242 255 502	WR 3 CC	0,8
TU 250 X	01.97-12.01		1	0 242 150 507	XR 4 CC	
VL 250 Intruder 350 cc	01.00-12.07		2	0 242 060 501	UR 2 CC	
DR 350	01.90→		1	0 242 074 500	UR 07 CDC	0,6
DR 350 P	01.93-12.98		1	0 242 150 505	XR 4 DC	0,9
DR 350 S	01.90-12.94		1	0 242 150 505	XR 4 DC	0,9
DR 350 SH	01.92-12.94		1	0 242 150 505	XR 4 DC	0,9
DR 350 SZ	01.95-12.99		1	0 242 074 500	UR 07 CDC	0,6
Goose 350	01.92-12.02		1	0 242 074 500	UR 07 CDC	0,7
400 cc						
DR 400 S	01.80-12.83		1	0 242 150 507	XR 4 CC	0,7
DR-Z 400	01.99-12.09		1	0 242 065 500	UR 09 CC	0,6
GN 400 TD	01.81-12.87		2	0 242 150 507	XR 4 CC	0,7
GS 400 EC	01.77-12.82		2	0 241 248 538	W 4 CC	0,7
GS 400 T	01.81-12.87		2	0 241 248 538	W 4 CC	0,7
GSF 400 Bandit	01.88-12.91		4	0 242 060 505	UR 2 CDC	0,7
	01.92-12.95		4	0 242 074 500	UR 07 CDC	0,7
GSX 400 E	01.83-12.88		2	0 242 150 507	XR 4 CC	0,7
GSX 400 FX	01.82-12.84		4	0 242 150 507	XR 4 CC	0,6
GSX 400 LX	01.82-12.83		2	0 242 150 507	XR 4 CC	0,7
GSX 400 S	01.80-12.90		2	0 242 150 507	XR 4 CC	0,6
GSX-R 400	01.84-12.92		4	0 242 060 505	UR 2 CDC	0,7
	01.93-12.99		4	0 242 074 500	UR 07 CDC	0,7



Typ



450 cc						
GS 450 ES	01.85-12.89	2	0 241 248 538	W 4 CC	0,7	
GS 450 SF	01.80-12.89	2	0 242 250 503	WR 4 CC	0,7	
GS 450 TL	01.81-12.91	2	0 241 248 538	W 4 CC	0,7	
500 cc						
DR 500 S	01.81-12.83	1	0 241 150 504	X 4 CC	0,7	
		1	0 242 150 507	XR 4 CC	0,7	
GT 500	01.76-12.80	2	0 242 245 517	WR 5 AC	0,5	
RG 500 Gamma	01.85-12.89	4	0 242 255 502	WR 3 CC	0,8	
RGV 500	01.89-12.00	4	0 242 255 502	WR 3 CC	0,8	
550 cc						
GS 550 E	01.77-12.87	4	0 241 248 538	W 4 CC	0,7	
GS 550 M	01.81-12.83	4	0 241 248 538	W 4 CC	0,7	
GSX 550 E	01.85-12.87	4	0 242 160 503	XR 2 CE 0	0,7	
600 cc						
DR 600 R DAKAR	01.86-12.89	1	0 242 150 505	XR 4 DC	0,9	
DR 600 S	01.85-12.89	1	0 242 150 505	XR 4 DC	0,9	
GSF 600 Bandit	01.95-12.04	4	0 242 074 500	UR 07 CDC	0,7	
GSR 600	01.06-12.11	4	0 242 068 500	UR 08 CC	0,7	
GSX 600 F	01.98-12.06	4	0 242 074 500	UR 07 CDC	0,7	
GSX-R 600	01.92-12.07	4	0 242 068 500	UR 08 CC	0,7	
RF 600 R	01.93-12.97	4	0 242 068 500	UR 08 CC	0,7	
650 cc						
DL 650 V-Strom	01.04-12.11	2	0 242 065 500	UR 09 CC	0,8	
DR 650 R	01.90-12.94	1	0 242 150 505	XR 4 DC	0,9	
DR 650 RE	01.94-12.94	1	0 242 150 505	XR 4 DC	0,9	
DR 650 RS	01.90-12.91	1	0 242 150 505	XR 4 DC	0,9	
DR 650 RSE	01.90-12.91	1	0 242 150 505	XR 4 DC	0,9	
DR 650 SE	01.95-12.99	1	0 242 068 500	UR 08 CC	0,6	
GR 650	01.83-12.89	2	0 242 150 507	XR 4 CC	0,6	
GS 650 G	01.81-12.82	4	0 242 150 507	XR 4 CC	0,6	
GSF 650 Bandit	01.05-12.06	4	0 242 060 505	UR 2 CDC	0,6	
	01.07-12.07	4	0 242 068 500	UR 08 CC	0,7	
	01.08→	4	0 242 065 500	UR 09 CC		
GSX 650 F	01.08→	4	0 242 065 500	UR 09 CC	0,6	
SFV 650 Gladius	01.09→	2	0 242 055 508	UHR 3 CC		
SV 650	01.99-12.10	2	0 242 065 500	UR 09 CC	0,7	
XF 650 Freewind	01.97-12.01	1	0 242 080 500	UR 06 CDC	0,7	
XN 85 Turbo	01.82-12.87	4	0 241 150 504	X 4 CC	0,7	
750 cc						
DR 750 S Big Touring	01.88-12.89	1	0 242 150 505	XR 4 DC	0,9	
GS 750	01.76-12.80	4	0 241 248 538	W 4 CC	0,7	
GS 750 E	01.78-12.84	4	0 241 248 538	W 4 CC	0,7	
GSX 750	01.98-12.01	4	0 242 074 500	UR 07 CDC	0,7	
GSX 750 E	01.80-12.87	4	0 241 150 504	X 4 CC	0,7	
		4	0 242 150 507	XR 4 CC	0,6	
GSX 750 EF	01.84-12.86	4	0 242 150 507	XR 4 CC	0,7	
GSX 750 ES	01.83-12.86	4	0 241 150 504	X 4 CC	0,7	
GSX 750 F	01.98-12.06	4	0 242 074 500	UR 07 CDC		STT
GSX 750 S	01.85-12.85	4	0 242 150 507	XR 4 CC	0,6	
GSX 750 S Katana	01.81-12.84	4	0 242 150 507	XR 4 CC	0,7	
GSX-R 750	01.90-12.98	4	0 242 080 500	UR 06 CDC	0,7	
	01.98-12.07	4	0 242 068 500	UR 08 CC	0,7	
GSX-R 750 / Spezial Edition	01.86-12.87	4	0 242 160 503	XR 2 CE 0	0,7	
GSX-R 750 J - K	01.88-12.89	4	0 242 160 503	XR 2 CE 0	0,7	



◀ SUZUKI

GSX-R 750 R	01.89-12.89		4	0 242 080 500	UR 06 CDC	0,7
GSX-R 750 RG	01.85-12.88		4	0 242 160 503	XR 2 CE 0	0,7
GSX-R 750 W	01.92-12.95		4	0 242 074 500	UR 07 CDC	0,7
	01.94-12.97		4	0 242 068 500	UR 08 CC	
VS 750 Intruder	01.85-12.91		2	0 242 150 505	XR 4 DC	0,9
800 cc						
DR Big SU 800	01.91-12.99		1	0 242 150 505	XR 4 DC	0,9
DR 800 S	01.90-12.99		1	0 242 150 505	XR 4 DC	0,9
DR 800 SU	01.90-12.99		1	0 242 150 505	XR 4 DC	0,9
850 cc						
GS 850 G	01.79-12.88		4	0 241 248 538	W 4 CC	0,7
GS 850 GL	01.79-12.88		4	0 241 248 538	W 4 CC	0,7
900 cc						
RF 900 R	09.93-12.99		4	0 242 068 500	UR 08 CC	0,7
RF 900 RS 2	09.93-12.99		4	0 242 068 500	UR 08 CC	
1000 cc						
DL 1000 V-Strom	01.02-12.10		2	0 242 060 505	UR 2 CDC	0,7
GS 1000	01.78-12.82		4	0 241 248 538	W 4 CC	0,7
GSX-R 1000	01.01-12.06		4	0 242 068 500	UR 08 CC	0,7
SV 1000/S	01.03-12.07		2	0 242 060 505	UR 2 CDC	0,7
TL 1000 R	01.98-12.00		2	0 242 074 500	UR 07 CDC	0,7
TL 1000 S	01.97-12.97		2	0 242 065 500	UR 09 CC	0,7
	01.98-12.01		2	0 242 060 505	UR 2 CDC	
1100 cc						
GS 1100 E	01.80-12.83		4	0 242 150 507	XR 4 CC	0,6
GS 1100 G	01.82→		4	0 241 248 538	W 4 CC	0,8
GSX 1100 E	01.80-12.81		4	0 241 150 504	X 4 CC	0,7
	01.82-12.83		4	0 242 150 507	XR 4 CC	0,6
	01.84-12.87		4	0 242 160 503	XR 2 CE 0	0,7
GSX 1100 F	01.88-12.96		4	0 242 160 503	XR 2 CE 0	0,7
GSX 1100 G	01.91-12.96		4	0 242 160 503	XR 2 CE 0	0,7
GSX 1100 S	01.82-12.84		4	0 241 150 504	X 4 CC	0,7
GSX-R 1100	01.86-12.92		4	0 242 160 503	XR 2 CE 0	0,7
	01.93-12.97		4	0 242 068 500	UR 08 CC	0,7
1150 cc						
GSX 1150 E	01.80-12.85		4	0 242 160 503	XR 2 CE 0	0,7
	01.86→		4	0 242 150 505	XR 4 DC	0,9
GSX 1150 EF	01.80-02.87		4	0 242 160 503	XR 2 CE 0	0,7
GSX 1150 ES	01.80→		4	0 242 160 503	XR 2 CE 0	0,7
1200 cc						
GSF 1200/S Bandit	01.95-12.06	STT	4	0 242 160 503	XR 2 CE 0	0,7
GV 1200 Madura	01.86-12.96		4	0 242 150 507	XR 4 CC	0,7
1250 cc						
GSF Bandit 1250	01.07→		4	0 242 060 501	UR 2 CC	0,6
GSX 1250	01.10→		4	0 242 060 501	UR 2 CC	
1300 cc						
GSX 1300 R Hayabusa	01.99-12.07		4	0 242 068 500	UR 08 CC	0,7
1400 cc						
GSX 1400	01.02-12.07		4	0 242 060 505	UR 2 CDC	0,7
1800 cc						
VLR Intruder C1800	01.08→		2	0 242 060 505	UR 2 CDC	0,7
VZR Intruder M1800	01.06→		2	0 242 060 505	UR 2 CDC	0,7



Typ



SWM

125 cc						
RS 125 TL	01.77-12.80		1	0 242 229 656	WR 8 DC+	0,7
RZ 125	04.82-12.92		1	0 241 256 515	W 3 CS	0,4
			1	0 241 256 522	W 3 CC	0,4
TL 125 MW	01.80-12.90		1	0 241 229 715	W 8 DC	0,4
TL 125 NW	01.80-12.90		1	0 242 229 656	WR 8 DC+	0,6
240 cc						
TL 240	01.80-12.90		1	0 241 229 715	W 8 DC	0,4
280 cc						
Guanaco 320 TLM	01.77-12.87		1	0 242 229 656	WR 8 DC+	0,6
RS 320 TL	01.78-11.79		1	0 242 235 663	WR 7 DC+	0,7
TL 320 MW	01.80-12.90		1	0 241 229 715	W 8 DC	0,4
TL 320 NW	04.80-12.90		1	0 242 229 656	WR 8 DC+	0,6
350 cc						
RS 347 GS TF3	01.82-12.92		1	0 241 274 505	W 07 CS	0,5
RS 347 MC TF3	01.79-12.80		1	0 241 274 505	W 07 CS	0,5
TL 350 Jumbo	01.82-12.90		1	0 241 229 715	W 8 DC	0,4
400 cc						
440 GS TF1	01.80-12.81		1	0 242 255 502	WR 3 CC	0,4
			1	0 242 255 504	WR 3 CS	0,4
440 GS TF3	01.82-12.92		1	0 242 255 502	WR 3 CC	0,4
			1	0 242 255 504	WR 3 CS	0,4
440 MC	01.80-12.81		1	0 242 255 502	WR 3 CC	0,4
			1	0 242 255 504	WR 3 CS	0,4
440 MC TF6	01.82-12.92		1	0 242 255 502	WR 3 CC	0,4
			1	0 242 255 504	WR 3 CS	0,4



SYM

100 cc						
Jet 100	01.98→		1	0 242 255 515	WR 3 BC 0	0,6
125 cc						
Husky 125	01.97-12.05		1	0 242 150 507	XR 4 CC	0,7
Joyride 125	01.03→	XJB	1	0 242 065 501	UR 09 AC	0,6
		XJC	1	0 242 065 500	UR 09 CC	0,7
Megalo 125	01.03→		1	0 241 056 502	U 3 AC	0,7
Shark 125	01.99-12.05		1	0 241 056 502	U 3 AC	0,7
Super Duke 125	01.96→		1	0 241 056 502	U 3 AC	0,7
Wolf Legend 125	01.05→		1	0 242 150 507	XR 4 CC	0,7
150 cc						
Joyride 150	01.02→		1	0 242 065 500	UR 09 CC	
180 cc						
Joyride 180	01.02→		1	0 242 065 500	UR 09 CC	
200 cc						
Joyride 200	01.05→		1	0 242 065 500	UR 09 CC	0,7
Track Runner 200	01.06→		1	0 242 065 500	UR 09 CC	0,6



Typ



TESTI

125 cc

Corsa 125	01.75-12.81	1	0 241 248 538	W 4 CC	0,5
2000 Special	01.75-12.81	1	0 241 248 538	W 4 CC	0,5

TGB

125 cc

202T Palio 125	01.98→	1	0 241 056 502	U 3 AC	0,7
----------------	--------	---	---------------	--------	-----

TITAN

1600 cc

Coyote 1600	01.97-12.03	2	0 242 229 656	WR 8 DC+	0,7
Fat Bobber 1600	01.08→	2	0 242 229 687	WR 8 DCX+	1,1
Gecko 1600	01.97-12.03	2	0 242 229 656	WR 8 DC+	0,7
Roadrunner 1600	01.97-12.03	2	0 242 229 656	WR 8 DC+	0,7
Scorpion 1600	01.97-12.03	2	0 242 229 656	WR 8 DC+	0,7
Sidewinder 1600	01.97-12.03	2	0 242 229 656	WR 8 DC+	0,7

1750 cc

Sidewinder Custom Pro Street	01.08→	2	0 242 229 687	WR 8 DCX+	1,1
------------------------------	--------	---	---------------	-----------	-----

1850 cc

Costum Rubber Mount Chopper 1850	01.05-12.09	2	0 242 229 687	WR 8 DCX+	1,1
Costum Softail Chopper 1850	01.05-12.09	2	0 242 229 687	WR 8 DCX+	1,1
Radical Rigid 1850	01.05-12.09	2	0 242 229 687	WR 8 DCX+	1,1

2000 cc

Costum Rubber Mount Chopper 2000	01.05-12.09	2	0 242 135 515	YR 7 DC+	0,8
Costum Softail Chopper 2000	01.05-12.09	2	0 242 135 515	YR 7 DC+	0,8
Radical Rigid 2000	01.05-12.09	2	0 242 135 515	YR 7 DC+	0,8

TM

80 cc

80 EN	01.94-12.00	1	0 241 256 515	W 3 CS	0,6
80 MX	01.94-12.00	1	0 241 256 515	W 3 CS	0,6

125 cc

125 EN	01.94-12.00	1	0 241 274 505	W 07 CS	0,6
	01.03-12.09	1	0 242 255 504	WR 3 CS	0,6
125 MX	01.94-12.00	1	0 241 274 505	W 07 CS	0,6

250 cc

250 EN	01.94-12.00	1	0 241 256 515	W 3 CS	0,6
	01.03-12.09	1	0 242 255 504	WR 3 CS	0,5
250 EN-F	01.04-12.09	1	0 242 065 500	UR 09 CC	0,7
250 MX	01.94-12.00	1	0 241 256 515	W 3 CS	0,6

300 cc

300 EN	01.95-12.00	1	0 241 256 515	W 3 CS	0,6
	01.03-12.09	1	0 242 255 504	WR 3 CS	0,5
300 MX	01.95-12.00	1	0 241 256 515	W 3 CS	0,6

450 cc

450 EN-F	01.04-12.09	1	0 242 065 500	UR 09 CC	0,7
----------	-------------	---	---------------	----------	-----



Typ



TRIUMPH

600 cc						
Daytona 600	01.03-12.04	4	0 242 074 500	UR 07 CDC	0,7	
Speed Four 600	01.02→	4	0 242 074 500	UR 07 CDC	0,7	
Supersport	01.01→	4	0 242 074 500	UR 07 CDC	0,7	
TT 600	01.00-12.03	4	0 242 074 500	UR 07 CDC	0,7	
650 cc						
Daytona 650	01.05-12.06	4	0 242 074 500	UR 07 CDC	0,7	
675 cc						
Daytona 675	01.06→	3	0 242 074 500	UR 07 CDC	0,7	
Daytona 675 RR	01.06→	3	0 242 074 500	UR 07 CDC	0,7	
Speed Triple 675	01.07→	3	0 242 074 500	UR 07 CDC	0,7	
750 cc						
Tiger TR7V	01.85-12.95	2	0 241 248 538	W 4 CC	0,5	
885 cc						
Legend TT	01.99-12.02	3	0 242 150 505	XR 4 DC	0,9	
955 cc						
Daytona Centennial Edition	01.02→	3	0 242 074 500	UR 07 CDC	0,6	
Daytona 955i	01.02→	3	0 242 074 500	UR 07 CDC	0,6	
Speed Triple 955	01.02-12.03	3	0 242 074 500	UR 07 CDC	0,6	
Sprint 955 RS	01.02-12.04	3	0 242 074 500	UR 07 CDC	0,6	
Sprint 955 ST	01.02-12.04	3	0 242 074 500	UR 07 CDC	0,6	
1050 cc						
Speed Triple	01.05→	3	0 242 074 500	UR 07 CDC	0,6	
Sprint ST	01.05-12.10	3	0 242 074 500	UR 07 CDC	0,6	
Tiger 1050	01.07→	3	0 242 074 500	UR 07 CDC	0,6	
1200 cc						
Tiger 1200 Explorer	01.12→	3	0 242 060 505	UR 2 CDC		

URAL

650 cc						
M3-8.123	01.83→	2	0 241 235 755	W 7 DC	0,7	
750 cc						
Tourist 750	01.10→	2	0 241 245 580	W 5 AC	0,5	

VERTEMATI

450 cc						
E 450	01.03-12.05	1	0 242 074 500	UR 07 CDC	0,7	
500 cc						
E 501	01.03-12.05	1	0 242 074 500	UR 07 CDC	0,7	
570 cc						
E 570	01.03-12.05	1	0 242 074 500	UR 07 CDC	0,7	

VOR

400 cc						
EN 400	01.00-12.02	1	0 242 060 505	UR 2 CDC	0,6	
EN 400 E	01.02-12.04	1	0 242 060 505	UR 2 CDC	0,6	



◀ VOR

MX 400	01.00-12.02		1	0 242 060 505	UR 2 CDC	0,6
SM 400	01.00-12.02		1	0 242 060 505	UR 2 CDC	0,6
500 cc						
EN 503	01.00-12.02		1	0 242 060 505	UR 2 CDC	0,6
SM 503	01.00-12.02		1	0 242 060 505	UR 2 CDC	0,6
503 cc						
MX 503	01.00-12.02		1	0 242 060 505	UR 2 CDC	0,6
525 cc						
EN 530 E	01.02-12.05		1	0 242 060 505	UR 2 CDC	0,6
EN 530 MAR	01.03-12.05		1	0 242 060 505	UR 2 CDC	0,6
SM 530	01.02-12.05		1	0 242 060 505	UR 2 CDC	0,6

WINHA

350 cc						
Winha 350	01.75-12.85			0 241 248 538	W 4 CC	0,5

YAMAHA

60 cc						
YZ 60	01.81-12.84		1	0 241 248 538	W 4 CC	0,8
80 cc						
DT 80 LC	01.83-12.84		1	0 242 250 503	WR 4 CC	0,8
	01.85-12.94		1	0 242 255 502	WR 3 CC	0,8
DT 80 MX	01.81-12.85		1	0 241 256 512	W 3 AC	0,7
DT 80 MX-S	01.83-12.87		1	0 242 260 500	WR 2 AC	0,7
FS 80	01.76-12.92		1	0 241 245 580	W 5 AC	0,7
LB 80 Bop	01.76-12.86		1	0 241 235 607	W 7 AC	0,7
LB 80 Chappy	01.76-12.86		1	0 241 235 607	W 7 AC	0,7
PW 80	01.83-12.92		1	0 242 235 665	WR 7 BC+	0,7
	01.93→		1	0 241 235 754	W 7 BC	0,7
RD 80 LC	01.82-12.86		1	0 242 250 503	WR 4 CC	0,8
RD 80 MX	01.81-12.84		1	0 241 256 512	W 3 AC	0,7
RX 80 SE	01.81-12.84		1	0 241 256 512	W 3 AC	0,7
YZ 80	01.76-12.83		1	0 241 248 538	W 4 CC	0,8
	01.84-12.85		1	0 241 256 515	W 3 CS	0,6
	01.86-12.87		1	0 242 255 504	WR 3 CS	0,6
	01.93-12.01		1	0 241 274 505	W 07 CS	0,7
100 cc						
AG 100	01.79-12.79		1	0 241 245 580	W 5 AC	0,7
DT 100	01.75-12.75		1	0 241 256 512	W 3 AC	0,7
	01.77-12.85		1	0 241 248 538	W 4 CC	0,8
DX 100	01.80-12.90		1	0 241 245 580	W 5 AC	0,7
RS 100	01.75-12.81		1	0 241 256 512	W 3 AC	0,7
RX 100	01.85-12.96	XJB	1	0 241 256 512	W 3 AC	0,7
		XJC	1	0 241 248 538	W 4 CC	0,8
RXS 100	01.83-12.97		1	0 242 260 500	WR 2 AC	0,7
SRE 102	01.97-12.03		1	0 241 056 502	U 3 AC	
SRV 102	02.04-01.07		1	0 241 056 502	U 3 AC	
SRX 102	06.01-03.04		1	0 241 056 502	U 3 AC	
V 100	01.93-12.01		1	0 241 245 656	W 5 BC	1,0
YB 100	01.94→		1	0 241 235 754	W 7 BC	0,7
YZ 100	01.76-12.84		1	0 241 274 505	W 07 CS	0,6



Typ



110 cc						
TT-R 110	01.08→		1	0 242 055 501	UR 3 AC	0,7
V 110	01.93-12.96		1	0 241 245 656	W 5 BC	1,0
125 cc						
DT 125	01.99→		1	0 242 250 503	WR 4 CC	0,8
DT 125 LC	01.82-12.85		1	0 242 250 503	WR 4 CC	0,8
	01.86-12.89		1	0 242 255 502	WR 3 CC	0,8
DT 125 MX	01.76-12.83		1	0 241 248 538	W 4 CC	0,8
DT 125 R	01.88-12.00		1	0 242 255 502	WR 3 CC	0,8
DT 125 Tenere	01.87-12.97		1	0 241 256 515	W 3 CS	0,7
			1	0 242 255 502	WR 3 CC	0,7
DT 125 12v	01.77-12.83		1	0 242 255 502	WR 3 CC	0,8
DT-Z 125 Tenere	01.88-12.92		1	0 241 256 522	W 3 CC	0,8
IT 125	01.80-12.81		1	0 241 256 515	W 3 CS	0,6
RD 125 LC	01.82-12.83		1	0 242 255 502	WR 3 CC	0,8
	01.84-12.88		1	0 242 250 503	WR 4 CC	0,8
RS 125	01.75-12.75		1	0 241 245 580	W 5 AC	0,7
	01.76-12.84		1	0 241 256 512	W 3 AC	0,7
RX 125	01.78-12.85	XJB	1	0 241 256 512	W 3 AC	0,7
		XJC	1	0 241 248 538	W 4 CC	0,8
RX 125 H	01.81-12.81		1	0 241 245 580	W 5 AC	0,7
SR 125	01.82-12.92		1	0 241 150 504	X 4 CC	0,7
	01.93-12.03		1	0 242 150 507	XR 4 CC	0,7
TDR 125	01.93-12.96		1	0 242 255 502	WR 3 CC	0,9
	01.97-12.03		1	0 242 250 503	WR 4 CC	0,8
TT-R 125	01.00-12.08		1	0 242 065 501	UR 09 AC	
TW 125	01.99-12.05		1	0 242 150 507	XR 4 CC	0,6
TZR 125	01.87-12.92		1	0 242 255 502	WR 3 CC	0,8
WR 125 X/R	01.09→		1	0 242 065 500	UR 09 CC	
XT 125	01.82-12.93		1	0 241 150 504	X 4 CC	0,7
	01.05-12.06		1	0 242 065 501	UR 09 AC	0,8
	01.07→		1	0 242 055 501	UR 3 AC	0,8
XV 125 Virago	01.97-12.01		2	0 242 055 501	UR 3 AC	0,6
XVS 125 Dragstar	01.00-12.04		2	0 242 065 501	UR 09 AC	0,6
YBR 125	01.05→		1	0 242 055 501	UR 3 AC	0,7
YZ 125	01.83-12.92		1	0 241 256 515	W 3 CS	0,6
	01.93-12.98		1	0 242 255 504	WR 3 CS	0,6
YZ 125 LC	01.99-12.05		1	0 242 255 504	WR 3 CS	0,6
YZF-R 125	01.08→		1	0 242 065 500	UR 09 CC	0,7
135 cc						
RX-Z 135	01.92→		1	0 241 245 581	W 5 CC	0,8
150 cc						
FZ 150	01.91-12.94		2	0 241 056 502	U 3 AC	0,7
FZR 150	01.86-12.98		2	0 241 056 502	U 3 AC	0,7
SR 150	01.91-12.97		1	0 241 150 504	X 4 CC	0,7
165 cc						
DT 165	01.91-12.93		1	0 242 250 503	WR 4 CC	0,8
175 cc						
DT 175	01.80-12.96		1	0 241 256 522	W 3 CC	0,8
DT 175 MX	01.78-12.86		1	0 241 248 538	W 4 CC	0,8
IT 175	01.80-12.84		1	0 241 256 515	W 3 CS	0,6
RT 180	01.90-12.98		1	0 241 248 538	W 4 CC	0,8
200 cc						
AG 200	01.93-12.94		1	0 241 150 504	X 4 CC	0,7
BW 200	01.83-12.88		1	0 241 150 504	X 4 CC	0,7



Typ



◀ YAMAHA

DT 200 LC	01.84-12.97	1	0 242 255 502	WR 3 CC	0,8
DT 200 R	01.84-12.00	1	0 242 255 502	WR 3 CC	0,8
DT 200 WR	01.90-12.93	1	0 242 255 502	WR 3 CC	0,8
IT 200	01.84-12.90	1	0 242 255 504	WR 3 CS	0,6
RD 200	01.76-12.80	2	0 241 248 538	W 4 CC	0,8
RS 200	01.78-12.85	2	0 241 248 538	W 4 CC	0,8
TW 200	01.87-12.93	1	0 242 150 507	XR 4 CC	0,7
	01.94→	1	0 241 150 504	X 4 CC	0,7
WR 200	01.92-12.94	1	0 242 255 502	WR 3 CC	0,8
225 cc					
TT 225	01.86-12.88	1	0 242 150 507	XR 4 CC	0,7
XT 225	01.89-12.07	1	0 242 150 507	XR 4 CC	0,7
240 cc					
TDR 240	01.88-12.92	2	0 242 255 502	WR 3 CC	0,8
250 cc					
FZR 250	01.87-12.97	4	0 242 068 500	UR 08 CC	10,0
IT 250	01.77-12.85	1	0 241 256 515	W 3 CS	0,6
	01.86-12.87	1	0 242 255 504	WR 3 CS	0,6
RD 250 LC	01.81-12.86	2	0 241 248 538	W 4 CC	0,8
R1-Z 250	01.90-12.93	2	0 242 255 502	WR 3 CC	0,8
SR 250	01.78-12.84	1	0 242 245 552	WR 5 DC+	0,8
	01.92-12.00	1	0 242 245 552	WR 5 DC+	0,8
TDR 250	01.88-12.92	2	0 242 255 502	WR 3 CC	0,8
TT 250	01.80-12.82	1	0 241 150 504	X 4 CC	0,7
TT 250 R	01.92-12.06	1	0 242 068 500	UR 08 CC	0,7
TZ 250	01.84-12.92	2	0 241 274 505	W 07 CS	0,5
TZR 250	01.86-12.92	2	0 242 255 502	WR 3 CC	0,8
WR 250 F	01.01→	1	0 242 065 500	UR 09 CC	0,7
WR 250 Z	01.91-12.98	1	0 242 255 504	WR 3 CS	0,6
WR 250i	01.08→	1	0 242 074 500	UR 07 CDC	0,8
XV 250 S Virago	01.97-12.00	2	0 242 055 501	UR 3 AC	0,7
XVS 250 Drag Star	01.01-12.08	2	0 242 055 501	UR 3 AC	0,7
YBR 250	01.07-12.09	1	0 242 150 507	XR 4 CC	0,7
YZ 250	01.80-12.83	1	0 241 256 515	W 3 CS	0,6
	01.84-12.96	1	0 242 255 504	WR 3 CS	0,6
YZ 250 F 4T	01.01→	1	0 242 065 500	UR 09 CC	0,7
YZ 250 LC	01.97-12.01	1	0 242 255 504	WR 3 CS	
YZ 250 2T	01.02→	1	0 242 255 504	WR 3 CS	
350 cc					
BW 350	01.87-12.89	1	0 242 150 507	XR 4 CC	0,9
RD 350	01.85-12.94	2	0 242 255 502	WR 3 CC	0,8
RD 350 LC	01.80-12.85	2	0 242 250 503	WR 4 CC	0,8
TT 350	01.86-12.97	1	0 241 150 504	X 4 CC	0,7
XT 350	01.85-12.92	1	0 242 150 507	XR 4 CC	0,6
	01.93-12.00	1	0 241 150 504	X 4 CC	0,7
400 cc					
DT 400	01.75-12.82	1	0 241 248 538	W 4 CC	0,8
DT 400 E	01.75-12.77	1	0 241 256 522	W 3 CC	0,8
FZR 400	01.86-12.95	4	0 242 065 500	UR 09 CC	0,7
IT 400	01.76-12.79	1	0 241 248 538	W 4 CC	0,8
RD 400	01.76-12.79	2	0 241 248 538	W 4 CC	0,8
WR 400 F	01.98-12.02	1	0 242 065 500	UR 09 CC	0,7
XJ 400	01.81-12.85	4	0 241 150 504	X 4 CC	0,7
XS 400 DOHC	01.82-12.90	2	0 242 150 507	XR 4 CC	0,7
XV 400	01.83-12.91	2	0 242 245 552	WR 5 DC+	0,8



YZ 400 F	01.98-12.99		1	0 242 065 500	UR 09 CC	0,7
450 cc						
IT 425	01.80-12.82		1	0 241 248 538	W 4 CC	0,8
IT 465	01.81-12.82		1	0 241 248 538	W 4 CC	0,8
WR 426 F	01.01-12.02		1	0 242 065 500	UR 09 CC	0,7
WR 450 F	01.03→		1	0 242 065 500	UR 09 CC	0,7
YZ 426 F	01.00-12.02		1	0 242 065 500	UR 09 CC	0,6
YZ 450 F	01.03→		1	0 242 065 500	UR 09 CC	0,7
YZ 465	01.80-12.81		1	0 241 248 538	W 4 CC	0,8
500 cc						
IT 490	01.83-12.85		1	0 242 250 503	WR 4 CC	0,6
RD 500 LC	01.84-12.87		4	0 242 268 500	WR 08 AC	0,7
SR 500	06.95-12.99		1	0 242 245 552	WR 5 DC+	0,6
XS 500	01.76-12.79		2	0 241 150 504	X 4 CC	0,7
XV 500 SE	01.87-12.97		2	0 242 245 552	WR 5 DC+	0,6
XV 500 Virago	01.83-12.89		2	0 242 245 552	WR 5 DC+	0,8
YZ 490	01.81-12.88		1	0 242 255 504	WR 3 CS	0,6
535 cc						
XV 535 Virago	01.87-12.96		2	0 242 245 552	WR 5 DC+	0,8
	01.97-12.03		2	0 242 235 663	WR 7 DC+	0,8
550 cc						
XJ 550	01.81-12.84		4	0 241 150 504	X 4 CC	0,6
XZ 550 Vision	01.82-12.85		2	0 242 150 507	XR 4 CC	0,6
600 cc						
FZ 6 Fazer	01.04→		4	0 242 074 500	UR 07 CDC	0,7
FZ 6 Fazer S2	01.04→		4	0 242 074 500	UR 07 CDC	0,7
FZ 600	01.86-12.89		4	0 242 150 507	XR 4 CC	0,7
FZR 600	01.89-12.99		4	0 242 068 500	UR 08 CC	0,7
FZR 600 R	01.94-01.96		4	0 242 068 500	UR 08 CC	0,7
FZS 600 Fazer	01.98-12.02	LEN	4	0 242 068 500	UR 08 CC	0,7
		LET	4	0 242 065 500	UR 09 CC	0,7
	01.03-12.03		4	0 242 074 500	UR 07 CDC	0,7
TT 600 R	01.97-12.03		1	0 242 150 505	XR 4 DC	0,9
XJ 600	01.84-12.90		4	0 242 150 507	XR 4 CC	0,7
	01.91-12.03		4	0 242 065 500	UR 09 CC	0,6
XJ6	01.09→		4	0 242 068 500	UR 08 CC	
YX 600 Radian	01.86-12.90		4	0 242 150 507	XR 4 CC	0,7
YZF 600 R Thundercat	01.96-12.03		4	0 242 068 500	UR 08 CC	0,8
YZF-R6	01.99→		4	0 242 080 500	UR 06 CDC	0,6
660 cc						
MT-03	01.05→		1	0 242 060 501	UR 2 CC	0,6
SZR 660	01.95-12.96		1	0 242 150 505	XR 4 DC	0,9
XT 660	01.04→		1	0 242 060 501	UR 2 CC	0,6
XTZ 660	01.91-12.96		1	0 242 150 505	XR 4 DC	0,9
	01.94-12.95		1	0 242 150 507	XR 4 CC	0,9
750 cc						
FZ 750	01.85-12.94		4	0 242 150 507	XR 4 CC	0,7
FZR 750	01.88-12.92		4	0 242 150 507	XR 4 CC	0,7
FZX 750	01.85-12.97		4	0 242 150 507	XR 4 CC	0,6
XV 750	01.84-12.97		2	0 242 245 552	WR 5 DC+	0,8
YZF 750	01.93-12.98		4	0 242 068 500	UR 08 CC	0,8
800 cc						
FZ8 Fazer	01.10→		4	0 242 068 500	UR 08 CC	
850 cc						
TRX 850	01.96-12.96		2	0 242 150 505	XR 4 DC	0,9



◀ YAMAHA

1000 cc					
FZR 1000 Exup	01.89-12.95	4	0 242 150 507	XR 4 CC	0,7
FZR 1000 Genesis	01.87-12.88	4	0 242 150 507	XR 4 CC	0,7
FZS 1000 Fazer	01.01-12.07	4	0 242 068 500	UR 08 CC	0,7
FZ1 Fazer	01.06→	4	0 242 074 500	UR 07 CDC	0,7
TR 1	01.80-12.84	2	0 242 245 552	WR 5 DC+	0,7
XV 1000	01.81-12.89	2	0 242 245 552	WR 5 DC+	0,7
YZF 1000 R Thunderace	01.96-12.03	4	0 242 150 507	XR 4 CC	0,7
YZF-R1	01.98-12.01	4	0 242 068 500	UR 08 CC	0,7
	01.04→	4	0 242 074 500	UR 07 CDC	0,7
1100 cc					
BT 1100 Bulldog	01.02-12.06	2	0 242 245 552	WR 5 DC+	0,6
XV 1100 Virago	01.86-12.99	2	0 242 245 552	WR 5 DC+	0,8
XVS 1100	01.99-12.08	2	0 242 245 552	WR 5 DC+	0,7
1300 cc					
FJR 1300	01.01→	4	0 242 065 500	UR 09 CC	0,7

ZID

175 cc					
Sova 175	01.93-12.99	1	0 241 245 656	W 5 BC	0,6
200 cc					
Courier 200	01.97-12.02	1	0 241 245 656	W 5 BC	0,7
Farmer 200	01.93-12.99	1	0 241 245 656	W 5 BC	0,7
Sova 200	01.95-12.01	1	0 241 245 656	W 5 BC	0,7

ZUENDAPP

80 cc					
K 80	12.80-10.84	1	0 241 248 538	W 4 CC	0,5
KS 80	12.80-10.84	1	0 241 248 538	W 4 CC	0,5
KS 80 Super	12.80-10.84	1	0 241 248 538	W 4 CC	0,5
KS 80 Touring	01.81-12.83	1	0 241 248 538	W 4 CC	0,5
175 cc					
KS 175	07.77-08.82	1	0 241 248 538	W 4 CC	0,5



Typ



APRILIA

25 cc						
Amico 25	01.96→	1	0 242 245 517	WR 5 AC		0,5
50 cc						
Amico Sport	01.91-12.97	1	0 242 245 517	WR 5 AC		0,6
Amico 50	01.90→	1	0 242 245 517	WR 5 AC		0,6
Area 51	01.98-12.03	1	0 242 260 500	WR 2 AC		0,7
Gulliver 50 AC	09.95-12.99	1	0 242 245 517	WR 5 AC		0,6
Gulliver 50 LC	01.96-12.99	1	0 242 260 500	WR 2 AC		0,6
Habana 50	01.99-12.02	1	0 242 245 531	WR 5 BC		0,6
Mojito 50	01.04-12.08	1	0 242 265 500	WR 09 CC		0,6
Mojito 50 Custom	01.99-12.03	1	0 242 245 531	WR 5 BC		0,6
Rally 50 AC	01.95-12.04	1	0 242 245 517	WR 5 AC		0,5
Rally 50 LC	01.95-12.01	1	0 242 260 500	WR 2 AC		0,6
Scarabeo 50 DiTech	07.00-12.05	1	0 242 055 509	UR 3 DC		0,6
Scarabeo 50 2T	01.93-12.05	1	0 242 245 517	WR 5 AC		0,5
	01.06→	1	0 242 250 503	WR 4 CC		0,6
Scarabeo 50 4T	01.02-12.09	1	0 242 065 500	UR 09 CC		0,7
Sonic 50 AC	01.98-12.07	1	0 242 245 517	WR 5 AC		0,5
Sonic 50 LC	01.98-12.08	1	0 242 260 500	WR 2 AC		0,6
SportCity One 50 2T	01.08-12.11	1	0 242 250 503	WR 4 CC		0,6
SportCity One 50 4T	01.08-12.10	1	0 242 065 500	UR 09 CC		0,7
SR 50	01.93-12.98	1	0 242 245 517	WR 5 AC		0,5
SR 50 AC	01.92-12.96	1	0 242 245 517	WR 5 AC		0,6
SR 50 DiTech	01.00-12.05	1	0 242 055 509	UR 3 DC		0,6
SR 50 Esquire	01.95-12.99	1	0 242 245 517	WR 5 AC		0,5
SR 50 H2O	01.00-12.03	1	0 242 245 531	WR 5 BC		0,6
SR 50 LC	01.93-12.99	1	0 242 260 500	WR 2 AC		0,6
SR 50 LC Street	01.03→	1	0 242 265 500	WR 09 CC		0,6
SR 50 R	01.04→	1	0 242 055 509	UR 3 DC		
		1	0 242 265 500	WR 09 CC		
SR 50 Replica	01.95-12.00	1	0 242 245 517	WR 5 AC		0,5
100 cc						
Scarabeo 100 2T	01.00-12.00	1	0 242 260 500	WR 2 AC		0,6
Scarabeo 100 4T	01.01→	1	0 242 068 500	UR 08 CC		0,7
125 cc						
Atlantic 125	01.03-12.11	1	0 242 065 500	UR 09 CC		0,6
Habana 125	01.99-12.02	1	0 242 060 501	UR 2 CC		0,7
Leonardo 125	01.96-12.04	1	0 242 065 500	UR 09 CC		0,7
Mojito 125	01.99→	1	0 242 060 501	UR 2 CC		0,7
Scarabeo 125	01.99-12.08	1	0 242 065 500	UR 09 CC		0,6
Sportcity Cube 125	01.08→	1	0 242 060 501	UR 2 CC		0,7
Sportcity 125	01.02-12.06	1	0 242 060 501	UR 2 CC		0,7
		1	0 242 065 500	UR 09 CC		0,6
	01.07-12.08	1	0 242 065 500	UR 09 CC		0,7
SR 125	01.99-12.04	1	0 242 250 503	WR 4 CC		0,6
SR 125 Motard	01.12→	1	0 242 060 501	UR 2 CC		
150 cc						
Leonardo 150	01.97-12.01	1	0 242 065 500	UR 09 CC		0,7
	01.02-12.04	1	0 242 150 507	XR 4 CC		0,6
Mojito 150	01.03-12.07	1	0 242 060 501	UR 2 CC		0,7



A



◀ APRILIA

Scarabeo 150	01.99-12.03	1	0 242 065 500	UR 09 CC	0,6
SR 150	01.99-12.01	1	0 242 255 502	WR 3 CC	0,6
200 cc					
Atlantic 200	01.03-12.05	1	0 242 065 500	UR 09 CC	0,7
Scarabeo 200	01.06-12.08	1	0 242 065 500	UR 09 CC	0,7
Scarabeo 200 Rotax	01.99-12.04	1	0 242 065 500	UR 09 CC	0,6
Sportcity 200	01.05-12.10	1	0 242 060 501	UR 2 CC	0,7
250 cc					
Atlantic 250	01.03-12.06	1	0 242 065 500	UR 09 CC	0,7
Leonardo 250	01.98-12.04	1	0 242 150 507	XR 4 CC	0,6
Scarabeo 250	01.04-12.06	1	0 242 065 500	UR 09 CC	0,7
300 cc					
Leonardo 300	01.02-12.06	1	0 242 150 507	XR 4 CC	0,6

ATALA

50 cc

Byte 25	01.96→	1	0 242 235 665	WR 7 BC+	0,6
Byte 50	01.96→	1	0 242 235 665	WR 7 BC+	0,6
Carosello 50	01.99→	1	0 241 245 580	W 5 AC	0,6
Hacker 50	01.96-12.99	1	0 242 235 665	WR 7 BC+	0,6
Master 50	01.96→	1	0 241 235 607	W 7 AC	0,5
Skeggia 50	01.98→	1	0 242 235 665	WR 7 BC+	0,6

BAJAJ AUTO

50 cc

Spirit 50	01.99→	1	0 241 235 607	W 7 AC	0,5
Sunny 50	01.92-12.98	1	0 241 235 607	W 7 AC	0,5
125 cc					
Chetak 125 Elektrik	01.93-12.98	1	0 241 235 754	W 7 BC	0,6

BENELLI

50 cc

K2 50 AC	01.98-12.04	1	0 242 245 517	WR 5 AC	0,6	
K2 50 LC	01.98-12.04	1	0 242 260 500	WR 2 AC	0,7	
Naked 50	01.98-12.06	1	0 242 260 500	WR 2 AC	0,6	
Pepe 50	01.99-12.04	KAT KAF	1	0 242 260 500	WR 2 AC	0,6
			1	0 242 245 517	WR 5 AC	0,6
S 50 Kat	01.90-12.96	1	0 242 235 533	WR 7 AC	0,6	
Scooty 50	01.93→	1	0 241 235 607	W 7 AC	0,6	
491 50	01.97-12.99	1	0 242 245 517	WR 5 AC	0,7	
	01.97-12.06	1	0 242 250 503	WR 4 CC	0,6	
	01.00-12.06	1	0 242 260 500	WR 2 AC	0,7	
100 cc						
K2 100	01.99-12.04	1	0 242 260 500	WR 2 AC	0,7	
125 cc						
Adiva 125	01.01-12.06	1	0 242 065 500	UR 09 CC	0,6	
Scooter S 125	01.85-12.93	1	0 241 245 580	W 5 AC	0,5	
Scooter 125	06.95→	1	0 241 245 580	W 5 AC	0,5	
Velvet 125	01.99-12.04	1	0 242 065 500	UR 09 CC	0,6	



Typ



125 S	01.84-06.89	1	0 242 245 517	WR 5 AC	0,6
150 cc					
Adiva 150	01.99-12.04	1	0 242 065 500	UR 09 CC	0,6
Velvet 150	01.99-12.04	1	0 242 065 500	UR 09 CC	0,6
	01.09→	1	0 242 065 500	UR 09 CC	
250 cc					
Velvet 250	01.99-12.04	1	0 242 150 507	XR 4 CC	0,7
400 cc					
Velvet Dusk 400	01.02-12.03	1	0 242 068 500	UR 08 CC	0,7

BETA-INTERMOTOR

50 cc					
Ark 50 AC	01.97-12.09	1	0 242 245 517	WR 5 AC	0,6
Ark 50 LC	01.97-12.09	1	0 242 260 500	WR 2 AC	0,6
Chrono 50	01.92-12.03	1	0 242 245 517	WR 5 AC	0,5
Chrono 502	01.95-12.97	1	0 242 245 517	WR 5 AC	0,5
Eikon 50	01.98-12.06	1	0 242 260 500	WR 2 AC	0,6
Quadra 50	01.97-12.05	1	0 242 245 517	WR 5 AC	0,6
Tempo Crono 50	01.93-12.01	1	0 242 245 517	WR 5 AC	0,5
Tempo 50	01.93-12.01	1	0 242 245 517	WR 5 AC	0,5
125 cc					
Eikon 125	01.99-12.05	1	0 242 150 507	XR 4 CC	0,6

BMW

125 cc					
C 1 125	03.00-04.03	1	0 242 065 500	UR 09 CC	0,6
200 cc					
C 1 200	03.01-02.03	1	0 242 065 500	UR 09 CC	0,6

BS VILLA

50 cc					
Giorno 50	01.90-12.98	1	0 242 255 515	WR 3 BC 0	0,6
GP 50	01.93-12.00	1	0 242 245 531	WR 5 BC	0,6
SP 50	01.93-12.00	1	0 242 240 561	WR 6 BC	0,6
ZX 50	01.93-12.00	1	0 242 255 515	WR 3 BC 0	0,6
Z5 50	01.93-12.00	1	0 242 255 515	WR 3 BC 0	0,6

CAGIVA

50 cc					
City 50	01.92-12.93	1	0 241 245 580	W 5 AC	0,5
	01.94-12.97	1	0 242 245 531	WR 5 BC	0,6
	01.98-12.98	1	0 242 255 515	WR 3 BC 0	0,5
Cucciolo 50	01.98-12.00	1	0 241 256 512	W 3 AC	0,6
Mantis 50	01.98-12.01	1	0 241 256 522	W 3 CC	0,6
Passing 50	01.94-12.98	1	0 241 235 754	W 7 BC	0,6
Progress Corsa 50	01.98-12.01	1	0 241 256 522	W 3 CC	0,6
Progress 50	01.97-12.01	1	0 241 256 512	W 3 AC	0,6



◀ CAGIVA

Scooter 50	01.93→	1	0 242 255 515	WR 3 BC 0	0,7
Super City 50	01.91-12.96	1	0 241 248 538	W 4 CC	0,5
110 cc					
Passing 110	01.93-12.94	1	0 242 235 665	WR 7 BC+	0,6
125 cc					
Cucciolo 125	01.98-12.03	1	0 242 060 501	UR 2 CC	0,7
Nuvola 125	01.99-12.02	1	0 242 060 501	UR 2 CC	0,7
Passing 125	01.94-12.98	1	0 241 235 754	W 7 BC	0,6

CAN-AM

1000 cc

Spyder Roadster	01.08→	2	0 242 150 506	YR 4 DE	0,7
-----------------	--------	---	---------------	---------	-----

CCF

100 cc

Adly 100	01.98-12.01	1	0 241 245 656	W 5 BC	0,6
----------	-------------	---	---------------	--------	-----

125 cc

Cat 125	01.98-12.02	1	0 242 065 501	UR 09 AC	0,6
---------	-------------	---	---------------	----------	-----

CPI

50 cc

Aragon 50	06.06→	1	0 242 245 521	WR 5 CC	0,8
-----------	--------	---	---------------	---------	-----

Bingo 50	01.02-12.02	1	0 242 255 515	WR 3 BC 0	0,6
----------	-------------	---	---------------	-----------	-----

GTR 50	01.03→	1	0 242 245 521	WR 5 CC	0,8
--------	--------	---	---------------	---------	-----

GTS 50	01.02-12.03	1	0 242 245 521	WR 5 CC	0,8
--------	-------------	---	---------------	---------	-----

Hussar 50	01.01-12.05	EU2	1	0 242 245 521	WR 5 CC	0,8
-----------	-------------	-----	---	---------------	---------	-----

		EU2	1	0 242 255 515	WR 3 BC 0	0,6
--	--	-----	---	---------------	-----------	-----

Oliver 50	01.03→	1	0 242 245 521	WR 5 CC	0,8
-----------	--------	---	---------------	---------	-----

Popcorn 50	01.00-12.05	EU2	1	0 242 245 521	WR 5 CC	0,8
------------	-------------	-----	---	---------------	---------	-----

		EU2	1	0 242 255 515	WR 3 BC 0	0,6
--	--	-----	---	---------------	-----------	-----

Tennessee 50	01.01-12.01	1	0 242 255 515	WR 3 BC 0	0,6
--------------	-------------	---	---------------	-----------	-----

125 cc

Aragon 125	01.06→	1	0 242 065 501	UR 09 AC	0,6
------------	--------	---	---------------	----------	-----

GTS 125	01.02-12.09	1	0 242 245 521	WR 5 CC	0,8
---------	-------------	---	---------------	---------	-----

X-Large 125	01.03→	1	0 242 245 521	WR 5 CC	0,8
-------------	--------	---	---------------	---------	-----

150 cc

GTS 150	01.02-12.05	1	0 242 245 521	WR 5 CC	0,8
---------	-------------	---	---------------	---------	-----

X-Large 150	01.03-12.03	1	0 242 245 521	WR 5 CC	0,8
-------------	-------------	---	---------------	---------	-----

200 cc

GTS 200	01.02-12.09	1	0 242 245 521	WR 5 CC	0,8
---------	-------------	---	---------------	---------	-----

X-Large 200	01.02-12.03	1	0 242 245 521	WR 5 CC	0,8
-------------	-------------	---	---------------	---------	-----

DAELIM

50 cc

Cordi 50	01.06→	1	0 242 235 665	WR 7 BC+	0,6
----------	--------	---	---------------	----------	-----

E-Five 50	01.03→	1	0 242 255 515	WR 3 BC 0	0,6
-----------	--------	---	---------------	-----------	-----

Message 50	01.98→	1	0 242 255 515	WR 3 BC 0	0,6
------------	--------	---	---------------	-----------	-----



S-Five 50	01.02→	1	0 242 255 515	WR 3 BC 0	0,6
Tapo 50	01.99→	1	0 242 255 515	WR 3 BC 0	0,6
100 cc					
Delfino 100	01.98→	1	0 242 260 500	WR 2 AC	0,6
110 cc					
Citi Ace 110	01.06→	1	0 241 056 502	U 3 AC	0,7
125 cc					
Besbi 125	01.09→	1	0 242 055 508	UHR 3 CC	0,9
Fellow 125	01.98-12.99	1	0 242 055 508	UHR 3 CC	0,9
Freewing 125 S2	01.05→	1	0 242 055 508	UHR 3 CC	0,9
History 125	01.01→	1	0 242 055 508	UHR 3 CC	0,9
NS 125	01.98→	1	0 242 055 508	UHR 3 CC	0,9
Otello 125	01.98→	1	0 242 055 508	UHR 3 CC	0,9
S2 125 FI Freewing	01.07→	1	0 242 055 508	UHR 3 CC	0,9

DERBI

50 cc					
Atlantis 50 AC	01.99-12.02	1	0 241 256 512	W 3 AC	0,6
	01.03→	1	0 242 255 502	WR 3 CC	0,6
Atlantis 50 LC	01.99-12.03	1	0 241 256 522	W 3 CC	0,6
Aventura 50	01.95-12.98	1	0 241 256 512	W 3 AC	0,6
Boulevard 50 2T	01.09→	1	0 242 255 502	WR 3 CC	0,6
Furax 50	01.95-12.97	1	0 241 256 512	W 3 AC	0,6
GP1 50	01.98→	1	0 242 265 500	WR 09 CC	0,6
Hunter 50	01.95-12.98	1	0 241 245 656	W 5 BC	0,6
		1	0 241 256 512	W 3 AC	0,6
Manhattan 50	01.98-12.99	1	0 241 256 512	W 3 AC	0,6
Paddock 50 AC	01.96-12.99	1	0 241 256 512	W 3 AC	0,6
Paddock 50 LC	01.98-12.99	1	0 241 256 522	W 3 CC	0,6
Predator 50 AC	01.98-12.02	1	0 241 256 512	W 3 AC	0,6
		1	0 241 256 522	W 3 CC	0,6
Predator 50 LC	01.98-12.02	1	0 241 256 522	W 3 CC	0,6
Rambla 50	01.06-12.07	1	0 242 255 502	WR 3 CC	0,6
Start 50 DS	01.83-12.93	1	0 241 245 580	W 5 AC	0,5
Vamos 50	01.93-12.95	1	0 241 256 512	W 3 AC	0,5
	01.96-12.99	1	0 242 260 500	WR 2 AC	0,6

100 cc					
Atlantis 100	01.01-12.06	1	0 241 256 522	W 3 CC	0,6
125 cc					
Boulevard 125	01.03→	1	0 242 068 500	UR 08 CC	0,7
Rambla 125	01.09→	1	0 242 255 502	WR 3 CC	0,6
150 cc					
Boulevard 150	01.03→	1	0 242 068 500	UR 08 CC	0,7

EPPELLA

125 cc					
G-Max 125	01.07→	1	0 242 065 501	UR 09 AC	0,6





Zyl.



Typ

**FANTIC****50 cc**

Grinta 50	01.95-12.96	1	0 241 245 656	W 5 BC	0,6
Queenie 50	01.95-12.96	1	0 241 245 656	W 5 BC	0,6

GARELLI (AGRATI-GARELLI)**50 cc**

Flo 50	01.00-12.10	1	0 242 240 561	WR 6 BC	0,6
Grinta 50	01.93-12.96	1	0 241 245 656	W 5 BC	0,6
Hussar 50	01.00-12.01	1	0 242 255 515	WR 3 BC 0	0,6
KRC 50	01.01-12.02	1	0 242 268 500	WR 08 AC	0,6
KRS 50	01.01-12.02	1	0 242 268 500	WR 08 AC	0,6
M 901 50	01.98-12.99	1	0 242 268 500	WR 08 AC	0,6
PMX 50	01.00-12.01	1	0 242 240 561	WR 6 BC	0,6
Pony 50	01.92-12.97	1	0 241 245 656	W 5 BC	0,6
Queenie 50	01.92-12.97	1	0 241 245 656	W 5 BC	0,6
Raider 50	01.86-12.91	1	0 242 268 500	WR 08 AC	0,6
Roadshow 50	01.86-12.91	1	0 242 268 500	WR 08 AC	0,6
Starter 50	01.01-12.02	1	0 242 268 500	WR 08 AC	0,6
303 50	01.99-12.01	1	0 242 240 561	WR 6 BC	0,6

125 cc

Blast 125	01.99-12.01	1	0 242 065 501	UR 09 AC	0,5
Hussar 125	01.00-12.01	1	0 242 065 501	UR 09 AC	0,6
Joker 125	01.01-12.03	1	0 242 065 501	UR 09 AC	0,7
T-Rex 125	01.99-12.10	1	0 242 065 501	UR 09 AC	0,6
303R 125	01.99-12.01	1	0 242 065 501	UR 09 AC	0,5

150 cc

Freeland 150	01.01-12.02	1	0 242 065 501	UR 09 AC	0,7
Joker 150	01.01-12.02	1	0 242 065 501	UR 09 AC	0,7
T-Rex 150	01.99-12.01	1	0 242 065 501	UR 09 AC	0,5

GILERA (PIAGGIO)**50 cc**

CBA 50 R	01.82-12.89	1	0 241 235 607	W 7 AC	0,5
Easy Moving 50	01.95-12.99	1	0 241 256 522	W 3 CC	0,6
GSA Lusso	03.82-12.93	1	0 241 235 607	W 7 AC	0,5
Ice 50	01.00-12.03	1	0 242 255 502	WR 3 CC	0,6
Runner 50	01.97-12.02	1	0 241 256 515	W 3 CS	0,6
Runner 50 DD	01.97-12.02	1	0 241 256 522	W 3 CC	0,6
Runner 50 DiTech	01.05→	1	0 242 055 509	UR 3 DC	0,6
Runner 50 PureJet	01.03→	1	0 242 055 509	UR 3 DC	0,6
Runner 50 Racing Replica	01.04-12.07	1	0 242 255 502	WR 3 CC	0,6
Runner 50 RST	01.05→	1	0 241 256 522	W 3 CC	0,5
Runner 50 SP	01.99→	1	0 242 255 502	WR 3 CC	0,6
SI Tuttorosso 50	01.85-12.93	1	0 242 235 533	WR 7 AC	0,5
Stalker 50	01.97-12.06	1	0 241 256 522	W 3 CC	0,6
Storm 50	01.93-12.98	1	0 241 256 522	W 3 CC	0,5
Typhoon 50/Martini Racing/Benetton F1	01.93-12.99	1	0 241 256 522	W 3 CC	0,6



Typ



125 cc						
Runner 125 FX	01.98-12.03	1	0 241 256 522	W 3 CC	0,6	
Runner 125 ST	01.08→	1	0 242 065 500	UR 09 CC	0,7	
Runner 125 VX	01.01-12.07	1	0 242 065 500	UR 09 CC	0,7	
Typhoon 125	01.93-12.98	1	0 241 256 522	W 3 CC	0,6	
150 cc						
Runner 150	01.98→	1	0 242 255 502	WR 3 CC	0,6	
180 cc						
Runner FX-R 180 DD SP	01.98-12.03	1	0 241 256 522	W 3 CC	0,6	
Runner VX-R 180	01.01-12.04	1	0 242 068 500	UR 08 CC	0,6	
200 cc						
Runner VX-R 200	01.02-12.08	1	0 242 065 500	UR 09 CC	0,6	

HERKULES MOTOR

50 cc						
BT 50	01.05→	1	0 241 056 502	U 3 AC	0,7	
TB 50	01.05→	1	0 242 240 561	WR 6 BC	0,6	

HMZ

50 cc						
Cab SB 50	01.96→	1	0 241 235 754	W 7 BC	0,6	

HONDA

50 cc						
DJ-1R	01.87-12.97	1	0 242 235 665	WR 7 BC+	0,6	
NB 50	01.83-12.85	1	0 242 235 665	WR 7 BC+	0,7	
NE 50 Vision	01.85-12.94	1	0 242 245 577	WR 5 BC 0	0,7	
NH 50	01.83-12.94	1	0 242 235 665	WR 7 BC+	0,6	
SFX 50	01.96-12.01	1	0 242 245 577	WR 5 BC 0	0,6	
SGX 50	01.97-12.01	1	0 242 245 577	WR 5 BC 0	0,6	
SGX 50 Sky	01.98-12.03	1	0 242 240 561	WR 6 BC	0,7	
SH 50 City Express	01.84-12.86	1	0 242 260 500	WR 2 AC	0,7	
	01.87-12.97	1	0 242 235 665	WR 7 BC+	0,6	
SH 50 Scoopy	01.95-12.04	1	0 242 245 577	WR 5 BC 0	0,7	
SJ 50 Bali	01.93-12.02	1	0 242 245 577	WR 5 BC 0	0,6	
Sky 50 DX	01.96-12.00	1	0 242 245 577	WR 5 BC 0	0,6	
SRX 50	01.97-12.99	1	0 242 245 577	WR 5 BC 0	0,5	
SRX 50 Shadow	01.97-12.99	1	0 242 245 577	WR 5 BC 0	0,6	
SZX 50 X8R-S	01.98-12.01	1	0 242 245 577	WR 5 BC 0	0,6	
SZX 50 X8R-X	01.98-12.01	1	0 242 245 577	WR 5 BC 0	0,6	
80 cc						
NH 80	01.83-12.94	1	0 242 235 665	WR 7 BC+	0,7	
NH 80 Lead	01.82-12.96	1	0 242 235 665	WR 7 BC+		
SH 80 Scoopy	01.84-12.96	1	0 242 235 665	WR 7 BC+	0,7	
90 cc						
SRX 90	01.97-12.99	1	0 242 245 577	WR 5 BC 0	0,7	
100 cc						
Lead 100	01.03-12.07	1	0 242 055 501	UR 3 AC	0,7	
SH 100	01.96-12.01	1	0 242 245 577	WR 5 BC 0	0,6	



◀ HONDA

SJ 100 EX Bali 110 cc	01.96-12.99	1	0 242 245 577	WR 5 BC 0	0,6
NHX 110 WH Lead 125 cc	01.08→	1	0 242 055 508	UHR 3 CC	0,9
FES 125 Pantheon	01.98-12.02	1	0 242 250 503	WR 4 CC	0,7
	01.03-12.06	1	0 242 055 508	UHR 3 CC	0,9
FES 125 S-Wing /A	01.07→	1	0 242 055 508	UHR 3 CC	0,9
NES 125 at	01.00-12.04	1	0 242 055 508	UHR 3 CC	0,9
NH 125 Lead	01.83-12.87	1	0 242 235 665	WR 7 BC+	0,7
PES 125	01.06→	1	0 242 055 508	UHR 3 CC	0,9
SES 125 Dylan	01.02-12.06	1	0 242 055 508	UHR 3 CC	0,9
SH 125	01.01-12.04	1	0 242 055 508	UHR 3 CC	0,9
SH 125i Scoopy 150 cc	01.05→	1	0 242 055 508	UHR 3 CC	0,9
FES 150 Phateon	01.98-12.02	1	0 242 250 503	WR 4 CC	
	01.03-12.06	1	0 242 055 508	UHR 3 CC	0,9
FES 150 S-Wing	01.07-12.09	1	0 242 055 508	UHR 3 CC	0,9
NES 150 at	01.00-12.06	1	0 242 055 508	UHR 3 CC	0,9
PES 150	01.06→	1	0 242 055 508	UHR 3 CC	0,9
SES 150 Dylan	01.02-12.07	1	0 242 055 508	UHR 3 CC	0,9
SH 150	01.01-12.04	1	0 242 055 508	UHR 3 CC	0,9
SH 150i 400 cc	01.05→	1	0 242 055 508	UHR 3 CC	0,9
SilverWing 400	01.06-12.08	2	0 242 055 508	UHR 3 CC	0,9
SW-T 400 /A 600 cc	01.09→	2	0 242 055 508	UHR 3 CC	0,9
FJS 600 Silver Wing /A	01.01-12.07	2	0 242 055 508	UHR 3 CC	0,9

HYOSUNG

50 cc					
SB 50	01.95-12.99	1	0 241 235 754	W 7 BC	0,6
SD 50	01.99-12.07	1	0 241 235 754	W 7 BC	0,6
SF 50	01.04→	1	0 242 255 515	WR 3 BC 0	0,6
SF 50 Prima 100 cc	01.99-12.03	1	0 242 255 515	WR 3 BC 0	0,6
EZ 100 Supercab 125 cc	01.97-12.03	1	0 241 245 656	W 5 BC	0,6
Grand Prix 125	01.99-12.03	1	0 242 150 507	XR 4 CC	0,6
Hyper 125	01.98-12.03	1	0 242 150 507	XR 4 CC	0,6
MS1 125	01.02-12.04	1	0 242 150 507	XR 4 CC	0,6

ITALJET

50 cc					
Ascot 50	01.91-12.98	1	0 241 245 656	W 5 BC	0,6
Bazooka 50	01.91-12.95	1	0 241 245 656	W 5 BC	0,6
Cruise 50	01.93-12.98	1	0 241 235 754	W 7 BC	0,6
Formula 50 AC	01.95-12.97	1	0 242 235 665	WR 7 BC+	0,6
	01.98-12.08	1	0 242 245 517	WR 5 AC	0,6
Formula 50 LC	01.97-12.08	1	0 242 260 500	WR 2 AC	0,6
Pista 50	01.92-12.97	1	0 241 245 656	W 5 BC	0,6
Reporter 50	01.90-12.95	1	0 241 245 656	W 5 BC	0,6



Typ



Scoop 50	01.91-12.95	1	0 241 245 656	W 5 BC	0,6
Sunny 50	01.95-12.98	1	0 241 235 754	W 7 BC	0,6
Velocifero 50	01.94-12.97	1	0 242 235 665	WR 7 BC+	0,7
	01.98-12.08	1	0 242 260 500	WR 2 AC	0,6
Yankee 50	01.93-12.97	1	0 241 245 656	W 5 BC	0,6
100 cc					
Millenium 100	01.00-12.03	1	0 242 245 517	WR 5 AC	0,6
125 cc					
Dragster 125	01.97-12.97	1	0 241 245 580	W 5 AC	0,6
	01.98-12.08	1	0 242 255 502	WR 3 CC	0,6
Formula 125	09.96-12.97	2	0 241 245 580	W 5 AC	0,6
	09.96-12.08	2	0 242 245 517	WR 5 AC	0,6
	01.98-12.08	2	0 242 260 500	WR 2 AC	0,6
Jet-Set 125	01.02-12.08	1	0 242 060 501	UR 2 CC	0,6
Jupiter 125	01.01-12.03	1	0 242 065 500	UR 09 CC	0,7
Millenium 125	01.00-12.03	1	0 242 065 500	UR 09 CC	0,7
Torpedo 125	01.99-12.08	1	0 242 060 501	UR 2 CC	0,7
150 cc					
Jet-Set 150	01.01-12.08	1	0 242 060 501	UR 2 CC	0,6
Jupiter 150	01.01-12.02	1	0 242 065 500	UR 09 CC	0,7
Millenium 150	01.00-12.02	1	0 242 065 500	UR 09 CC	0,7
180 cc					
Dragster 180	01.98-12.04	1	0 242 255 502	WR 3 CC	0,6
250 cc					
Jupiter 250	01.01-12.03	1	0 242 150 507	XR 4 CC	0,6
Millenium 250	01.99-12.08	1	0 242 150 507	XR 4 CC	0,6

ITTECO

50 cc					
Hornet TR 50	01.93-12.00	1	0 241 235 754	W 7 BC	0,6

JINLUN

50 cc					
Star Quad JL50QT-5	01.06→	1	0 241 056 502	U 3 AC	0,7

KEEWAY

50 cc					
Easy 25	01.09→	1	0 242 245 521	WR 5 CC	0,8
Easy 45	01.09→	1	0 242 245 521	WR 5 CC	0,8
Flash 25	01.07→	1	0 242 245 521	WR 5 CC	0,8
Flash 45	01.07→	1	0 242 245 521	WR 5 CC	0,8
Focus 25	01.05→	1	0 242 245 521	WR 5 CC	0,8
Focus 45	01.05→	1	0 242 245 521	WR 5 CC	0,8
Hurricane 25	01.07→	1	0 242 245 521	WR 5 CC	0,8
Hurricane 45	01.05→	1	0 242 245 521	WR 5 CC	0,8
Matrix 25	01.05→	1	0 242 245 521	WR 5 CC	0,8
Matrix 45	01.05→	1	0 242 245 521	WR 5 CC	0,8
RY 8 25	01.07→	1	0 242 245 521	WR 5 CC	0,8
RY 8 45	01.07→	1	0 242 245 521	WR 5 CC	0,8





◀ KEEWAY

125 cc					
Arn 125	01.05→	1	0 242 055 501	UR 3 AC	0,7
F-Act 125	01.08→	1	0 242 065 501	UR 09 AC	0,6
Focus 125	01.05→	1	0 242 055 501	UR 3 AC	0,7
Matrix 125 V1	01.05→	1	0 242 055 501	UR 3 AC	0,7
Matrix 125 V2	01.09→	1	0 242 065 501	UR 09 AC	0,6

KINETIC

50 cc					
Pride 50	01.95-12.99	1	0 241 245 656	W 5 BC	0,6
70 cc					
Pride 70	01.95-12.99	1	0 241 245 656	W 5 BC	0,6

KREIDLER

50 cc					
Florett RMC 25	01.05→	1	0 242 240 561	WR 6 BC	0,6
Florett RMC 50	01.05→	1	0 242 240 561	WR 6 BC	0,6
Florett 25	01.96→	1	0 242 240 561	WR 6 BC	0,6
Florett 25 XL	01.96→	1	0 242 240 561	WR 6 BC	0,6
Florett 50	01.96→	1	0 242 240 561	WR 6 BC	0,6
Florett 50 XL	01.96→	1	0 242 240 561	WR 6 BC	0,6
Flory RC 25	01.05→	1	0 242 240 561	WR 6 BC	0,6
Flory RC 50	01.05→	1	0 242 240 561	WR 6 BC	0,6
Flory 25	01.96→	1	0 242 240 561	WR 6 BC	0,6
Flory 50	01.96→	1	0 242 240 561	WR 6 BC	0,6
MK 50	01.96→	1	0 242 240 561	WR 6 BC	0,6
125 cc					
Florett RMC 125	01.04→	1	0 242 065 501	UR 09 AC	0,5
Flory 125	01.98→	1	0 242 065 501	UR 09 AC	0,5
Mustang 125	01.85-12.95	1	0 242 065 501	UR 09 AC	0,5

KTM

50 cc					
Chrono 50	01.94-12.99	1	0 242 245 517	WR 5 AC	0,5
K 50	01.96→	1	0 242 245 517	WR 5 AC	0,5

KYMCO

50 cc					
Agility 50 4T	01.03→	1	0 242 065 501	UR 09 AC	0,5
Calipso 50	01.96→	1	0 242 260 500	WR 2 AC	0,6
Cobra 50 Cross	01.95-12.04	1	0 242 255 515	WR 3 BC 0	0,6
Cobra 50 Racer	01.95-12.04	1	0 242 255 515	WR 3 BC 0	0,6
CX 50	05.95→	1	0 242 255 515	WR 3 BC 0	0,6
Dink 50	09.98-12.03	1	0 242 065 501	UR 09 AC	0,5
Dink 50 LC	09.98-12.03	1	0 242 245 577	WR 5 BC 0	0,6
DJ 50 Refined	01.03→	1	0 242 255 515	WR 3 BC 0	0,6
DJW 50	01.93→	1	0 242 255 515	WR 3 BC 0	0,6



Typ



Fever	05.96→	1	0 242 255 515	WR 3 BC 0	0,6
Filly 50	01.98-12.05	1	0 241 056 502	U 3 AC	0,7
Grand Dink 50	01.05→	1	0 242 255 515	WR 3 BC 0	0,6
Heroism 50	05.96-12.03	1	0 242 255 515	WR 3 BC 0	0,6
K 12	05.96-12.06	1	0 242 255 515	WR 3 BC 0	0,6
KB 50	05.98→	1	0 242 255 515	WR 3 BC 0	0,6
People 50	01.98→	1	0 242 255 515	WR 3 BC 0	0,6
Scout 50	01.95-12.03	1	0 242 255 515	WR 3 BC 0	0,6
Sniper 50	01.93-12.96	1	0 242 255 515	WR 3 BC 0	0,6
Spacer 50	01.95-12.05	1	0 242 255 515	WR 3 BC 0	0,6
Super 9 AC	01.99-12.05	1	0 242 255 515	WR 3 BC 0	0,6
Super 9 LC	01.99-12.05	1	0 242 255 515	WR 3 BC 0	0,6
Tomos 50	01.01→	1	0 241 235 607	W 7 AC	0,6
Top Boy 50	01.97-12.07	1	0 242 255 515	WR 3 BC 0	0,6
Vitality 50 2T	01.04→	1	0 242 255 515	WR 3 BC 0	0,6
Vitality 50 4T	01.04→	1	0 242 065 501	UR 09 AC	0,5
Yager 50	01.00→	1	0 242 255 515	WR 3 BC 0	0,6
Yup 50	01.00→	1	0 242 255 515	WR 3 BC 0	0,6
ZX 50 Fever	01.98-12.04	1	0 242 255 515	WR 3 BC 0	
100 cc					
Cobra 100 Cross	01.95-12.05	1	0 242 245 577	WR 5 BC 0	
Cobra 100 Racer	01.95-12.05	1	0 242 255 515	WR 3 BC 0	0,6
125 cc					
Agility 125	01.05→	1	0 242 065 501	UR 09 AC	0,7
Calypto 125	01.97-12.08	1	0 241 056 502	U 3 AC	0,6
Cruiser 125	01.03→	1	0 242 150 507	XR 4 CC	0,7
Heroism 125	01.95-12.03	1	0 241 056 502	U 3 AC	0,7
Movie XL 125	01.02-12.05	1	0 241 056 502	U 3 AC	0,6
People 125	01.05→	1	0 241 056 502	U 3 AC	0,6
Vivio 125	01.00-12.03	1	0 242 065 501	UR 09 AC	
Zing II 125	01.08→	1	0 242 065 500	UR 09 CC	0,7
Zing 125	01.95-12.03	1	0 242 150 507	XR 4 CC	0,6
150 cc					
Heroism 150	01.95-12.03	1	0 241 056 502	U 3 AC	0,7
Movie 150	01.02-12.05	1	0 242 065 501	UR 09 AC	
200 cc					
People S 200I	01.07→	1	0 242 065 501	UR 09 AC	0,6
500 cc					
Xciting 500	01.04→	1	0 242 065 500	UR 09 CC	0,7

K-ZWO

50 cc					
Cat 50	01.97→	1	0 242 245 517	WR 5 AC	0,6
Sting 50	01.97→	1	0 242 245 517	WR 5 AC	0,5
Thunder 50	01.97→	1	0 242 245 517	WR 5 AC	0,5
Viva	01.97→	1	0 242 245 517	WR 5 AC	0,5
125 cc					
Appache 125	01.96→	1	0 241 150 504	X 4 CC	0,6
Royal 125	01.96→	1	0 241 056 502	U 3 AC	0,6





LAMBRETTA

200 cc						
Amiga 200	01.90-07.90	1	0 241 235 089	W 7 CC		0,5

LECSON

50 cc						
LTS 50 BW	01.96-12.00	1	0 241 235 754	W 7 BC		0,6
LTS 50 TR	01.95-12.00	1	0 241 235 754	W 7 BC		0,6

LEM MOTOR

50 cc						
Flash 50	01.94-12.99	1	0 242 245 517	WR 5 AC		0,6
Ghibli 50	01.90-12.95	1	0 242 245 517	WR 5 AC		0,6

LIFAN

50 cc						
LF 50 QT	01.04→	1	0 241 056 502	U 3 AC		0,6
150 cc						
LF 150 T	01.06→	1	0 241 056 502	U 3 AC		0,6

LML

200 cc						
NV SPL 200	01.95-12.04	1	0 241 229 579	W 8 CC		0,6

LONGJIA

50 cc						
Alien 50 Xooter	01.08→	1	0 242 245 517	WR 5 AC		0,7
125 cc						
Alien 125 Xooter	01.03→	1	0 242 065 501	UR 09 AC		0,7

MALAGUTI

50 cc						
Centro	01.93-12.99	1	0 242 245 517	WR 5 AC		0,6
	01.00-12.03	1	0 242 260 500	WR 2 AC		0,5
Ciak 50	01.98-12.08	1	0 242 260 500	WR 2 AC		0,5
Crosser	01.97-12.02	1	0 242 235 665	WR 7 BC+		0,6
CR1 50	01.96→	1	0 242 235 665	WR 7 BC+		0,5
ET Street 50	01.95-12.05	1	0 241 235 607	W 7 AC		0,6
F-10 Jetline	01.93-12.99	1	0 242 245 517	WR 5 AC		0,5
	01.00→	1	0 242 260 500	WR 2 AC		0,5
F-10 Jetline WAP	01.03→	1	0 242 245 517	WR 5 AC		0,6



F-12 Phantom	01.96-12.06	1	0 242 245 517	WR 5 AC	
F-12 Phantom AC	01.95-12.99	1	0 242 245 517	WR 5 AC	0,5
	01.00-12.02	1	0 242 260 500	WR 2 AC	0,5
	01.03→	1	0 242 245 517	WR 5 AC	0,5
F-12 Phantom GP	01.00→	1	0 242 260 500	WR 2 AC	0,5
F-12 Phantom LC DD	01.00→	1	0 242 260 500	WR 2 AC	0,5
F-15	01.96-12.08	1	0 242 260 500	WR 2 AC	0,5
Phantom LC Tiger 50	01.93→	1	0 242 245 517	WR 5 AC	0,6
Yesterday	01.97-12.01	1	0 242 260 500	WR 2 AC	0,6
70 cc					
F-15 Firefox RR	01.98-12.05	1	0 242 260 500	WR 2 AC	
F-69 Phantom	01.97-12.00	1	0 242 245 517	WR 5 AC	
125 cc					
Ciak 125	01.98-12.08	1	0 242 065 501	UR 09 AC	0,7
F-18 Warrior 125	01.00-12.05	1	0 242 065 501	UR 09 AC	
Madison 125	01.99-12.05	1	0 242 065 500	UR 09 CC	0,7
150 cc					
Ciak 150	01.00→	1	0 242 065 501	UR 09 AC	0,7
F-18 Warrior 150	01.00-12.05	1	0 242 065 501	UR 09 AC	
Madison K 150	01.99→	1	0 242 065 500	UR 09 CC	
200 cc					
Madison S 200	01.03→	1	0 242 065 500	UR 09 CC	0,6
250 cc					
F-12 Phantom Max 250	01.04→	1	0 242 065 500	UR 09 CC	0,6
Madison S 250	01.99-12.02	1	0 242 150 507	XR 4 CC	0,7
400 cc					
Madison K 400	01.02→	1	0 242 068 500	UR 08 CC	0,7

MARS

50 cc					
MK 50 1	01.93-12.99	1	0 241 235 754	W 7 BC	0,6

MBK

50 cc					
Active	01.87-12.95	1	0 242 240 561	WR 6 BC	0,7
		1	0 242 245 517	WR 5 AC	0,6
Booster NG 50	01.97→	1	0 242 260 500	WR 2 AC	0,6
Booster R 50	01.97→	1	0 242 245 517	WR 5 AC	0,6
Booster Rocket	01.96-12.05	1	0 242 260 500	WR 2 AC	0,6
Booster Spirit 50	01.96→	1	0 242 260 500	WR 2 AC	0,6
Booster Track 50	01.97-12.99	1	0 242 260 500	WR 2 AC	0,6
Booster 50	01.90-12.94	1	0 242 240 561	WR 6 BC	0,6
	01.93-12.96	1	0 242 245 517	WR 5 AC	0,5
	01.97→	1	0 242 260 500	WR 2 AC	0,6
Dakota 50	01.05→	1	0 242 245 517	WR 5 AC	0,6
Evolis	01.92→	1	0 242 235 533	WR 7 AC	0,5
		1	0 242 245 517	WR 5 AC	0,5
		1	0 242 260 500	WR 2 AC	0,6
Fizz	01.94→	1	0 242 245 517	WR 5 AC	0,6
		1	0 242 260 500	WR 2 AC	0,5
Flipper	01.96-12.06	1	0 242 260 500	WR 2 AC	0,6





Zyl.



Typ



◀ MBK

Forte 50	01.94→	1	0 242 245 517	WR 5 AC	0,6
	01.96→	1	0 242 260 500	WR 2 AC	0,6
Kansas 50	01.05→	1	0 242 245 517	WR 5 AC	0,6
Mach-G	01.00→	1	0 242 260 500	WR 2 AC	0,6
New Sorriso 50	01.95→	1	0 241 245 656	W 5 BC	0,6
Nitro 50	01.97→	1	0 242 260 500	WR 2 AC	0,6
Ovetto 50	01.97→	1	0 242 260 500	WR 2 AC	0,6
Phoenix 50	01.05→	1	0 242 245 517	WR 5 AC	0,6
Sorriso 50	01.03→	1	0 241 245 656	W 5 BC	0,6
Stunt 50	01.02→	1	0 242 260 500	WR 2 AC	0,6
Target 50	01.92→	1	0 241 245 656	W 5 BC	0,6
100 cc					
Nitro 100	01.00-12.05	1	0 242 260 500	WR 2 AC	0,6
Ovetto 100	01.97-12.05	1	0 242 260 500	WR 2 AC	0,6
125 cc					
Doodo 125	01.00-12.03	1	0 242 065 500	UR 09 CC	0,7
Flame	01.94-12.94	1	0 242 055 501	UR 3 AC	0,7
		1	0 242 060 501	UR 2 CC	0,6
		1	0 242 060 501	UR 2 CC	0,6
Skyliner 125	01.98→	1	0 242 065 500	UR 09 CC	0,7
Thunder 125	01.01-12.03	1	0 242 065 500	UR 09 CC	0,7
150 cc					
Thunder 150	01.01-12.02	1	0 242 065 500	UR 09 CC	0,7
Vertex 150	01.97→	1	0 242 060 501	UR 2 CC	0,7
180 cc					
Skyliner 180	01.03→	1	0 242 065 500	UR 09 CC	0,7
265 cc					
Kilibre 300	01.03-12.05	1	0 242 150 507	XR 4 CC	0,9
400 cc					
Skyliner 400	01.04→	1	0 242 060 501	UR 2 CC	0,7

MOTRON**50 cc**

Spike 50	01.98→	1	0 242 245 517	WR 5 AC	0,6
Sting 50	01.96→	1	0 242 245 517	WR 5 AC	0,6
Syncro 50	01.98→	1	0 242 245 517	WR 5 AC	0,6
Thunder 50	01.96→	1	0 242 245 517	WR 5 AC	0,6

MSA**50 cc**

MX 50	01.98-12.10	1	0 242 255 515	WR 3 BC 0	0,5
RC 50	01.99-12.10	1	0 242 250 503	WR 4 CC	0,6
RSE 50	01.99-12.10	1	0 242 250 503	WR 4 CC	0,6
RTW 50	01.00-12.10	1	0 242 250 503	WR 4 CC	0,6
SM 50	01.01-12.10	1	0 242 250 503	WR 4 CC	0,6



Typ



MZ (MOTORRADWERKE ZSCHOPAU)

50 cc

Moskito FB / SX 50	01.97-12.05	1	0 242 245 517	WR 5 AC	0,6
Moskito 50 RX	01.01→	1	0 242 235 665	WR 7 BC+	0,6
		1	0 242 255 515	WR 3 BC 0	0,6

125 cc

Cup replica 125	01.05→	1	0 242 065 500	UR 09 CC	0,6
Moskito 125	01.01-12.05	1	0 242 065 501	UR 09 AC	0,6

PEGASUS

50 cc

Corona 25	01.02-12.10	1	0 242 240 561	WR 6 BC	0,5
Corona 50	01.02-12.10	1	0 242 240 561	WR 6 BC	0,5
Skipper 25	01.00-12.02	1	0 242 240 561	WR 6 BC	0,5
Skipper 50	01.00-12.02	1	0 242 240 561	WR 6 BC	0,5
Sky 25	01.00-12.08	1	0 242 240 561	WR 6 BC	0,5
Sky 50	01.00-12.09	1	0 242 240 561	WR 6 BC	0,5
Solero 25	01.00-12.01	1	0 242 240 561	WR 6 BC	0,5
Solero 50	01.00-12.01	1	0 242 240 561	WR 6 BC	0,5

125 cc

Corona 125	01.02-12.10	1	0 242 065 501	UR 09 AC	0,6
Skipper 125	01.00-01.02	1	0 242 065 501	UR 09 AC	0,7
Sky 125	01.00-01.04	1	0 242 065 501	UR 09 AC	0,7

PEUGEOT

50 cc

Buxy 50	09.95-12.97	1	0 241 245 580	W 5 AC	0,6
Elyseo 50	01.98-12.02	1	0 242 245 517	WR 5 AC	0,7
Elystar Advantage 50	01.04→	1	0 242 245 517	WR 5 AC	0,7
Jet Force C-Tech 50	01.05→	1	0 242 060 501	UR 2 CC	0,6
Looxor TSDI 50	01.01→	1	0 242 055 509	UR 3 DC	0,6
Looxor 50	01.01→	1	0 242 245 517	WR 5 AC	0,6
Ludix 50	01.04→	1	0 242 245 517	WR 5 AC	0,6
Metal-X 50	01.01-12.02	1	0 242 245 517	WR 5 AC	0,6
SC 50 L	01.87-12.97	1	0 241 235 607	W 7 AC	0,5
		1	0 242 235 665	WR 7 BC+	0,6
Speedake	01.95-12.97	1	0 241 245 580	W 5 AC	0,6
Speedfight I 50	09.96-12.00	1	0 242 245 517	WR 5 AC	0,7
Speedfight II 50	01.01→	1	0 242 245 517	WR 5 AC	0,7
Squab 50	09.95-12.97	1	0 242 260 500	WR 2 AC	0,5
ST 50 / L (2) / Rapido	01.87-12.97	1	0 241 245 580	W 5 AC	0,5
		1	0 242 245 577	WR 5 BC 0	0,6
SV 50	01.93-12.95	1	0 241 256 512	W 3 AC	0,6
	01.96-12.97	1	0 242 260 500	WR 2 AC	0,6
SV 50 Geo	01.91-12.97	1	0 241 256 512	W 3 AC	0,6
SV 50 Junior	01.93-12.97	1	0 241 256 512	W 3 AC	0,6
Trekker TKR 50 Offroad	01.98-12.02	1	0 242 245 517	WR 5 AC	0,6
		1	0 242 260 500	WR 2 AC	0,6



◀ PEUGEOT

Trekker TKR 50 Road	01.98-12.02	1	0 242 245 517	WR 5 AC	0,6
		1	0 242 260 500	WR 2 AC	0,6
V-Clic 50	01.07→	1	0 242 065 501	UR 09 AC	0,6
Vivacity 50	01.99→	1	0 242 245 517	WR 5 AC	0,7
Zenith 50	01.95-12.00	1	0 241 245 580	W 5 AC	0,5
		1	0 242 260 500	WR 2 AC	0,5
80 cc					
Scooter SC 80 L-D	06.82-06.92	1	0 242 235 665	WR 7 BC+	0,7
SV 80	01.92-12.02	1	0 241 256 512	W 3 AC	0,6
100 cc					
Elyseo 100	01.98-12.03	1	0 242 250 503	WR 4 CC	0,7
Looxor 100	01.01-12.01	1	0 242 250 503	WR 4 CC	0,6
Speedfight 2 100	01.00→	1	0 242 250 503	WR 4 CC	0,6
Speedfight 100	01.97-12.02	1	0 242 250 503	WR 4 CC	0,6
SV 100	01.97-12.03	1	0 242 250 503	WR 4 CC	0,6
Trekker TKR 100	01.97-12.01	1	0 242 250 503	WR 4 CC	0,6
Vivacity 100	01.99-12.06	1	0 242 250 503	WR 4 CC	0,7
125 cc					
Elyseo / Advantage 125	01.98→	1	0 242 065 500	UR 09 CC	0,7
Elystar / Advantage 125	01.03→	1	0 242 060 501	UR 2 CC	0,7
Geopolis 125	01.06→	1	0 242 068 500	UR 08 CC	0,6
Jet Force 125 /ABS	03.03→	1	0 242 068 500	UR 08 CC	0,6
Looxor 125	01.03→	1	0 242 060 501	UR 2 CC	0,7
Ludix 125	01.04→	1	0 242 068 500	UR 08 CC	0,6
Satelis RS 125	01.08→	1	0 242 065 500	UR 09 CC	0,7
Satelis 125	01.06→	1	0 242 068 500	UR 08 CC	0,6
150 cc					
Elyseo 150	01.01-12.03	1	0 242 065 500	UR 09 CC	0,7
Elystar 150	01.03-12.07	1	0 242 060 501	UR 2 CC	0,7
Looxor 150	01.03-12.06	1	0 242 060 501	UR 2 CC	0,7
250 cc					
Geopolis 250	01.06→	1	0 242 068 500	UR 08 CC	0,6
Satelis 250	01.06→	1	0 242 068 500	UR 08 CC	0,6



PGO

50 cc					
Comet 50 Junior	01.93-12.05	1	0 241 245 656	W 5 BC	
Comet 50-2	01.93-12.98	1	0 241 245 656	W 5 BC	
90 cc					
Big Max 90	01.97→	1	0 242 240 561	WR 6 BC	0,5
Galaxy 90	01.94→	1	0 242 240 561	WR 6 BC	0,6
100 cc					
PM-S 110	01.96-12.06	1	0 241 245 656	W 5 BC	
PM-X 110	01.96-12.06	1	0 241 245 656	W 5 BC	
125 cc					
G-Max 125	01.03→	1	0 241 056 502	U 3 AC	0,7
Tornado 125	01.97→	1	0 242 240 561	WR 6 BC	0,5
T-Rex 125 2T	01.99-12.05	1	0 241 245 656	W 5 BC	0,6
T-Rex 125 4T	01.99-12.05	1	0 241 056 502	U 3 AC	0,6
150 cc					
T-Rex 150 4T	01.99→	1	0 241 056 502	U 3 AC	0,6



Typ



PIAGGIO

50 cc

BOSS	01.88-12.89	1	0 241 235 607	W 7 AC	0,5
Diesis 50	01.01-12.05	1	0 242 255 502	WR 3 CC	0,7
Free 50 Kat	01.93-12.99	1	0 242 255 502	WR 3 CC	0,7
Liberty 50 2T	01.97→	1	0 242 255 502	WR 3 CC	0,7
Liberty 50 4T	01.00→	1	0 242 065 500	UR 09 CC	0,7
NRG mc3 50	01.96-12.00	1	0 241 256 515	W 3 CS	0,6
NRG mc3 AC	01.01-12.04	1	0 242 255 502	WR 3 CC	
NRG mc3 DD 50 Power	01.05-12.06	1	0 242 265 500	WR 09 CC	
	01.07-12.11	1	0 242 250 503	WR 4 CC	
NRG mc3 DD 50 Purejet	01.02-12.04	1	0 242 055 509	UR 3 DC	0,6
NRG mc3 DT 50 Power	01.05-12.11	1	0 242 255 502	WR 3 CC	0,6
NRG mc3 LC	01.01-12.04	1	0 242 265 500	WR 09 CC	
NRG 50 Power Purejet	01.04-12.11	1	0 242 055 509	UR 3 DC	0,8
NSP 4T	01.02-12.10	1	0 242 068 500	UR 08 CC	0,8
Skipper 50	01.98-12.00	1	0 242 255 502	WR 3 CC	0,6
Vespa LX 50 2T	01.05→	1	0 242 255 502	WR 3 CC	0,7
Vespa LX 50 4T	01.05→	1	0 242 065 500	UR 09 CC	
Vespa LXV 50	01.06-12.08	1	0 242 255 502	WR 3 CC	
Vespa PK 50 / S	09.82-12.87	1	0 241 235 607	W 7 AC	0,5
Vespa PK 50 S Automatic	01.84-12.85	1	0 242 245 521	WR 5 CC	0,5
Vespa PK 50 SS / SE Elestar	01.83-12.87	1	0 241 245 580	W 5 AC	0,5
Vespa PK 50 XL	01.86-12.94	1	0 242 245 517	WR 5 AC	0,5
Vespa PK 50 XL Cup	01.90-12.99	1	0 241 248 538	W 4 CC	0,5
		1	0 241 256 515	W 3 CS	0,5
Vespa PK 50 XL Plurimatic	01.86-12.95	1	0 241 235 607	W 7 AC	0,5
Vespa PK 50 XL Puch	01.90-12.99	1	0 241 248 538	W 4 CC	0,5
		1	0 241 256 515	W 3 CS	0,5
Vespa PK 50 XL 2	01.90-12.97	1	0 242 245 517	WR 5 AC	0,6
Vespa PK 50 XL 2 Automatic	01.90-12.97	1	0 241 248 538	W 4 CC	0,5
Vespa PKS 50	09.82-12.85	1	0 242 245 517	WR 5 AC	0,5
Vespa S 50 2T	01.07→	1	0 242 250 503	WR 4 CC	
Vespa 50 Bravo P	01.82-12.95	1	0 242 235 533	WR 7 AC	0,7
Vespa 50 Ciao P Lusso	01.95-12.99	1	0 242 235 533	WR 7 AC	0,7
Vespa 50 Ciao PV	03.81-12.95	1	0 242 235 533	WR 7 AC	0,7
Vespa 50 Ciao PX	03.81-12.95	1	0 241 235 607	W 7 AC	0,5
Vespa 50 Ciao PX Lusso	03.96-12.99	1	0 242 235 533	WR 7 AC	0,7
Vespa 50 ET2	01.97-12.05	1	0 242 255 502	WR 3 CC	0,6
Vespa 50 ET4	01.02-12.05	1	0 242 068 500	UR 08 CC	0,8
Vespa 50 Grillo	01.89-12.96	1	0 241 229 604	W 8 AC	0,5
Vespa 50 HP	01.91-12.99	1	0 241 245 580	W 5 AC	0,5
Vespa 50 N Speedmatic	01.90-12.99	1	0 241 248 538	W 4 CC	0,5
		1	0 241 256 515	W 3 CS	0,5
Vespa 50 Rush	09.88-12.99	1	0 242 245 517	WR 5 AC	0,6
Vespa 50 Super Bravo	01.85-12.94	1	0 241 229 604	W 8 AC	0,5
Vespa 50 Super Bravo 2	01.86-12.95	1	0 241 229 604	W 8 AC	0,5
Vespa 50 Vespino	03.81-12.97	1	0 242 245 517	WR 5 AC	0,6
Zip & Zip 50 4T Aria	01.02→	1	0 242 068 500	UR 08 CC	0,8
Zip Air	01.96-12.00	1	0 242 255 502	WR 3 CC	0,7
Zip 50 SP	01.01-12.05	1	0 242 265 500	WR 09 CC	
	01.06→	1	0 242 250 503	WR 4 CC	



◀ PIAGGIO

Zip 50 2T	01.08→	1	0 242 250 503	WR 4 CC	
Zip 50 4T	01.00→	1	0 242 065 500	UR 09 CC	0,6
75 cc					
SKR City	01.99→	1	0 242 255 502	WR 3 CC	0,6
Vespa PK 75 S / Primavera	01.76→	1	0 241 245 580	W 5 AC	0,5
80 cc					
PK 80 S	01.83-12.88	1	0 242 245 517	WR 5 AC	0,6
Typhoon 80	01.95→	1	0 242 255 502	WR 3 CC	0,6
Vespa PK 80 S	09.82-12.85	1	0 242 245 517	WR 5 AC	
Vespa PX 80	12.81-12.91	1	0 241 245 581	W 5 CC	0,5
100 cc					
Diesis 100	01.01-12.05	1	0 242 065 500	UR 09 CC	0,6
Fly 100	01.06→	1	0 242 068 500	UR 08 CC	0,7
Free 100	01.02→	1	0 242 065 500	UR 09 CC	0,6
Vespa PK 100 S	06.82-12.92	1	0 242 245 517	WR 5 AC	0,6
Vespa 100	01.78-01.83	1	0 242 245 517	WR 5 AC	0,5
Zip 100	01.06→	1	0 242 068 500	UR 08 CC	0,7
125 cc					
Beverly 125	01.01-12.10	1	0 242 065 500	UR 09 CC	0,6
Carnaby 125	01.07-12.10	1	0 242 065 500	UR 09 CC	0,6
Cosa 125	01.88-12.90	1	0 241 248 538	W 4 CC	0,5
Fly 125	01.04→	1	0 242 060 501	UR 2 CC	0,6
Fly 125 ie	01.12→	1	0 242 065 500	UR 09 CC	
Hexagon LX 4T 125	01.98-12.05	1	0 242 060 501	UR 2 CC	0,6
Hexagon 125 GTX	01.00-12.00	1	0 242 065 500	UR 09 CC	0,6
Liberty 125	01.98-12.00	1	0 242 068 500	UR 08 CC	0,6
	01.01-12.02	1	0 242 065 500	UR 09 CC	0,6
Liberty 125 ie	01.12→	1	0 242 065 500	UR 09 CC	
Liberty 125 4T	01.01→	1	0 242 060 501	UR 2 CC	0,6
MP3 125	01.06-12.09	1	0 242 065 500	UR 09 CC	0,6
MP3 125 IE	01.08→	1	0 242 065 500	UR 09 CC	
Sfera 125	10.95-12.98	1	0 242 068 500	UR 08 CC	0,6
Sfera 125 RST	01.95-12.98	1	0 242 060 501	UR 2 CC	0,6
Skipper 125 2T	01.00-12.05	1	0 242 065 500	UR 09 CC	
Skipper 125 4T	01.00-12.02	1	0 242 065 500	UR 09 CC	
Super Hexagon GTX 125	01.01-12.05	1	0 242 065 500	UR 09 CC	0,6
Vespa Granturismo 125	01.03-12.07	1	0 242 065 500	UR 09 CC	0,6
Vespa GTS 125	01.07-12.11	1	0 242 065 500	UR 09 CC	
Vespa GTV 125	01.07-12.09	1	0 242 065 500	UR 09 CC	
Vespa LX 125	01.05-12.09	1	0 242 060 501	UR 2 CC	0,6
Vespa LX 125 ie	01.09→	1	0 242 065 500	UR 09 CC	
Vespa LX 125 3v ie	01.12→	1	0 242 065 500	UR 09 CC	
Vespa LXV 125	01.06-12.09	1	0 242 060 501	UR 2 CC	0,6
Vespa LXV 125 ie	01.10→	1	0 242 065 500	UR 09 CC	
Vespa P 125 ETS	01.83-12.85	1	0 242 245 517	WR 5 AC	0,6
Vespa P 125 X	01.77-12.81	1	0 242 235 533	WR 7 AC	0,5
Vespa PK 125	09.82-12.87	1	0 242 245 517	WR 5 AC	0,6
Vespa PK 125 E Arc AE	01.84-12.93	1	0 242 245 517	WR 5 AC	0,5
Vespa PK 125 S	09.82-12.87	1	0 242 235 533	WR 7 AC	0,5
Vespa PK 125 S Automatic	01.84-12.87	1	0 241 245 580	W 5 AC	0,5
Vespa PK 125 XL Automatik	01.91-12.01	1	0 242 245 517	WR 5 AC	0,6
Vespa PK 125 XL 2	01.86-12.95	1	0 241 248 538	W 4 CC	0,5
Vespa PX 125	01.98-12.01	1	0 241 235 607	W 7 AC	0,5
	01.01-12.08	1	0 242 245 517	WR 5 AC	
	01.11→	1	0 242 245 517	WR 5 AC	





Vespa PX 125 E	01.82-12.91	1	0 241 235 607	W 7 AC	0,5	
Vespa PX 125 E Lusso	01.82-12.94	1	0 241 235 607	W 7 AC	0,5	
Vespa S 125	01.07-12.09	1	0 242 060 501	UR 2 CC		
Vespa S 125 ie	01.09-12.12	1	0 242 065 500	UR 09 CC		
Vespa S 125 ie 3v	01.12→	1	0 242 065 500	UR 09 CC		
Vespa spracial ET 3 Primavera	01.76-12.83	1	0 241 245 580	W 5 AC	0,6	
Vespa 125 CI	01.88-12.93	1	0 241 235 607	W 7 AC	0,5	
Vespa 125 Cosa AE	01.88-12.90	1	0 241 248 538	W 4 CC	0,5	
		1	0 241 256 515	W 3 CS	0,5	
Vespa 125 ET 4	01.96-12.04	1	0 242 065 500	UR 09 CC	0,7	
Vespa 125 FL2	01.90-12.99	1	0 241 245 580	W 5 AC	0,6	
Vespa 125 LS	01.88-12.93	1	0 241 235 607	W 7 AC	0,5	
Vespa 125 NK Primavera	01.88-12.93	1	0 241 235 607	W 7 AC	0,5	
Vespa 125 Primavera, ET 3	01.76-12.83	1	0 242 245 517	WR 5 AC	0,6	
Vespa 125 T5	03.85-12.00	1	0 241 248 538	W 4 CC	0,6	
XEvo 125	01.07→	1	0 242 065 500	UR 09 CC	0,6	
X7 125	01.07-12.08	1	0 242 055 508	UHR 3 CC	0,9	
		1	0 242 065 500	UR 09 CC	0,6	
X8 125	01.04-12.07	1	0 242 065 500	UR 09 CC	0,6	
X9 125	01.01-12.08	1	0 242 065 500	UR 09 CC	0,6	
Zip 125	01.00-12.05	1	0 242 068 500	UR 08 CC	0,6	
150 cc						
Liberty 150	01.01-12.02	1	0 242 065 500	UR 09 CC		
	01.08-12.12	1	0 242 060 501	UR 2 CC		
Liberty 150 LE	01.03-12.05	1	0 242 060 501	UR 2 CC	0,6	
Skipper SKR 150 ST	01.00→	1	0 242 255 502	WR 3 CC	0,7	
Vespa P 150 S	01.82-12.87	1	0 242 245 517	WR 5 AC	0,5	
Vespa P 150 X	01.78-12.81	1	0 242 245 517	WR 5 AC	0,5	
Vespa PX 150	01.11→	1	0 242 245 517	WR 5 AC		
Vespa PX 150 E	01.82-12.93	1	0 241 235 607	W 7 AC	0,6	
Vespa PX 150 E Lusso	01.88-12.93	1	0 241 235 607	W 7 AC	0,5	
Vespa PX 150 kat	01.05-12.06	1	0 242 235 533	WR 7 AC	0,7	
Vespa 150 Cosa	01.88-12.97	1	0 242 255 502	WR 3 CC	0,6	
Vespa 150 ET 4	01.00-12.01	1	0 242 060 501	UR 2 CC	0,6	
	01.02-12.02	1	0 242 065 500	UR 09 CC	0,6	
	01.03-12.05	1	0 242 060 501	UR 2 CC	0,8	
180 cc						
Super Hexagon GTX 180	01.01-12.05	1	0 242 065 500	UR 09 CC	0,6	
X9 180	01.00-12.03	1	0 242 065 500	UR 09 CC	0,6	
200 cc						
Beverly 200	01.01-12.08	1	0 242 065 500	UR 09 CC	0,6	
Carnaby 200	01.06-12.08	1	0 242 065 500	UR 09 CC	0,6	
Liberty 200	01.04-12.08	1	0 242 060 501	UR 2 CC	0,8	
Vespa P 200 E	01.77-12.81	1	0 241 245 581	W 5 CC	0,5	
Vespa PX 200 E Grand Sport	01.84-12.99	1	0 242 245 521	WR 5 CC	0,5	
Vespa PX 200 E Lusso	01.84-12.87	1	0 242 245 521	WR 5 CC	0,5	
Vespa 200 Cosa	01.88-12.98	1	0 242 250 503	WR 4 CC	0,6	
Vespa 200 Cosa FL/ Elestart	01.91-12.96	1	0 242 250 503	WR 4 CC	0,6	
Vespa 200 DN	12.79-01.81	1	0 242 245 521	WR 5 CC	0,5	
Vespa 200 DS	12.79-01.81	1	0 242 245 521	WR 5 CC	0,5	
250 cc						
Beverly 250	01.03-12.07	1	0 242 060 501	UR 2 CC	0,6	
MP3 250	01.06-12.08	1	0 242 065 500	UR 09 CC	0,6	
Super Hexagon GTX 250	01.00-12.02	1	0 242 068 500	UR 08 CC	0,7	
Vespa GTS 250	01.05→	ABS	1	0 242 065 500	UR 09 CC	0,6



◀ PIAGGIO

XEvo 250	01.07-12.11	1	0 242 065 500	UR 09 CC	0,6
X7 250	01.08-12.09	1	0 242 065 500	UR 09 CC	0,6
X8 250	01.05-12.08	1	0 242 065 500	UR 09 CC	0,6
X9 Evolution 250	01.04-12.06	1	0 242 065 500	UR 09 CC	0,6
300 cc					
X7 300	01.09-12.12	1	0 242 065 500	UR 09 CC	0,6

PUCH (STEYR-DAIMLER-PUCH AG)

50 cc					
Lido 50	01.84-12.98	1	0 242 235 665	WR 7 BC+	0,7
125 cc					
Lido 125	01.84-12.98	1	0 242 160 503	XR 2 CE 0	0,7

RENAULT SPORT

50 cc					
Campus 50	01.01→	1	0 242 250 503	WR 4 CC	0,6
Specimen 50	01.01→	1	0 242 260 500	WR 2 AC	0,6
100 cc					
Specimen 100	01.01→	1	0 242 260 500	WR 2 AC	0,6
125 cc					
FullTime 125	01.01→	1	0 242 068 500	UR 08 CC	0,6
Groomy 125	01.01→	1	0 242 068 500	UR 08 CC	0,6
Kouranos 125	01.01→	1	0 242 068 500	UR 08 CC	0,6

REX

50 cc					
Rex	01.96→	1	0 242 240 561	WR 6 BC	0,6
Rexy	01.96→	1	0 242 240 561	WR 6 BC	0,6
Scooter	01.96→	1	0 242 240 561	WR 6 BC	0,6
Silver Star	01.00→	1	0 242 240 561	WR 6 BC	0,6
Silver Street	01.99→	1	0 242 240 561	WR 6 BC	0,6

RIVERO

50 cc					
Linus 50	01.04-12.07	1	0 242 240 561	WR 6 BC	0,5
125 cc					
Phoenix 125	01.06-12.09	1	0 242 060 506	UR 2 AC	0,6

SACHS (FICHTEL & SACHS AG)

50 cc					
Buxy RS	01.96-12.97	1	0 241 245 580	W 5 AC	0,6
City Roller CV 50	01.92-12.00	1	0 242 235 665	WR 7 BC+	0,7
Limbo 50	01.95-12.04	1	0 241 235 754	W 7 BC	0,6
MadAss 50	01.04→	1	0 242 065 501	UR 09 AC	0,8
Reggae	01.94-12.00	1	0 241 245 580	W 5 AC	0,6



Typ



SAMBA SR	01.92-12.04	1	0 241 256 512	W 3 AC	0,5
Speedake	01.94-12.04	1	0 241 245 580	W 5 AC	0,6
Speedfight 50	01.97-12.04	1	0 242 245 517	WR 5 AC	0,6
Splinter	01.96-12.04	1	0 241 245 580	W 5 AC	0,6
Squab	01.96-12.04	1	0 242 260 500	WR 2 AC	0,6
SR 50	01.95-12.97	1	0 241 256 512	W 3 AC	0,6
SV 50	01.95→	1	0 241 256 512	W 3 AC	0,6
49er	01.05→	1	0 242 065 501	UR 09 AC	0,5
80 cc					
SR 80	01.94-12.04	1	0 241 256 512	W 3 AC	0,6
125 cc					
SR 125	01.95-12.04	1	0 241 235 754	W 7 BC	0,6
Superduke	01.97→	1	0 241 056 502	U 3 AC	0,6
SV 125	01.92→	1	0 241 235 754	W 7 BC	0,6

SASY

50 cc					
Classic 200E	01.96→	1	0 242 235 665	WR 7 BC+	0,5
Jet 50	01.96→	1	0 242 235 665	WR 7 BC+	0,5
Mulan 50	01.96→	1	0 242 235 665	WR 7 BC+	0,5
Standard 50	01.96→	1	0 242 235 665	WR 7 BC+	0,5

SHE LUNG

50 cc					
Club 50	01.97-01.02	1	0 241 245 656	W 5 BC	0,6
Racer 50	01.96-01.01	1	0 241 245 656	W 5 BC	0,6

SIAM

50 cc					
Falcon 50	01.97→	1	0 242 245 517	WR 5 AC	0,6
Scross 50	01.94→	1	0 242 235 665	WR 7 BC+	0,6

SIAMOTO

25 cc					
Birdie 25	01.99-12.04	1	0 242 235 665	WR 7 BC+	0,6
50 cc					
Birdie 50	01.99-12.04	1	0 242 235 665	WR 7 BC+	0,6
Scross 50	01.99-12.04	1	0 242 245 517	WR 5 AC	0,5
125 cc					
Capri 125	01.99-12.04	1	0 241 056 502	U 3 AC	0,7
Favorite 125	01.99-12.04	1	0 241 056 502	U 3 AC	0,7
KD 125	01.99-12.04	1	0 241 056 502	U 3 AC	0,7



Zyl.



Typ

**SIMSON****50 cc**

City 2000	01.95-12.02	1	0 241 256 512	W 3 AC	0,6
Star Classic 50	08.96-12.02	1	0 241 256 512	W 3 AC	0,4
Star 25	08.96-12.02	1	0 241 256 512	W 3 AC	0,4
Star 50	08.96-12.02	1	0 242 235 665	WR 7 BC+	0,7

70 cc

SR 80	01.94-12.02	1	0 241 256 512	W 3 AC	0,6
Star Classic 80	01.96→	1	0 241 256 512	W 3 AC	0,4
	01.97→	1	0 241 260 507	W 2 AC	0,4

STEFFEN**50 cc**

Steffi 50	01.98-12.02	1	0 241 235 754	W 7 BC	0,6
-----------	-------------	---	---------------	--------	-----

STEYR (STEYR-DAIMLER-PUCH AG)**50 cc**

Lido Vario CB 50	01.88-12.98	1	0 242 235 665	WR 7 BC+	0,7
------------------	-------------	---	---------------	----------	-----

SUNDIRO**125 cc**

Phoenix XDZ 125T	01.96→	1	0 242 065 501	UR 09 AC	0,6
Phoenix XDZ 125TA	01.96→	1	0 242 065 501	UR 09 AC	0,6

SUZUKI**50 cc**

AH 50 / Adress / GP	01.92-12.96	1	0 242 235 665	WR 7 BC+	0,6
AJ 50 / Sepia / ZZ	01.95-12.01	1	0 242 240 561	WR 6 BC	0,6
AP 50	01.95-12.03	1	0 242 235 665	WR 7 BC+	0,7
AY 50 Katana	01.97-12.06	1	0 242 235 665	WR 7 BC+	0,6
AY 50 Katana Di-Tech	01.05→	1	0 242 055 509	UR 3 DC	0,6
AY 50 Katana water	01.97-12.06	1	0 242 240 561	WR 6 BC	0,7
CP 50	01.85-12.93	1	0 242 235 665	WR 7 BC+	0,7
UF 50 Estilete	01.00-12.01	1	0 242 240 561	WR 6 BC	0,6
UX 50 W Zillion	01.99-12.03	1	0 242 235 665	WR 7 BC+	0,7

75 cc

CP 75	01.87-12.87	1	0 242 235 665	WR 7 BC+	0,7
-------	-------------	---	---------------	----------	-----

80 cc

CP 80	01.85-12.93	1	0 242 235 665	WR 7 BC+	0,7
CS 80	01.83-12.93	1	0 242 235 665	WR 7 BC+	0,7

100 cc

Adress 100 / AG 100	01.94-12.03	1	0 242 240 561	WR 6 BC	0,7
AH 100 Adress	01.92-12.96	1	0 242 240 561	WR 6 BC	0,7

110 cc

UG 110 Hokuto	01.00-12.02	1	0 242 240 561	WR 6 BC	
---------------	-------------	---	---------------	---------	--



Typ



125 cc						
AN 125	01.95-12.96		1	0 242 065 500	UR 09 CC	0,7
	01.97-12.00		1	0 242 060 501	UR 2 CC	0,7
CS 125	01.83-12.93		1	0 242 150 507	XR 4 CC	0,7
FL 125 SDW	01.08-12.09		1	0 242 055 501	UR 3 AC	0,7
UC 125 Epicuro	01.99-12.01		1	0 242 065 500	UR 09 CC	0,7
UE 125	01.01-12.01		1	0 242 060 501	UR 2 CC	0,7
UH 125 Burgman	01.02→		1	0 242 065 500	UR 09 CC	0,7
UX Sixteen 125	01.08→		1	0 242 065 500	UR 09 CC	0,7
150 cc						
AN 150	01.96→		1	0 242 060 501	UR 2 CC	0,7
UC 150 Epicuro	01.99-12.01		1	0 242 065 500	UR 09 CC	
UE 150	01.01-12.01		1	0 242 060 501	UR 2 CC	
UH 150 Burgman	01.02-12.06		1	0 242 065 500	UR 09 CC	
UX 150 SIXteen	01.08-12.11		1	0 242 065 500	UR 09 CC	0,7
200 cc						
UH 200 Burgman	01.07→		1	0 242 060 505	UR 2 CDC	0,7
250 cc						
AN 250 Burgman	01.98-12.06		1	0 242 060 505	UR 2 CDC	
400 cc						
AN 400 Burgman	01.99→		1	0 242 060 501	UR 2 CC	0,7
650 cc						
AN 650 Burgman	01.03→		2	0 242 065 500	UR 09 CC	0,7

SYM



50 cc						
DD 50	01.02→		1	0 242 255 515	WR 3 BC 0	0,6
Dio 50	01.95→		1	0 242 255 515	WR 3 BC 0	0,6
Fancy 50	10.95→		1	0 242 255 515	WR 3 BC 0	0,6
Flash 50	01.96→		1	0 242 255 515	WR 3 BC 0	0,6
Free 50	01.96→		1	0 242 255 515	WR 3 BC 0	0,6
Jet SportX 50 R/ SR	01.06→		1	0 242 255 515	WR 3 BC 0	0,6
Mask 50	01.02→		1	0 242 255 515	WR 3 BC 0	0,6
Mio 50	01.04→		1	0 242 055 501	UR 3 AC	0,7
Pure 50	01.96→		1	0 242 255 515	WR 3 BC 0	0,6
Red Devil 50	01.00→		1	0 242 255 515	WR 3 BC 0	0,6
RS 50	01.05→		1	0 242 255 515	WR 3 BC 0	0,6
Shark 50	01.00→		1	0 242 255 515	WR 3 BC 0	0,6
Super Fancy	01.96→		1	0 242 255 515	WR 3 BC 0	0,6
125 cc						
Euro-MX 125	01.05→	XJB	1	0 242 065 501	UR 09 AC	0,6
		XJC	1	0 242 065 500	UR 09 CC	0,7
GTS 125	01.05→		1	0 242 065 500	UR 09 CC	0,7
HD 125	01.05→		1	0 242 065 500	UR 09 CC	0,7
RS 125	01.04→	XJB	1	0 242 065 501	UR 09 AC	0,6
		XJC	1	0 242 065 500	UR 09 CC	0,7
XS 125 K	01.05→		1	0 242 150 507	XR 4 CC	0,7
170 cc						
HD 200	01.05→		1	0 242 065 500	UR 09 CC	0,7
250 cc						
GTS 250	01.05→		1	0 242 065 500	UR 09 CC	0,7



Zyl.



Typ

**TGB****50 cc**

Bunny AS 50 X	01.94→	1	0 241 235 754	W 7 BC	0,6
KBX 50	01.94→	1	0 241 235 754	W 7 BC	0,6

TNG**50 cc**

Venice 49	01.07→	1	0 241 245 656	W 5 BC	0,7
125 cc					
Del Ray 125	01.03→	1	0 241 056 502	U 3 AC	0,7
Milano 125	01.03→	1	0 241 056 502	U 3 AC	0,7
150 cc					
Baja 150	01.07→	1	0 241 056 502	U 3 AC	0,6
Milano 150	01.07→	1	0 241 056 502	U 3 AC	0,7

TOKAIDO**50 cc**

K 50 2000	01.96→	1	0 242 245 517	WR 5 AC	0,6
SM 50	01.93→	1	0 241 245 656	W 5 BC	0,6
50 V	01.92→	1	0 241 245 656	W 5 BC	0,6

TOMOS**50 cc**

Forza 50	01.95-12.98	1	0 242 245 531	WR 5 BC	0,6
----------	-------------	---	---------------	---------	-----

VELOCIFERO**50 cc**

Velocifero 50	01.94-12.99	1	0 241 256 512	W 3 AC	0,6
---------------	-------------	---	---------------	--------	-----

VIVA**50 cc**

Viva 50	01.96-12.01	1	0 241 245 656	W 5 BC	0,5
---------	-------------	---	---------------	--------	-----

WINKING**50 cc**

Bunny AS 50	01.91-12.97	1	0 241 245 656	W 5 BC	0,7
Bunny AS 50 X	01.94-12.00	1	0 241 235 754	W 7 BC	0,7
Bunny AT 50	01.91-12.97	1	0 241 245 656	W 5 BC	0,7
Koala LM 50	01.93-12.99	1	0 241 235 607	W 7 AC	0,6
Scooty Roller 50	01.93-12.99	1	0 241 235 607	W 7 AC	0,6



Typ



WP

50 cc					
Wave 50	01.96-12.01	1	0 242 240 561	WR 6 BC	0,5

YAMAHA

50 cc					
Aerox 50	01.97→	1	0 242 260 500	WR 2 AC	0,6
Beluga 50	01.89-12.03	1	0 241 245 656	W 5 BC	1,0
Breeze 50	01.94→	1	0 242 245 517	WR 5 AC	0,6
BW's 50	01.90-12.95	1	0 242 245 517	WR 5 AC	0,7
	01.96→	1	0 242 260 500	WR 2 AC	0,7
BW's 50 Bump	01.96-12.99	1	0 242 260 500	WR 2 AC	0,7
BW's 50 NG	01.96→	1	0 242 260 500	WR 2 AC	0,7
BW's 50 R	01.96→	1	0 242 260 500	WR 2 AC	0,7
BW's 50 Spy	01.96-12.99	1	0 242 260 500	WR 2 AC	0,7
CA 50 M Salient	09.82-12.87	1	0 242 235 665	WR 7 BC+	0,7
CG 50 Jog	01.88-12.92	1	0 242 235 665	WR 7 BC+	0,7
CP 50	01.89-12.99	1	0 242 235 665	WR 7 BC+	0,7
CR 50	01.89-12.97	1	0 241 245 656	W 5 BC	1,0
		1	0 242 245 517	WR 5 AC	0,5
CT 50 S	01.90-12.95	1	0 241 245 656	W 5 BC	1,0
CT 50 SS	01.90-12.95	1	0 241 245 656	W 5 BC	0,7
CV 50 Jog	01.00-12.03	1	0 242 235 665	WR 7 BC+	0,7
CW 50	01.91-12.93	1	0 242 245 517	WR 5 AC	0,8
	01.94-12.95	1	0 242 240 561	WR 6 BC	0,7
	01.96-12.07	1	0 242 260 500	WR 2 AC	0,7
CY 50 F	01.94-12.97	1	0 242 240 561	WR 6 BC	0,7
CY 50 Jog	01.91-12.97	1	0 241 245 656	W 5 BC	0,7
EW 50 Slider	01.00-12.06	1	0 242 260 500	WR 2 AC	0,6
Fizz 50	01.94-12.95	1	0 242 260 500	WR 2 AC	0,7
Jog 50	01.02→	1	0 242 260 500	WR 2 AC	0,6
MBK 50 Magnum	01.90-12.95	1	0 241 248 538	W 4 CC	0,6
SH 50 Razz	01.87-12.92	1	0 242 235 665	WR 7 BC+	1,0
XF 50 Giggle	01.07→	1	0 242 060 501	UR 2 CC	0,6
YA 50 Axis	01.96→	1	0 242 245 517	WR 5 AC	0,7
YA 50 R	01.92→	1	0 242 260 500	WR 2 AC	0,7
YE 50 Evolis	01.92-12.95	1	0 242 245 517	WR 5 AC	0,7
YE 50 Zest	01.93-12.99	1	0 242 260 500	WR 2 AC	0,7
YH 50 Why	01.99→	1	0 242 260 500	WR 2 AC	0,6
YM 50 Breeze	01.95→	1	0 242 260 500	WR 2 AC	0,7
YN 50 F Neo's 4	01.09→	1	0 242 060 501	UR 2 CC	0,8
YN 50 Neo's	01.97→	1	0 242 260 500	WR 2 AC	0,6
60 cc					
CW 65	01.94-12.94	1	0 242 245 517	WR 5 AC	0,7
80 cc					
Active 80	01.90-12.00	1	0 242 240 561	WR 6 BC	0,7
CH 80 Beluga	01.90-12.92	1	0 242 245 517	WR 5 AC	0,7
CV 80 Beluga	01.81-12.86	1	0 242 240 561	WR 6 BC	0,7
T 80 Townmate	01.83-12.97	1	0 242 060 506	UR 2 AC	0,7
V 80	01.79-12.83	1	0 241 235 754	W 7 BC	0,7



◀ YAMAHA

Y 80	01.82-12.89	1	0 241 235 754	W 7 BC	0,7
YE 80	01.94-12.97	1	0 242 245 517	WR 5 AC	0,7
90 cc					
Jog 90	01.92-12.02	1	0 242 245 531	WR 5 BC	0,7
YA 90 Axis	01.91-12.98	1	0 242 245 517	WR 5 AC	0,7
100 cc					
BW's 100	01.99-12.01	1	0 242 245 517	WR 5 AC	0,7
YN 100 Neo's	01.99-12.03	1	0 242 260 500	WR 2 AC	0,6
YQ 100 Aerox	01.00-12.08	1	0 242 260 500	WR 2 AC	0,6
125 cc					
BL 125 Beluga	01.85-12.89	1	0 242 245 531	WR 5 BC	0,7
DooDo 125	01.01→	1	0 242 065 500	UR 09 CC	0,7
NXC 125 CygnusX	01.04→	1	0 242 060 501	UR 2 CC	0,7
Vity 125	01.08→	1	0 242 060 501	UR 2 CC	0,6
XC 125 Beluga	01.90-12.95	1	0 242 055 501	UR 3 AC	0,7
XC 125 Cygnus	01.94-12.03	1	0 242 060 501	UR 2 CC	0,7
X-City 125	01.08→	1	0 242 065 500	UR 09 CC	
XN 125 Teo's	01.00-12.03	1	0 242 065 500	UR 09 CC	0,7
XQ 125 Maxster	01.01-12.03	1	0 242 065 500	UR 09 CC	0,7
YP 125 Majesty	01.03→	1	0 242 065 500	UR 09 CC	0,7
YP 125 R Majesty	01.95-12.02	1	0 242 065 500	UR 09 CC	0,7
150 cc					
XC 150 Fly One	01.95-12.99	1	0 242 060 501	UR 2 CC	0,7
XN 150 Teo's	01.01-12.02	1	0 242 065 500	UR 09 CC	
XQ 150 Maxster	01.01-12.03	1	0 242 065 500	UR 09 CC	
YP 150 Majesty	01.99-12.04	1	0 242 065 500	UR 09 CC	
175 cc					
YP 180 Majesty	01.03-12.06	1	0 242 065 500	UR 09 CC	
250 cc					
X-Max 250	01.05-12.06	1	0 242 150 507	XR 4 CC	0,7
YP 250 Majesty	01.95-12.03	1	0 242 150 507	XR 4 CC	0,6
260 cc					
Versity 300	01.03-12.06	1	0 242 150 507	XR 4 CC	0,6
400 cc					
YP 400 Majesty	01.04→	1	0 242 060 501	UR 2 CC	0,7
500 cc					
T-Max 500	01.01-12.02	2	0 242 060 501	UR 2 CC	0,7
T-MAX 500	01.03-12.11	2	0 242 060 501	UR 2 CC	0,7

ZUENDAPP

50 cc					
Famel Yuppie 50	01.80-12.02	1	0 241 248 538	W 4 CC	0,6



ACCESS

50 cc					
Long 50	01.99→	1	0 242 255 515	WR 3 BC 0	0,8
Streak 50	01.99→	1	0 242 255 515	WR 3 BC 0	0,8
100 cc					
Long 100	01.99→	1	0 242 255 515	WR 3 BC 0	0,8

ADLY

50 cc					
ATV 50	01.04→	1	0 241 245 656	W 5 BC	0,6
ATV 50 RS Supersonic	01.05→	1	0 242 240 561	WR 6 BC	0,7
125 cc					
Buggy 125	01.02→	1	0 242 065 501	UR 09 AC	0,8
150 cc					
ATV 150	01.04→	1	0 242 065 500	UR 09 CC	0,7
200 cc					
ATV 220	01.06→	1	0 242 065 500	UR 09 CC	0,7
300 cc					
ATV 300	01.04→	1	0 242 150 507	XR 4 CC	0,7

AEON

50 cc					
Cobra 50	01.03→	1	0 242 240 561	WR 6 BC	0,8
Minikolt 50	01.03→	1	0 242 240 561	WR 6 BC	0,8
Revo 50	01.04→	1	0 242 240 561	WR 6 BC	0,8
100 cc					
Cobra 100	01.02→	1	0 242 240 561	WR 6 BC	0,8
Revo 100	01.04→	1	0 242 240 561	WR 6 BC	0,8
125 cc					
Cobra RS 125	01.03-12.06	1	0 242 060 506	UR 2 AC	0,8
Cobra Sport 125	01.02→	1	0 242 074 501	UR 07 AC	0,8
Cobra Utility 125	01.02→	1	0 242 060 506	UR 2 AC	0,8
Overland 125	01.04→	1	0 242 060 506	UR 2 AC	0,8
180 cc					
Cobra RS1 180	01.02-12.03	1	0 242 060 506	UR 2 AC	0,8
Cobra RS2 180	01.04→	1	0 242 065 501	UR 09 AC	0,8
LG 180	01.05→	1	0 242 065 501	UR 09 AC	0,8
Overland II 180	01.05→	1	0 242 065 501	UR 09 AC	0,8
Overland 180	01.04-12.04	1	0 242 060 506	UR 2 AC	0,8
Sport 180	01.02→	1	0 242 074 501	UR 07 AC	0,8
Utility 180	01.02→	1	0 242 060 506	UR 2 AC	0,8
220 cc					
Cobra 220	01.05→	1	0 242 065 501	UR 09 AC	0,6





ARCTIC CAT

90 cc						
ATV 90 YOUTH 2T	01.02-12.04	1	0 242 240 561	WR 6 BC		0,6
400 cc						
ATV 375	01.02-12.02	1	0 242 060 501	UR 2 CC		0,8
ATV 400	01.97-12.98	1	0 242 065 500	UR 09 CC		0,7
	01.02-12.08	1	0 242 060 501	UR 2 CC		0,8
ATV 400 DVX	01.04-12.08	1	0 242 060 501	UR 2 CC		0,6
ATV 400 TBX	01.05-12.06	1	0 242 060 501	UR 2 CC		0,6
450 cc						
ATV 450	01.96-12.97	1	0 242 065 500	UR 09 CC		0,7

ATK

50 cc						
50 Mini Quad	01.01-12.03	1	0 241 245 580	W 5 AC		0,5
100 cc						
90 Mini Quad	01.01-12.03	1	0 241 245 580	W 5 AC		0,5

BAROSSA MOTOR

50 cc						
Mini 50	01.03-12.05	1	0 242 240 561	WR 6 BC		0,6
Python 50	01.03-12.06	1	0 242 240 561	WR 6 BC		0,8
100 cc						
Python 100	01.03-12.06	1	0 242 240 561	WR 6 BC		0,8
150 cc						
Magna 150	01.03-12.05	1	0 242 065 501	UR 09 AC		0,8
170 cc						
Magna 170	01.05-12.06	1	0 242 065 501	UR 09 AC		0,8
250 cc						
Magna 250	01.03-12.06	1	0 242 065 501	UR 09 AC		0,8

BLANEY

80 cc						
FX 70	01.99→	1	0 241 245 656	W 5 BC		0,7
90 cc						
FX 90	01.00→	1	0 241 245 656	W 5 BC		0,7
100 cc						
FX 100	01.00→	1	0 241 245 656	W 5 BC		0,7

BLAST (LEM)

50 cc						
Blast 50	01.00→	1	0 241 245 580	W 5 AC		0,5
100 cc						
Blast 100	01.00→	1	0 241 245 580	W 5 AC		0,5



Typ

**BOMBARDIER**

50 cc						
DS 50	01.02-12.03	1	0 242 240 561	WR 6 BC	0,6	
Quest 50	01.03-12.03	1	0 242 240 561	WR 6 BC	0,8	
90 cc						
DS 90 2T	01.02-12.03	1	0 242 240 561	WR 6 BC	0,6	
DS 90 4T	01.02-12.06	1	0 242 065 501	UR 09 AC	0,7	
Quest 90	01.03-12.03	1	0 242 065 501	UR 09 AC	0,7	
200 cc						
Relly 200	01.03-12.03	1	0 242 065 500	UR 09 CC	0,7	
300 cc						
Outlander 330	01.02-12.03	1	0 242 140 519	YR 6 DES	0,9	
400 cc						
Outlander 400	01.03-12.03	1	0 242 140 519	YR 6 DES	0,9	
500 cc						
Traxter 500	01.98-12.01	1	0 242 150 507	XR 4 CC	0,7	
	01.02-12.02	1	0 242 140 519	YR 6 DES	0,9	
650 cc						
DS 650	01.00-12.02	1	0 242 150 507	XR 4 CC	0,7	
Quest 650	01.02-12.02	1	0 242 140 519	YR 6 DES	0,9	

BRISTER

340 cc						
Chuck Wagon 340	01.05→	1	0 242 235 707	WR 7 DCX+	1,1	

BUSH HOG

480 cc						
Trail Hunter TH420 480	01.04-12.08	2	0 242 229 659	FR 8 DC+	0,6	
600 cc						
Trail Hunter TH440 614	01.04-12.08	2	0 242 235 663	WR 7 DC+	0,8	

CANNONDALE

440 cc						
Blaze 440	01.02-12.03	1	0 242 074 500	UR 07 CDC	0,7	
Cannibal 440	01.02-12.03	1	0 242 074 500	UR 07 CDC	0,7	
FX 400	01.00-12.01	1	0 242 074 500	UR 07 CDC	0,7	
Glamis 440	01.02-12.09	1	0 242 074 500	UR 07 CDC	0,7	
Moto 440	01.02-12.03	1	0 242 074 500	UR 07 CDC	0,7	
Speed 440	01.02-12.04	1	0 242 074 500	UR 07 CDC	0,7	

CPI

50 cc						
Crab 50	01.02-12.05	1	0 242 255 515	WR 3 BC 0	0,8	
Dirt Demon 50	01.02-12.02	1	0 242 255 515	WR 3 BC 0	0,8	
200 50	01.03-12.03	1	0 242 245 521	WR 5 CC	0,8	



◀ CPI

100 cc						
Crab 100	01.03-12.05	1	0 242 255 515	WR 3 BC 0		0,8
Dirt Demon 100	01.02-12.02	1	0 242 255 515	WR 3 BC 0		0,8
250 cc						
XS 250	01.06→	2	0 242 065 501	UR 09 AC		0,8

CUB CADET

300 cc						
Big Country	01.03-12.05	1	0 242 229 656	WR 8 DC+		0,7

DAREN

50 cc						
50	01.00→	1	0 242 240 561	WR 6 BC		0,8
100 cc						
100	01.00→	1	0 242 240 561	WR 6 BC		0,8
125 cc						
125	01.00→	1	0 242 150 507	XR 4 CC		0,7
150 cc						
150	01.00→	1	0 242 150 507	XR 4 CC		0,7

DAZON

50 cc						
Stinger 50	01.05→	1	0 242 065 501	UR 09 AC		0,8
150 cc						
Raider Classic 150	01.05→	1	0 242 065 501	UR 09 AC		0,7
Raider Max 150	01.05→	1	0 242 065 500	UR 09 CC		0,7
175 cc						
Raider Max 175	01.05→	1	0 242 065 500	UR 09 CC		0,7
250 cc						
Raider Max 250	01.05→	1	0 242 065 500	UR 09 CC		0,7

DINLI

50 cc						
Diamond Back 50	03.99→	1	0 242 240 561	WR 6 BC		0,8
DL501 Dino 50	03.99→	1	0 242 240 561	WR 6 BC		0,6
DL502 JP 50	03.99→	1	0 242 240 561	WR 6 BC		0,6
DL503 Cobia 50	03.99→	1	0 242 240 561	WR 6 BC		0,6
DL601 T-Rex 50	01.03→	1	0 242 240 561	WR 6 BC		0,8
Helix 50	01.04→	1	0 242 240 561	WR 6 BC		0,6
90 cc						
DL601 Diamond Back 90	03.99→	1	0 242 240 561	WR 6 BC		0,8
DL602 Beast 90	03.99→	1	0 242 240 561	WR 6 BC		0,8
DL603 Helix 90	03.99→	1	0 242 240 561	WR 6 BC		0,7
100 cc						
DL601 T-Rex 100	03.99→	1	0 241 235 754	W 7 BC		0,6
150 cc						
DL603 Helix 150	01.01→	1	0 241 056 502	U 3 AC		0,7



Typ



DL604 Diablo JP 150	01.01→	1	0 241 056 502	U 3 AC	0,6
DL605 Enforcer 150	01.01→	1	0 241 056 502	U 3 AC	0,7

DRR

50 cc					
DRX 50	01.04→	1	0 241 245 656	W 5 BC	0,7
90 cc					
DRX 90	01.04→	1	0 241 245 656	W 5 BC	0,7
DRX 90 GT	01.04→	1	0 241 056 502	U 3 AC	0,7

EATV

500 cc					
Evolution 510	01.05-12.10	1	0 242 140 519	YR 6 DES	0,6
625 cc					
Explorer 625	01.05→	1	0 242 150 507	XR 4 CC	0,6
950 cc					
Extreme 950	01.05→	2	0 242 060 505	UR 2 CDC	0,7
1000 cc					
Energia 992	01.05-12.10	2	0 242 140 519	YR 6 DES	0,6

EPELLA

150 cc					
X Rider 150	01.07→	1	0 242 065 501	UR 09 AC	0,7

E-TON

50 cc					
Viper 50	01.02-12.05	1	0 242 240 561	WR 6 BC	0,6
90 cc					
Sierra Ranger 90	01.00-12.05	1	0 242 240 561	WR 6 BC	0,8
Viper 2T 90	01.02-12.07	1	0 242 240 561	WR 6 BC	0,8
150 cc					
Yukon 150	01.99-12.07	1	0 241 056 502	U 3 AC	0,6

FOX

50 cc					
50	01.00→	1	0 242 240 561	WR 6 BC	0,8
50 VR Sport	01.01→	1	0 242 240 561	WR 6 BC	0,8
90 cc					
90 MT	01.99→	1	0 242 065 501	UR 09 AC	0,8
100 cc					
100	01.00→	1	0 242 240 561	WR 6 BC	0,8





Typ

**GAS-GAS**

300 cc						
300 Wild	01.02→	1	0 242 255 504	WR 3 CS		0,5
450 cc						
450 Wild	01.02→	1	0 242 065 500	UR 09 CC		0,7

GILERA (PIAGGIO)

250 cc						
Oregon 250	01.07→	1	0 242 065 500	UR 09 CC		0,6

HERKULES MOTOR

50 cc						
ATV 50 RS XXL	03.05→	1	0 242 240 561	WR 6 BC		0,8
ATV 50 V	01.04→	1	0 241 245 656	W 5 BC		0,7
100 cc						
ATV 100 V	01.04→	1	0 242 240 561	WR 6 BC		0,8
125 cc						
ATK 125 R Go Kart	01.04→	1	0 241 056 502	U 3 AC		0,7
150 cc						
ATV 150	01.04→	1	0 242 065 500	UR 09 CC		0,7
300 cc						
ATV 300	01.04→	1	0 242 150 507	XR 4 CC		0,7

HONDA

70 cc						
TRX 70	01.85-12.87	1	0 242 060 506	UR 2 AC		0,7
90 cc						
TRX 90	01.93-12.94	1	0 242 055 501	UR 3 AC		0,7
	01.95→	1	0 242 065 501	UR 09 AC		0,7
125 cc						
ATC 125 M	01.75-12.77	1	0 242 150 507	XR 4 CC		0,6
TRX 125	01.85-12.88	1	0 242 150 507	XR 4 CC		0,7
185 cc						
ATC 185	01.80-12.80	1	0 241 150 504	X 4 CC		0,7
	01.81-12.84	1	0 242 150 507	XR 4 CC		0,6
200 cc						
ATC 200	01.81-12.86	1	0 242 150 507	XR 4 CC		0,6
TRX 200	01.84-12.95	1	0 242 150 507	XR 4 CC		0,6
250 cc						
ATC 250 E	01.85-12.88	1	0 242 150 507	XR 4 CC		0,7
ATC 250 R	01.81-12.86	1	0 242 255 502	WR 3 CC		0,8
FL 250 Odyssey	01.77-12.84	1	0 242 255 502	WR 3 CC		0,8
TRX 250 FourTrax	01.85-12.87	1	0 242 150 507	XR 4 CC		0,6
TRX 250 R	01.86-12.89	1	0 242 255 502	WR 3 CC		0,6
	01.97→	1	0 242 145 516	XR 5 DC		0,9
300 cc						
TRX 300 EX	01.93→	1	0 242 150 507	XR 4 CC		0,6



TRX 300 FW 350 cc	01.88-12.00	1	0 242 145 516	XR 5 DC	0,9
ATC 350 X	01.85-12.86	1	0 242 150 507	XR 4 CC	0,7
FL 350 Odyssey	01.85-12.87	1	0 242 255 502	WR 3 CC	0,8
TRX 350 400 cc	01.86-12.93	1	0 242 150 507	XR 4 CC	0,6
TRX 400 FA	01.04-12.07	1	0 242 145 516	XR 5 DC	0,9

HUSQVARNA (CAGIVA)

450 cc					
QM 450	01.05→	1	0 242 065 500	UR 09 CC	0,6

HYOSUNG

50 cc					
WOW 50	01.04→	1	0 241 245 656	W 5 BC	0,7
50	01.03→	1	0 241 235 754	W 7 BC	0,7
90 cc					
WOW 90	01.04→	1	0 241 245 656	W 5 BC	0,7
90	01.03→	1	0 242 240 561	WR 6 BC	0,8
450 cc					
450 Rapiert	01.07→	1	0 242 065 500	UR 09 CC	0,6

JOHN DEERE

250 cc					
Gator 250	01.04→	1	0 242 229 656	WR 8 DC+	0,7
290 cc					
Gator 290	01.04→	1	0 242 229 656	WR 8 DC+	0,7
500 cc					
Buck 500	01.05→	1	0 242 150 507	XR 4 CC	0,7
Trail Buck 500	01.05→	1	0 242 140 519	YR 6 DES	0,9
650 cc					
Trail Buck 650	01.05→	1	0 242 140 519	YR 6 DES	0,9

KAWASAKI

185 cc					
KLF 185	01.87-12.88	1	0 242 160 503	XR 2 CE 0	0,7
220 cc					
KLF 220	01.88-12.02	1	0 242 160 503	XR 2 CE 0	0,7
250 cc					
KFX 250	01.87-12.04	1	0 242 145 516	XR 5 DC	0,9
KLF 250	01.02-12.10	1	0 242 160 503	XR 2 CE 0	0,7
KSF 250	01.87-12.04	1	0 242 145 516	XR 5 DC	0,9
300 cc					
KVF 300 Prairie	01.98-12.02	1	0 242 150 507	XR 4 CC	0,7
Mule 500	01.92-12.96	1	0 242 229 656	WR 8 DC+	0,8
Mule 550	01.97-12.04	1	0 242 229 656	WR 8 DC+	0,7



Typ



◀ KAWASAKI

360 cc						
KVF 360	01.03→	1	0 242 145 516	XR 5 DC	0,9	
400 cc						
KFX 400	01.03-12.06	1	0 242 060 501	UR 2 CC	0,8	
KLF 400	01.93-12.99	1	0 242 145 516	XR 5 DC	0,9	
KVF 400	01.99-12.02	1	0 242 145 516	XR 5 DC	0,9	
Mule 600	01.05→	1	0 242 229 656	WR 8 DC+	0,7	
Mule 610	01.07→	1	0 242 229 656	WR 8 DC+	0,7	
540 cc						
KAF 540	01.89-12.93	1	0 242 229 656	WR 8 DC+	0,6	
650 cc						
KVF 650	01.00→	2	0 242 060 501	UR 2 CC	0,8	
700 cc						
KFX 700	01.04-12.11	2	0 242 060 501	UR 2 CC	0,6	
KVF 700	01.04-12.08	2	0 242 060 501	UR 2 CC	0,8	
750 cc						
KVF 750	01.04→	2	0 242 060 501	UR 2 CC	0,8	

KOLPIN

50 cc						
50	01.04-12.08	1	0 242 255 515	WR 3 BC 0	0,8	
90 cc						
90	01.04-12.08	1	0 242 255 515	WR 3 BC 0	0,8	

KREIDLER

50 cc						
Mini Mustang 50	01.05→	1	0 242 240 561	WR 6 BC	0,8	
Mustang 50	01.05→	1	0 242 240 561	WR 6 BC	0,8	
100 cc						
F-Kart 100	01.05→	1	0 242 240 561	WR 6 BC	0,8	
170 cc						
Mustang 170	01.04→	1	0 242 150 507	XR 4 CC	0,7	
200 cc						
Mustang 200	01.05→	1	0 242 150 507	XR 4 CC	0,7	

KYMCO

50 cc						
MX 50	01.01→	1	0 242 255 515	WR 3 BC 0	0,5	
MXer 50	01.05→	1	0 242 255 515	WR 3 BC 0	0,5	
MXU 50	01.05→	1	0 242 255 515	WR 3 BC 0	0,5	
500 cc						
MXU 500 4x4	01.06→	1	0 242 065 500	UR 09 CC	0,6	

LEM MOTOR

50 cc						
Cayman LC 50	01.02-12.05	1	0 241 245 580	W 5 AC	0,5	
Cayman 50	01.96-12.04	1	0 242 260 500	WR 2 AC	0,6	



Typ



Condor S6 50	01.02-12.06	1	0 241 245 580	W 5 AC	0,5
Condor 50	01.96-12.04	1	0 242 260 500	WR 2 AC	0,6

LINHAI

260 cc					
260	01.05→	1	0 242 150 507	XR 4 CC	0,7

MANCO

50 cc					
Mini Indy 50	01.01-12.05	1	0 242 235 533	WR 7 AC	0,7
Stock Kar 50	01.01-12.05	1	0 242 235 533	WR 7 AC	0,7
ZSR 50	01.02-12.07	1	0 242 240 561	WR 6 BC	0,8
90 cc					
ZSR 90	01.02-12.07	1	0 242 240 561	WR 6 BC	0,8
130 cc					
Bandit Kart 130	01.03-12.07	1	0 242 235 533	WR 7 AC	0,6
Critter Kart 130	01.04-12.06	1	0 242 235 533	WR 7 AC	0,7
Eliminator Kart 130	01.04-12.07	1	0 242 235 533	WR 7 AC	0,6
Quicksilver Kart 130	01.04-12.07	1	0 242 235 533	WR 7 AC	0,7
170 cc					
Eliminator Kart 170	01.06-12.07	1	0 242 235 533	WR 7 AC	0,7
EZ Rider 170	01.04-12.05	1	0 242 235 533	WR 7 AC	0,7
210 cc					
Aerforce Kart 210	01.06-12.07	1	0 242 235 533	WR 7 AC	0,7
Intruder Kart 210	01.04-12.06	1	0 242 235 533	WR 7 AC	0,7
260 cc					
Aerforce Kart 260	01.06-12.07	1	0 242 235 533	WR 7 AC	0,7
Talon 260	01.04-12.07	1	0 242 150 507	XR 4 CC	0,7
400 cc					
XTK 713E 400	01.04-12.07	1	0 242 235 533	WR 7 AC	0,6
450 cc					
Super Deuce 450	01.00-12.03	2	0 242 229 656	WR 8 DC+	0,7

MOTOR TEK

50 cc					
MT 50	01.05→	1	0 242 255 515	WR 3 BC 0	0,5
125 cc					
MT 125	01.05→	1	0 242 065 501	UR 09 AC	0,8
175 cc					
MT 175	01.05→	1	0 242 150 507	XR 4 CC	0,7

MSA

50 cc					
Fox 50	01.00-12.10	1	0 242 255 515	WR 3 BC 0	0,8
Sport 50	01.00-12.10	1	0 242 255 515	WR 3 BC 0	0,8
90 cc					
Fox 90	01.00-12.10	1	0 242 065 501	UR 09 AC	0,6



Typ



◀ MSA

100 cc					
Fox 100	01.00-12.10	1	0 242 255 515	WR 3 BC 0	0,8
Sport 100	01.00-12.10	1	0 242 255 515	WR 3 BC 0	0,8

MZ (MOTORRADWERKE ZSCHOPAU)

150 cc					
KX 150	01.05→	1	0 242 060 501	UR 2 CC	0,6
VRS 150	01.05→	1	0 242 060 501	UR 2 CC	0,6

PANDA

50 cc					
KD 50A	01.00-12.01	1	0 242 055 501	UR 3 AC	0,7
80 cc					
KD 80A	01.00-12.01	1	0 242 055 501	UR 3 AC	0,7
125 cc					
KD 125A	01.00-12.01	1	0 242 055 501	UR 3 AC	0,7

POLARIS

50 cc					
Predator 50	01.04→	1	0 242 240 561	WR 6 BC	0,8
Scrambler 50	01.01-12.04	1	0 242 240 561	WR 6 BC	0,8
90 cc					
Predator 90	01.03→	1	0 242 240 561	WR 6 BC	0,8
Scrambler 90	01.01→	1	0 242 240 561	WR 6 BC	0,8
Sportsman 90	01.01→	1	0 242 240 561	WR 6 BC	0,8
200 cc					
Phoenix 200	01.05→	1	0 242 065 501	UR 09 AC	0,6
250 cc					
Big Boss 250	01.89-01.93	1	0 242 250 503	WR 4 CC	0,6
Cyclone 250	01.88-12.89	1	0 242 250 503	WR 4 CC	0,6
Scrambler 250	01.89-01.93	1	0 242 250 503	WR 4 CC	0,6
Trail Blazer 250	01.90→	1	0 242 250 503	WR 4 CC	0,6
Trail Boss 250	01.85→	1	0 242 250 503	WR 4 CC	0,6
Xplorer 250	01.00-12.02	1	0 242 250 503	WR 4 CC	0,5
300 cc					
Xplorer 300	01.94-12.00	1	0 242 250 503	WR 4 CC	0,6
Xpress 300	01.94-12.00	1	0 242 250 503	WR 4 CC	0,6
350 cc					
Big Boss 350	01.93→	1	0 242 250 503	WR 4 CC	0,6
Trail Boss 350	01.90-12.93	1	0 242 250 503	WR 4 CC	0,6
400 cc					
Big Boss EC38 400	01.95-12.98	1	0 242 250 503	WR 4 CC	0,5
Big Boss 400L	01.95-12.97	1	0 242 250 503	WR 4 CC	0,6
Scrambler EC38 400	01.94-12.02	1	0 242 250 503	WR 4 CC	0,5
Scrambler 400	01.94→	1	0 242 250 503	WR 4 CC	0,6
Sport EC38 400	01.95-12.99	1	0 242 250 503	WR 4 CC	0,5
Sport 400	01.95→	1	0 242 250 503	WR 4 CC	0,6
Sportsman EC38 400	01.94-12.97	1	0 242 250 503	WR 4 CC	0,5
	01.03→	1	0 242 229 659	FR 8 DC+	0,6



Sportsman 400	01.94-12.97	1	0 242 250 503	WR 4 CC	0,6
Trail Blazer EC38 400	01.03→	1	0 242 250 503	WR 4 CC	0,5
Xplorer EC38 400	01.94-12.02	1	0 242 250 503	WR 4 CC	0,5
Xplorer 400	01.94→	1	0 242 250 503	WR 4 CC	0,6
Xpress EC38 400	01.96-12.97	1	0 242 250 503	WR 4 CC	0,5
Xpress 400	01.94→	1	0 242 250 503	WR 4 CC	0,6
425 cc					
Expedition 425	01.01-12.09	1	0 242 229 659	FR 8 DC+	0,6
Magnum 425	01.95→	1	0 242 229 659	FR 8 DC+	0,6
Ranger 425	01.02→	1	0 242 229 659	FR 8 DC+	0,6
Sportsman 425	01.01-12.09	1	0 242 229 659	FR 8 DC+	0,6
500 cc					
Big Boss 500	01.98→	1	0 242 229 659	FR 8 DC+	0,6
Hauler Light Utility EH50	01.02-01.09	1	0 242 229 659	FR 8 DC+	0,6
Magnum 500	01.99→	1	0 242 229 659	FR 8 DC+	0,6
Predator 500	01.03→	1	0 242 140 519	YR 6 DES	0,9
Pro ATV EH50 500	01.02-12.03	1	0 242 229 659	FR 8 DC+	0,6
Ranger 500	01.99→	1	0 242 229 659	FR 8 DC+	0,6
Scrambler 500	01.98→	1	0 242 229 659	FR 8 DC+	0,6
Sportsman X2 500	01.06→	1	0 242 229 659	FR 8 DC+	0,6
Sportsman 500	01.96-12.04	1	0 242 229 659	FR 8 DC+	0,6
Task Force Utility EH50	01.02-01.09	1	0 242 229 659	FR 8 DC+	0,6
Xplorer 500	01.97→	1	0 242 229 659	FR 8 DC+	0,6

SACHS (FICHTEL & SACHS AG)

50 cc					
Little Devil 50	01.04→	1	0 241 235 754	W 7 BC	0,6
T-Rex 50	01.04→	1	0 242 240 561	WR 6 BC	0,6
4rock 50	01.06→	1	0 242 240 561	WR 6 BC	0,7
100 cc					
Helix 100	01.04→	1	0 242 240 561	WR 6 BC	0,6
T-Rex 100	01.04→	1	0 242 240 561	WR 6 BC	0,6
110 cc					
4rock 110	01.06→	1	0 242 240 561	WR 6 BC	0,7
150 cc					
Helix 150	01.04→	1	0 241 056 502	U 3 AC	0,6
4rock 150	01.05→	1	0 241 056 502	U 3 AC	0,7

SUZUKI

50 cc					
LT-Z 50	01.06→	1	0 242 055 501	UR 3 AC	0,7
80 cc					
LT 80	01.95-12.06	1	0 242 240 561	WR 6 BC	0,7
90 cc					
LT-Z 90	01.07→	1	0 242 055 501	UR 3 AC	0,7
250 cc					
LT 250	01.93-12.00	1	0 241 150 504	X 4 CC	0,7
300 cc					
LT-300	01.87-12.89	1	0 241 150 504	X 4 CC	0,6
400 cc					
LT 400	01.02-12.07	1	0 242 060 501	UR 2 CC	0,6



◀ SUZUKI

LT-A 400 F Kingquad	01.08-12.12	1	0 242 060 501	UR 2 CC	0,7
LT-F 400 Kingquad	01.08-12.12	1	0 242 060 501	UR 2 CC	0,7
LT-Z 400 QuadSport	01.03→	1	0 242 060 501	UR 2 CC	0,7
450 cc					
LT-R 450	01.06-12.12	1	0 242 065 500	UR 09 CC	0,7
500 cc					
LT-F 500	01.98-12.99	1	0 242 060 501	UR 2 CC	0,6

SYM

250 cc					
Quad Lander 250	01.05→	1	0 242 065 500	UR 09 CC	0,6

TRAILBLAZER

50 cc					
Blazer 50	01.05→	1	0 241 245 656	W 5 BC	0,7
Blazer 50 Mini	01.05→	1	0 242 240 561	WR 6 BC	0,7
90 cc					
Blazer 90 2T	01.05→	1	0 241 245 656	W 5 BC	0,7
Blazer 90 4T	01.05→	1	0 242 065 501	UR 09 AC	0,7
170 cc					
Blazer 170	01.04→	1	0 242 150 507	XR 4 CC	0,7
250 cc					
Blazer 250	01.05→	2	0 242 074 501	UR 07 AC	0,8

UNILLI

150 cc					
KX 150	01.05→	1	0 242 060 501	UR 2 CC	0,6

UNISON

50 cc					
Desert Cat 50	01.04→	1	0 242 260 500	WR 2 AC	0,6
90 cc					
Desert Cat 90	01.04→	1	0 242 260 500	WR 2 AC	0,6

UNITED MOTORS

50 cc					
Dirt Squirt 50	01.00-12.04	1	0 242 260 500	WR 2 AC	0,6
Moontrax 50	01.05→	1	0 242 240 561	WR 6 BC	0,8
90 cc					
Dirt Squirt 90	01.00-12.04	1	0 242 260 500	WR 2 AC	0,6
Earthlander 90	01.05→	1	0 242 240 561	WR 6 BC	0,8
Moontrax 90	01.05→	1	0 242 240 561	WR 6 BC	0,6
Reptil 90	01.00-12.04	1	0 241 056 502	U 3 AC	0,7



Typ



VENTO

100 cc					
Avalanche EX100	01.07→	1	0 242 235 665	WR 7 BC+	0,7
250 cc					
Rhino 250	01.08→	1	0 242 150 507	XR 4 CC	0,7

XING FU

150 cc					
XF Trail 150	01.05→	1	0 241 056 502	U 3 AC	0,6
250 cc					
XF Trail 250	01.05→	2	0 241 056 502	U 3 AC	0,6

YAMAHA

50 cc					
YMF 50 S	01.04→	1	0 242 060 506	UR 2 AC	0,7
60 cc					
YF 60	01.87-12.88	1	0 242 235 665	WR 7 BC+	0,7
80 cc					
YFM 80	01.92-12.01	1	0 241 056 502	U 3 AC	0,7
	01.02-12.08	1	0 242 060 506	UR 2 AC	0,7
125 cc					
YFA1 125 Breeze	01.89-12.04	1	0 242 060 506	UR 2 AC	0,7
YFA1 125 F	01.94-12.04	1	0 241 056 502	U 3 AC	0,7
200 cc					
YFS 200 Blaster	01.90-12.94	1	0 241 248 538	W 4 CC	0,8
	01.95-12.06	1	0 242 250 503	WR 4 CC	0,8
300 cc					
Golf Car G2 300	01.85-12.91	1	0 241 229 579	W 8 CC	0,7
Golf Car G9 300	01.91-12.95	1	0 241 229 579	W 8 CC	0,7
350 cc					
YFM 350	01.87→	1	0 242 150 507	XR 4 CC	0,7
YFZ 350	01.86→	2	0 242 250 503	WR 4 CC	0,8
400 cc					
YFM 400	01.93→	1	0 242 150 507	XR 4 CC	0,7
450 cc					
YFZ 450	01.04→	1	0 242 065 500	UR 09 CC	0,7
700 cc					
YFM 700	01.05→	1	0 242 060 501	UR 2 CC	0,6

YERF-DOG

90 cc					
23000	01.04-12.09	1	0 241 245 656	W 5 BC	0,7





Typ



ZONGSHEN

125 cc
ZS 125 ST

01.04→

1

0 242 229 659

FR 8 DC+

0,6





PIAGGIO

APE					
APE 50 FL2	01.91-12.05	1	0 241 235 607	W 7 AC	0,5
APE 601 V	01.77-12.90	1	0 241 245 580	W 5 AC	0,5
APE 703 TM	01.84-12.96	1	0 241 245 580	W 5 AC	0,5



de

Gegenüberstellung Benutzerhinweise

Im nachfolgenden Katalogteil sind Bestellnummern von Herstellern anderer Marken, für die es einbaugleiche Bosch-Erzeugnisse oder -Teile gibt, aufgeführt. Da die verschiedenartigsten Bezeichnungssysteme angewendet werden, konnten die fremden Bestellnummern nur in einer einheitlichen, alphanumerischen Sortierfolge geordnet werden. Sie weicht bei einigen Herstellern von der dort üblichen Sortierfolge ab.

„Werden Bosch-Teile mit Teilenummern versehen, sind aus wettbewerbsrechtlichen Gründen in jedem Fall die jeweiligen Bosch-Teilenummern zu verwenden und als solche kenntlich zu machen. Daneben können auch fremde Teilenummern verwendet werden, um die technische bzw. funktionale Gleichwertigkeit der jeweiligen Produkte zum Ausdruck zu bringen.“

Ggf. sollten nach Möglichkeit fremde Teilenummern sogleich mehrerer Hersteller aufgeführt werden.

Eine fremde Teilenummer ist dabei eindeutig als solche eines anderen Herstellers kenntlich zu machen, wie insbesondere durch gleichzeitige Nennung des fremden Herstellers bzw. der fremden Marke sowie deren eindeutige Zuordnung zu der fremden Teilenummer.

Alle Angaben dürfen nur in Standard-Schrift erfolgen. Insbesondere dürfen keine Logos oder besondere Schriftzüge der fremden Hersteller verwendet und ihre Marken bzw. Namen auch sonst nicht besonders hervorgehoben werden.

Vielmehr sollte die Nennung fremder Namen, Marken und Teilenummern generell möglichst unauffällig erfolgen.“

en

Cross-reference Notes for users

The following catalog section lists part numbers of non-Bosch equipment for which there are interchangeable Bosch products or components available. Since a wide range of different designation systems are used, we were forced to arrange the non-Bosch part numbers in a uniform alphanumerical order. This differs from the customary order employed by some manufacturers.

“If part numbers are assigned to Bosch parts, the corresponding Bosch part numbers are always to be used and clearly identified as such to satisfy the law on competition. Use can additionally be made of non-Bosch part numbers to express the equivalent technical and functional properties of the products concerned.

If applicable, the non-Bosch part numbers of several manufacturers should be listed wherever possible.

When doing so, a non-Bosch part number is to be clearly identified as that of another manufacturer, in particular by naming the other manufacturer or the non-Bosch make and clearly assigning this to the non-Bosch part number.

All such information must always be given in standard typeface. In particular, use is not to be made of any logos or special emblems of other manufacturers and their brands and names are not to be specially highlighted in any other way.

On the contrary, mention should only be made of non-Bosch names, makes and part numbers as inconspicuously as possible.“

fr

Table de correspondance A l'attention de l'utilisateur

Cette section du catalogue reprend les références des fabricants d'autres marques pour lesquelles il existe des produits ou des composants Bosch de montage identique. De multiples systèmes de codage étant utilisés, les références des produits d'autres marques ne peuvent être reprises que suivant un classement alphanumérique uniforme. Pour certains fabricants, ce classement peut différer de celui qu'ils utilisent habituellement.

«Si des pièces Bosch sont munies de références, pour des raisons liées à la législation sur la concurrence, les références Bosch correspondantes doivent être utilisées dans tous les cas et être rendues identifiables comme telles. Parallèlement, des références étrangères peuvent également être utilisées pour exprimer l'équivalence technique ou fonctionnelle des produits considérés.

Le cas échéant, indiquer si possible concomitamment les références étrangères de plusieurs fabricants.

Une référence étrangère doit être identifiée clairement comme étant celle d'un autre fabricant, notamment par l'indication simultanée de l'autre fabricant ou de l'autre marque, de même que par leur correspondance claire à la référence étrangère.

Toutes les indications doivent être effectuées dans la police standard. Aucun logo ou monogramme particulier des fabricants étrangers ne doit en particulier être utilisé et leurs marques ou noms ne doivent être mis en valeur d'aucune autre façon.

Au contraire, les noms, marques et références étrangers doivent, d'une manière générale, être cités de façon aussi discrète que possible.»

it

Comparazione Avvertenze per la consultazione

Nella seguente parte del catalogo vengono riportati i numeri di ordinazione di costruttori di prodotti d'altra marca, per i quali sono disponibili prodotti o parti di prodotti Bosch di corrispondente applicazione. Dato che vengono utilizzati i più diversi sistemi di denominazione, si è potuto ordinare i numeri di ordinazione di altra marca solo in una sequenza di classificazione unitaria ed alfanumerica. Per alcune case costruttrici si differenzia perciò dalla sequenza di classificazione normalmente usata. In questo confronto le sigle Bosch vanno considerate come dati indicativi.

«Qualora componenti Bosch vengano corredati di codici, per motivi legati alle leggi che regolano la concorrenza si devono utilizzare in ogni caso i relativi codici Bosch evidenziandoli come tali. L'utilizzo di codici di altra marca è comunque possibile per esprimere una equivalenza tecnica o funzionale dei relativi prodotti.

Possibilmente è da preferire l'indicazione contemporanea di codici di diversi costruttori.

Un codice che non sia Bosch va evidenziato in modo univoco in tal senso, in particolare nominando contestualmente il costruttore o la marca di appartenenza.

Tutte le indicazioni devono essere riportate ricorrendo a caratteri standard. In particolare non si devono utilizzare loghi o scritte particolari usati dai costruttori di prodotti di altra marca né si devono mettere in risalto i relativi marchi o nomi.

Al contrario, l'indicazione di nomi, marche e codici diversi da Bosch dovrebbe essere in genere quanto più discreta possibile.»

es

Equivalencias Indicaciones para el usuario

A continuación se han relacionado números de pedido de fabricantes de otras marcas para los que existen productos o piezas Bosch de iguales características. Dado que se utilizan los más diversos sistemas de designación, los números de pedido ajenos han podido relacionarse tan sólo en un orden unificado, alfanumérico. En el caso de algunos fabricantes, el orden de esta clasificación difiere del que utilizan habitualmente.

«Si piezas Bosch se dotan de números de pieza, por motivos de índole legal relativos a la competencia se deben utilizar en cualquier caso los respectivos números de pieza Bosch, identificándolos como tales debidamente. Paralelamente se pueden usar también números de pieza ajenos para poner de manifiesto la equivalencia técnica o funcional de los respectivos productos.

En su caso y en la medida de lo posible, se deberían citar al mismo tiempo números de pieza ajenos de varios fabricantes.

Un número de pieza ajeno se debe identificar en estos casos claramente como perteneciente a otro fabricante, por ejemplo citando simultáneamente al fabricante ajeno o la marca ajena así como estableciendo la correspondencia de éstos con el número de pieza ajeno.

Todos los datos se deben escribir solo con letra estándar. En particular, no se permite utilizar logotipos o caracteres gráficos propios de los fabricantes ajenos, ni tampoco destacar sus marcas y nombres de manera especial.

Por el contrario, los nombres, las marcas y los números de piezas de empresas ajenas se deberían citar, en general, de la forma más discreta posible.»

pt

Comparação**Instruções para o utilizador**

Na parte do catálogo que se segue, apresentam-se os números de referência de fabricantes de outras marcas e, em alguns casos, de fabricantes de veículos, para as quais existem produtos ou peças equivalentes aos da Bosch. Sendo os sistemas de designação dos mais variados tipos, os números de referência de fabricantes externos só puderam ser catalogados numa sequência alfanumérica única. Esta desvia-se da sequência de catalogação normalmente utilizada por alguns fabricantes.

«Se as peças Bosch estiverem identificadas com um número de peça, devem ser usados sempre os respectivos números de peça Bosch e ser identificados como tal, por motivos relacionados com a lei da concorrência. Podem ser usados adicionalmente números de peça de terceiros para destacar a equivalência técnica ou funcional dos respectivos produtos.

Se necessário, e consoante a possibilidade, deveriam ser indicados os números de peça de terceiros de vários fabricantes em simultâneo.

Contudo, um número de peça de terceiros deve ser claramente identificado como sendo de outro fabricante, nomeando tanto o outro fabricante ou a outra marca, como a respectiva atribuição de inequívoca do número de peça de terceiros.

Todas as indicações têm de ser expressas em letra standard. Não podem, sobretudo, ser usados quaisquer logótipos ou inscrições especiais de outros fabricantes, nem ser destacada, de modo algum, a marca ou o nome.

Por norma, é desejável que a menção de nomes, marcas e números de peça de terceiros seja feita da forma menos visível possível.»

nl

Opzoektabel**Aanwijzingen voor de gebruiker**

In het hierna volgende deel van de catalogus vindt u bestelnummers van fabrikanten van andere merken, waarvoor identiek geconstrueerde Bosch-producten of -onderdelen bestaan. Aangezien de meest uiteenlopende nummeringsystemen in gebruik zijn, kunnen we de bestelnummers van andere fabrikanten slechts presenteren in één uniforme, alfanumerieke sorteervolgorde.

Indien Bosch-onderdeelnummers van onderdeelnummers worden voorzien, moeten om redenen van het concurrentiecht in elk geval de desbetreffende Bosch-onderdeelnummers worden gebruikt en als zodanig kenbaar worden gemaakt. Daarnaast kunnen ook externe onderdeelnummers worden gebruikt om de technische resp. functionele gelijkwaardigheid van de desbetreffende producten uit te drukken.

Eventueel moeten, indien mogelijk, externe onderdeelnummers van meerdere fabrikanten worden vermeld.

Een extern onderdeelnummer moet daarbij duidelijk als onderdeel van een andere fabrikant kenbaar worden gemaakt, zoals in het bijzonder door gelijktijdig de externe fabrikant resp. het externe merk te vermelden en dit duidelijk toe te wijzen aan het externe onderdeelnummer.

Alle gegevens moeten uitsluitend in een standaard lettertype plaatsvinden. In het bijzonder mogen er geen logo's of bijzondere lettertypes van de externe fabrikant worden gebruikt en hun merk resp. naam mag ook niet bijzonder worden geaccentueerd.

Het noemen van namen, merken en onderdeelnummers moet over het algemeen zo onopvallend als mogelijk gebeuren.»

sv

Jämförelse**Bruksanvisning**

I efterföljande katalogdel ingår artikelnummer på de produkter av annan tillverkning, för vilka utbytbara Boschprodukter eller delar finns. Eftersom olika beteckningssystem används, har de främmande artikelnumren endast kunnat sorteras i en enhetlig, alfanumerisk följd, som avvikar från sedvanlig sorteringsföljd när det gäller en del tillverkare.

«Om Bosch reservdelar förses med reservdelnummer ska av konkurrensrättsliga skäl alltid respektive Bosch-reservdelnummer användas och kännetecknas som sådant. Därutöver kan även främmande reservdelnummer användas, för att markera att teknisk resp. funktionell likvärdighet består med respektive produkt. Om möjligt bör samtidigt främmande reservdelnummer för flera tillverkare anges.

Därvid ska det entydigt framgå att det främmande reservdelnumret härrör från en annan tillverkare, genom att framför allt den främmande tillverkaren eller det främmande märket samtidigt nämns samt dess entydiga allokering till det främmande reservdelnumret.

Alla angivelser får bara göras med standardskrift. I synnerhet får inga logotyper eller speciella fonter från den främmande tillverkaren användas och inte heller dess märke eller namn speciellt framhållas.

Tvärtom ska främmande namn, märken och reservdelnummer generellt sett användas så diskret som möjligt.»

cs

Převod**Pokyny pro uživatele**

V následujícím dílu katalogu jsou uvedena objednací čísla výrobků jiných značek, pro něž existují montážně shodné výrobky nebo díly Bosch. Protože se používají nejrůznější systémy označování, mohou být cizí objednací čísla uspořádána jen v jednotné, alfanumerické posloupnosti třídění. U některých výrobců se mohou vyskytovat odchylky od zde používané běžné posloupnosti třídění.

„Jestliže jsou díly Bosch opatřeny číslem dílu, je z konkurenčně legálních důvodů v každém případě nutno používat čísla dílů Bosch jako takové je označovat. Kromě toho mohou být používána také cizí čísla dílů, aby se vyjádřila technická popř. funkční ekvivalence příslušného produktu.

Podle možností měla být případně uváděna cizí čísla dílů hned několika výrobců.

Cizí číslo dílu jiného výrobce je přitom jako takové třeba jednoznačně označit, zejména současným pojmenováním cizího výrobce popř. cizí značky a uvádět rovněž jejich jednoznačné přiřazení k cizímu číslu dílu.

Všechny údaje smí být uváděny jen standardním písmem.

Zejména se nesmí používat žádná loga nebo zvláštní nápisy cizích výrobců, a jejich značky popř. jména také nesmí nijak zvlášť zvýrazňovat.

Spíše by měla být pojmenování cizími názvy, značkami a čísly dílů obecně pokud možno nenápadná.»

ru

Сопоставления**Вниманию пользователей**

В следующей части каталога приводятся номера для заказов производителей других марок, для которых имеются идентичные изделия или запчасти компании Bosch. Поскольку используются различные системы обозначений, номера заказов других производителей располагаются в едином алфавитно-цифровом порядке. Для некоторых производителей они отличаются от используемого у них порядка классификации.

«Если изделия Bosch имеют номера деталей, то по причинам законодательных положений в области конкуренции в любом случае необходимо использовать соответствующие номера Bosch и показывать их. Кроме того, можно использовать также номера деталей других производителей, чтобы показать техническую и функциональную равноценность соответствующих изделий.

В отдельных случаях необходимо по возможности указывать номера деталей нескольких производителей.

Номер детали другого производителя явно показывать как таковой, например, одновременно называя другого производителя или другую марку, а также их однозначное отношение к номеру детали другого производителя.

Все данные должны указываться стандартным шрифтом. В особенности, не разрешается использовать логотипы и специальные надписи других производителей и особым образом выделять их марки и названия.

Напротив, названия, марки и номера деталей других производителей всегда необходимо указывать по возможности неброско.»

ABS	Für Fahrzeuge mit ABS
AG	Für Fahrzeuge mit automatischem Getriebe
DOV	Doppelzündung, pro Zylinder werden 2 unterschiedliche Zündkerzen benötigt
ERL	Für Fahrzeuge mit erhöhter Leistung
EU2	Für Fahrzeuge mit Abgasnorm Euro 2
EU2	Nicht für Abgasnorm Euro 2
FE	Entstört
GS	Für Fahrzeuge mit Handschaltgetriebe
KAT	Für Fahrzeuge mit Katalysator

KAF	Für Fahrzeuge ohne Katalysator
LEN	Für Motor mit Normalleistung
LET	Für Motor mit Niedrigleistung
STT	Standard Typ
TW	Eingebautes Erzeugnis muss am Fahrzeug oder Motor ermittelt werden.
WW	Wahlweise
XJB	Kurzgewinde
XJC	Langgewinde



Bestellnummer



SB-Verpackung



EAN-Code SB-Verpackung



Gegenüberstellung



Seitenverweis



Elektrodenabstand in mm



Entstört



Gewinde



Schlüsselweite



Gewindelänge



Elektroden-Material



Flachdichtsitz



Zündkerze



Anschlussart



Mofa



Motorrad



Motorroller



Dreirad Pritsche



Quad



Datum / Einbauzeitraum



Zylinderzahl



ABS	For vehicles with ABS
AG	For vehicles with automatic transmission
DOV	Dual ignition, 2 different spark plugs are required per cylinder
ERL	For vehicles with increased power
EU2	For vehicles with emission standard Euro 2
EU2	Not for emission standard Euro 2
FE	Suppressed
GS	For vehicles with manual transmission
KAT	For vehicles with catalytic converter

KAF	For vehicles without catalytic converter
LEN	For engine with normal power
LET	For engine with low power
STT	Standard type
TW	The product fitted must be identified on the vehicle or engine
WW	Optional
XJB	Short thread
XJC	Long thread



Part number



Self-service pack



EAN code self-service pack



Cross-reference



Page reference



Electrode gap in mm



With interference suppression



Thread



Width across flats (A/F)



Thread length



Electrode material



Flat seat



Spark plug



Type of connection



Moped



Motorcycle



Scooter



Three-wheel pick-up



Quad



Date/ Production period



Number of cylinders

ABS	Pour véhicules avec ABS
AG	Pour véhicules avec boîte automatique
DOV	Allumage double, 2 bougies différentes nécessaires par cylindre
ERL	Pour véhicules à puissance accrue
EU2	Pour véhicules avec norme antipollution Euro 2
EU2	Pas pour norme antipollution Euro 2
FE	Antiparasité
GS	Pour véhicules avec boîte manuelle
KAT	Pour véhicules avec catalyseur

KAF	Pour véhicules sans catalyseur
LEN	Pour moteur de puissance normale
LET	Pour moteur de faible puissance
STT	Type standard
TW	Le produit monté doit être déterminé sur le véhicule ou le moteur.
WW	Au choix
XJB	Filetage court
XJC	Filetage long



Référence



Emballage libre-service



Code EAN emballage libre-service



Comparaison



Renvoi à la page



Ecartement des électrodes en mm



Antiparasité



Filetage



Ouverture de clé



Longueur du filetage



Matériau des électrodes



Siège plat



Bougie d'allumage



Mode de raccordement



Cyclomoteur



Moto



Scooter



Tricycle plateau



Quad



Date/période de montage



Nombre de cylindres



ABS	Per veicoli con ABS
AG	Per veicoli con cambio automatico
DOV	Accensione doppia, per ciascun cilindro sono necessarie 2 candele di accensione diverse
ERL	Per veicoli con potenza superiore
EU2	Per veicoli con norma sui gas di scarico Euro 2
EU2	Non per norma sui gas di scarico Euro 2
FE	Schermato
GS	Per veicoli con cambio meccanico
KAT	Per veicoli con catalizzatore

KAF	Per veicoli senza catalizzatore
LEN	Per motore con prestazioni normali
LET	Per motore con prestazioni ridotte
STT	Tipo Standard
TW	Il prodotto montato deve essere rilevato sul veicolo o sul motore.
WW	A scelta
XJB	Filettatura corta
XJC	Filettatura lunga



Numero di ordinazione



Confezione self-service



Codice EAN confezione self-service



Confronto



Rimando ad un'altra pagina



Distanza elettrodi in mm



Schermato



Filettatura



Apertura chiave



Lunghezza filettatura



Materiale elettrodi



Sede di tenuta piatta



Candela di accensione



Tipo di collegamento



Mofa



Motociclo



Scooter



Tre ruote cassone



Quad



Data/Periodo di montaggio



Numero cilindri

ABS	Para vehículos con ABS
AG	Para vehículos con cambio automático
DOV	Encendido doble, por cilindro se necesitan 2 diferentes bujías de encendido
ERL	Para vehículos con carga útil elevada
EU2	Para vehículos con norma de gases de escape EURO 2
EU2	No para norma de gases de escape Euro 2
FE	Antiparasitario
GS	Para vehículos con cambio manual
KAT	Para vehículos con catalizador

KAF	Para vehículos sin catalizador
LEN	Para motor con potencia normal
LET	Para motor de baja potencia
STT	Tipo Standard
TW	El producto montado se debe determinar en el vehículo o en el motor.
WW	A elección
XJB	Rosca corta
XJC	Rosca larga



Número de referencia



Envase autoservicio



Código EAN de embalaje de autoservicio



Confrontación



Referencia de página



Separación de electrodos en mm



Con supresión de interferencias



Rosca



Entrecaras



Longitud de rosca



Material de electrodos



Asiento de junta plana



Bujía de encendido



Tipo de conexión



Mofa



Motocicletas



Ciclomotor / escúter



Triciclo c/ caja de carga



Quad



Fecha/periodo de fabricación



Número de cilindros



ABS	Para veículos com ABS
AG	Para veículos com caixa de câmbio automática
DOV	Ignição dupla, são necessárias 2 velas de ignição distintas para cada cilindro
ERL	Para veículos com potência aumentada
EU2	Para veículos com norma relativa aos gases de escape Euro 2
EU2	Não para norma relativa aos gases de escape Euro 2
FE	Supressão de interferências
GS	Para veículos com caixa de câmbio manual

KAT	Para veículos com catalisador
KAT	Para veículos sem catalisador
LEN	Para motores com rendimento normal
LET	Para motores com baixo rendimento
STT	Tipo standard
TW	Produto montado tem que ser averiguado no veículo ou no motor.
WW	Opcional
XJB	Rosca curta
XJC	Rosca longa



Número de pedido



Embalagem serviço próprio



Código EAN embalagem self-service



Confrontação



Referência do lado



Distância eléctrodos em mm



Com interferências



Rosca



Abertura da chave



Comprimento da rosca



Material dos eléctrodos



Assento de vedação plano



Vela de ignição



Tipo de ligação



Ciclomotor



Motocicleta



Motorizada



Plataforma de três rodas



Moto 4



Data/Período de instalação



Número de cilindros

ABS	Voor voertuigen met ABS
AG	Voor voertuigen met automatische transmissie
DOV	Dubbele ontsteking, per cilinder zijn 2 verschillende bougies nodig
ERL	Voor voertuigen met verhoogd vermogen
EU2	Voor voertuigen met uitlaatgasemissienorm EURO 2
EU2	Niet voor uitlaatgasemissienorm Euro 2
FE	Ontstoord
GS	Voor voertuigen met handgeschakelde transmissie
KAT	Voor voertuigen met katalysator

KAF	Voor voertuigen zonder katalysator
LEN	Voor motor met normaal vermogen
LET	Voor motor met laag vermogen
STT	Standaard type
TW	Ingebouwd product moet aan het voertuig of de motor gedetecteerd worden.
WW	In optie
XJB	Korte schroefdraad
XJC	Lange schroefdraad



Artikelnummer



ZB-verpakking



EAN-code ZB-verpakking



Tegenoverstelling



Paginaverwijzing



Elektrode-afstand in mm



Ontstoord



Schroefdraad



Sleutelwijdte



Schroefdraadlengte



Elektrodemateriaal



Vlakke afdichtzitting



Bougie



Soort aansluiting



Mofa



Motorfiets



Scooter



Driewieler pick-up



Quad



Datum/ Ingebouwd van .. tot ..



Aantal cilinders



ABS	För fordon med ABS
AG	För fordon med automatlåda
DOV	Dubbeltändning, för varje cylinder behövs 2 olika tändstift
ERL	För fordon med förhöjd effekt
EU2	För bilar med avgasstandard Euro 2
EU2	Ej för avgasstandard Euro 2
FE	Avstörd
GS	För fordon med manuell växellåda
KAT	För katalysatorbilar

KAF	För bilar utan katalysator
LEN	För motor med normaleffekt
LET	För motor med låg effekt
STT	Standard Typ
TW	Monterad produkt måste identifieras på bilen eller motorn.
WW	Valfritt
XJB	Kort gänga
XJC	Lång gänga



Artikelnummer



Gör det själv-förpackning



EAN-kod SB-förpackning



Jämförelse



Sidhänvisning



Elektrodstånd i mm



Avstörd



Gänga



Nyckelvidd



Gänglängd



Elektrodmateriel



Plantätningssäte



Tändstift



Anslutningssätt



Moped



Motorcykel



Skoter



Trehjulingslastflak



Quad



Datum/monteringstidpunkt



Cylinderantal



ABS	Pro vozidla s ABS
AG	Pro vozidla s automatickou převodovkou
DOV	Dvojité zapalování, na válec jsou třeba 2 různé zapalovací svíčky
ERL	Pro vozidla se zvýšeným výkonem
EU2	Pro vozidla s emisní normou Euro 2
EU2	Ne pro emisní normu Euro 2
FE	Odrušeno
GS	Pro vozidla s manuální převodovkou
KAT	Pro vozidla s katalyzátorem

KAF	Pro vozidla bez katalyzátoru
LEN	Pro motor s normálním výkonem
LET	Pro motor s nízkým výkonem
STT	Typ Standard
TW	Namontovaný výrobek musí být uveden na vozidle nebo na motoru.
WW	Volitelné
XJB	Krátký závit
XJC	Dlouhý závit



Objednací číslo



Samoobslužné balení



Kód EAN balení SB



Porovnání



Odkaz na stránky



Vzdálenost elektrod v mm



Odrušeno



Závit



Otvor klíče



Délka závitů



Materiál elektrod



Ploché těsn. sedlo



Zapal. svíč.



Druh přípojky



Mofo



Motocykl



Skútr



Tříkolka valník



Čtyřkolka



Datum/období montáže



Počet válců



ABS	для автомобилей с антиблокировочным устройством
AG	для автомобилей с автоматической коробкой скоростей
DOV	Двойное зажигание, на цилиндр требуется 2 различных свечи зажигания
ERL	Для транспортных средств с повышающей мощностью
EU2	Для автомобилей с нормой токсичности ОГ Euro 2
EU2	Не для нормы токсичности ОГ Euro 2
FE	защищено
GS	для автомобилей с коробкой передач с ручным управлением

KAT	для автомобилей с катализатором
KAT	для автомобилей без катализатора
LEN	Для двигателя с расчетной мощностью
LET	Для двигателя с низкой мощностью
STT	Тип Standard
TW	Встроенное издание должно определяться в автомобиле или двигателе.
WW	на выбор
XJB	резьба
XJC	длинная резьба



Номер для заказа



Упаковка для магазинов самообслуживания



EAN-код SB-упаковка



Сравнение



Сторонняя ссылка



Расстояние между электродами в мм



Защищено



Резьба



Ширина зева ключа



Длина резьбы



Материал электрода



Плоская плотная посадка



Свеча зажигания



Способ подключения



Мопед



Мотоцикл



Мотороллер



Трёхколёсный пикап



Quad



Дата / Период сборки



Количество цилиндров

